



High Point Furniture Industries, Inc.

2017 Price Book

Effective 01/02/17



TABLE OF CONTENTS

GENERAL REFERENCES

How to Order	1
Lead Times	2
Quick Ship	3
Warranty	4
Zones	5
Term and Conditions	6
Finishes	8

CASEGOODS

Hyperwork	10
Hyperwork Education	45
Atlas	49
Vision	69
Vitality	83
Bedford	93
Wyndham	102
Accessories	108

MEETING TABLES

Matrix	117
Hyperwork	122
Atlas	125
Vitality	126
Bedford	128
Meeting Accessories	131

POWERFLEX

134

TRAINING TABLES

Clique	136
Deflection	139

BREAKROOM TABLES

Milan	140
-------	-----

OCCASIONAL TABLES

Malibu	142
Trados Metal	143
Eve	144
6700 Series	145
Hyperwork	145
9100 Series	146
Marquet	146
Bedford	147

SEATING REFERENCES

FedEx Ground Shipping	148
Leather	150
Graded-In Mills	151
Mayer Fabrics	152
C.F. Stinson	153
Momentum	155
NOW Quick Ship Upholsteries	156
QS Quick Ship Upholsteries	157
Technical Specification	158
Technical Bulletin #133	159
COM/COL Instructions	160
Ergonomic Specifications	162
Seating Finishes	164

LOUNGE SEATING

Eve	167
Evette	177
Accompany	179
Genesis	190
Flex Tiered	192
Flex Ottomans	193
7300/7400	196
Steps	199
Himalaya	202
Claudia	205
Lauren	207
Rebecca	208
Scarlet	209
Kimberly	210
9100 Series	212
Traditional	214
Chesterfield	217

OFFICE SEATING

Nexstep	219
Cougar	222
Puma	223
Cheetah	224
Leaders	226
Scoop	231
1200 Series	235
Trifecta	238
Quick Silver	241
3900 Series	244
Traditional	246
Scoop Traditional	253
Quick Silver Traditional	256

GUEST/GANGING SEATING

Contempo	258
Unos	264
Trados	267
Trados Metal	270
700 Series	273
Corbel	274
Scoop	275
9118/9128	277

BREAKROOM SEATING

Stax	279
Milan	281

HEALTHCARE

Hannah Patient Chair	287
Haley Recliners	292
Harmony Day Beds	299
Helix Dr. Stools	302

AUTHORIZED DEALERS ONLY

HPFi sells to authorized dealers and resellers of office furniture, and only Authorized HPFi Dealers can place orders. To become an Authorized Dealer, you must:

- Have written approval by both the local HPFi Sales Representative and HPFi Sales Management
- Establish a line of credit (or pay for all orders with certified check, Visa or Mastercard or cash prior to order entry)
- Be prepared when BB & T Factors (who acts as the HPFi credit department) contacts you for credit information. Time is of the essence in supplying this data. Purchase Orders cannot be entered until credit processing is completed and a line of credit is established. Allow up to two (2) weeks for processing.

PURCHASE ORDERS

To ensure prompt processing of your order, all purchase orders must clearly state the following:

- Dealer Name
- Purchase Order Number
- Contact Name and Phone Number
- Complete Bill To and Ship To Addresses
- Complete Product Numbers, including:
 - Model/Finish Number + Options (casegoods)
 - Model Number + Finish + Options + Upholstery Pattern/Color Number/Color Name (seating)
- Quantities

ORDER PLACEMENT

All orders may be mailed, faxed or e-mailed to HPFi as follows:

Mail: **HPFi**
1104 Bedford Street
High Point, NC 27263

Fax: **800.231.6784**

E-mail: **orderentry@HPFi.com**

ORDER ENTRY

We want to process your order on a timely basis and will make every attempt to enter all orders within two (2) business days of receipt. Inability to clearly read an order or the lack of any of the above information will delay order entry. Clarification of any missing or unclear information will be promptly requested via fax or e-mail. Once all information is received, HPFi will complete order entry.

- Your discount and net prices will be automatically calculated. **If your purchase order prices do not match HPFi calculated net prices, you will be notified via e-mail, telephone or fax. It is the customer's responsibility to review Order Acknowledgements for accuracy and pricing. Any corrections must be noted immediately and e-mailed or faxed to your Customer Service Representative at 336.434.5280.**
- Minimum order \$500 net, except for parts.
- Only credit-approved orders are released to production. If an order is held due to credit reasons, you will be informed via fax or e-mail.
- Published lead times start on the first business day **after** entry of a clean, credit-approved order.

HPFi has made every effort to ensure the accuracy of this Price List. HPFi cannot be responsible for typographical errors. Pricing and product specifications are subject to change and can be verified through our HPFi Customer Service Department at 800-447-3462, ext. 2120.

Choose from three (3) lead time options: **QS** Quick Ship, **NOW** Quick Ship or Standard Lead Time. Lead times are measured from the date the order is entered (complete and credit-approved) to the date the order ships. Transit time is not included as it varies by carrier and destination.

STANDARD LEAD TIME

Assigned to all orders unless the purchase order specifically requests and meets quick ship **QS** or **NOW** program requirements. Large orders, custom features, COM upholstery, factory-installed options, combination upholsteries and any other special product requests may increase lead time.

Standard lead time is three (3) to four (4) weeks. Orders placed to ship in standard lead times are normally acknowledged to ship twenty (20) manufacturing days after the date of order entry. HPFi may elect to ship prior to the acknowledged date. Occasionally, due to seasonal demand or holiday schedules, standard lead times may be adjusted. To verify lead time, contact your Customer Service Representative.

Hyperwork and Wyndham items are available with high pressure laminate tops in a six (6) to eight (8) week lead time in the finishes listed for those individual series. See pages 10 and 102.

Order Acknowledgements indicate the approximate ship date you can expect. Most orders ship complete by the indicated date. However, we cannot guarantee every order will ship by the date acknowledged. Occasionally, due to circumstances beyond our control, we may ship after the acknowledged date. We will make every effort to anticipate and inform you in advance of any late shipment situations.

QUICK SHIP LEAD TIMES

HPFi offers the fastest lead-time on breadth and depth of product in the furniture industry. Orders must be complete and credit approved to be released to production. HPFi offers two (2) Quick Ship programs outlined in detail on page 3:

Casegoods Quick Ship – Casegood products in this Price Book are marked with the **QS** symbol. Only the shaded model numbers and finishes indicated as Quick Ship are available in Quick Ship lead time.

Seating Quick Ship – All seating products are available in Quick Ship in standard finishes and Quick Ship upholsteries. **NOW** upholsteries are listed on page 156. **QS** upholsteries are listed on page 157. Any item ordered with installed options will not be available for either quick ship program.

Quick Ship orders must have:

- **QS** or **NOW** clearly stated/marked on the purchase order.
- Quick Ship items only on the purchase order requesting **QS** or **NOW**. If there are models of **QS** or **NOW** and Standard lead times on same order, the order will ship at standard lead-time.
- A limit of 8 each of any **QS** or **NOW** items per day. Quick Ship orders exceeding the maximum for the same item cannot be ordered consecutively in the same week without prior approval from an HPFi Customer Service Representative. See **ORDER QUANTITIES** on page 3 for additional information.

Please add additional time for holidays.

GOT A TIGHT DEADLINE?

HPFi will ship any of our casegoods marked **QS** and any seating products covered with our extensive **QS** upholsteries program in three (3) to five (5) business days after the credit approved order is entered.

Casegood and occasional table products selected for the **QS** Quick Ship program are noted by the **QS** symbol. The Quick Ship finish and pull options are designated in a note under model number.

All seating items are available for Quick Ship lead time only in the patterns and colorways listed within the **QS** upholsteries listed on page 157 or the patterns within the **NOW** Quick Ship upholsteries listed on page 156. All other graded-in upholsteries are available at standard lead times. Items ordered with installed options will not be available for Quick Ship.

QUICK SHIP ORDER TAGS

Your order must be clearly marked with **QS** or **NOW** and include only those items in their respective Quick Ship programs. HPFi will make every effort to ship all credit-approved **QS** orders in three (3) to five (5) business days and **NOW** orders in seven (7) to ten (10) business days from the date that a "clean" order is entered and credit-approved. If an order includes both **QS** and **NOW** products, the **NOW** lead time will apply.

ORDER QUANTITIES

The maximum order size for both the **QS** or **NOW** program is 8 pieces of any item (per dealer, per day) and \$30,000 list regardless of the number of items. Orders for the same item(s) cannot be ordered consecutively in the same week without prior approval from HPFi. Should your product needs exceed these maximums, please contact your Customer Service Representative for manufacturing time, e.g. 12 **QS** items instead of 8. HPFi may be able to ship 12 items in 6 days, etc.

HPFi reserves the right to limit quantities based on materials' availability.

CHANGES/CANCELLATIONS

CASEGOODS

To request a change or cancellation for a casegood products order, contact Customer Service to verify ability to adjust original order. If a change is made, the cycle of the number of business days for **QS** items begins anew from the date the change was made. No cancellations can be allowed once an order ships. HPFi is not responsible for any loss of sale or contract resulting from failure to ship within three (3) to five (5) business days.

SEATING

Due to the breadth of upholsteries and finishes available, seating items cannot be changed or cancelled once the Quick Ship order has been entered.

QUICK SHIP UPHOLSTERIES

A complete list of all **QS** upholsteries is listed on page 157. **NOW** upholsteries are listed on page 156.

PAYMENT TERMS

Net thirty (30) days from date of invoice.

DIRECT ALL CORRESPONDENCE TO

Mail: **HPFi**
1104 Bedford Street
High Point, NC 27263

Fax: **800.231.6784**

Phone: **800.447.3462**

E-mail: **orderentry@HPFi.com**

Website: **www.HPFi.com**

Subject to the terms, conditions and exceptions stated below, High Point Furniture Industries, Inc. ("HPFi"), warrants that each new finished product, separate component or part ("Product") will be free from defects in material and workmanship, when subject to normal commercial usage, for so long as the Product is owned by the original purchaser. If the Product is sold by HPFi to a retailer or dealer, the "original purchaser" shall be the purchaser of the Product from the retailer or dealer. Otherwise, the "original purchaser" shall be the purchaser of the Product from HPFi. The original purchaser may not assign this warranty to any other person or entity.

EXCEPTIONS:

High-Wear Parts - High-wear parts such as glides, gas cylinders, casters, ergonomic chair components, polymer-based components, and user-adjustable work surface mechanisms are warranted against defects in material and workmanship only for a period of five years (three years on recliner mechanisms and casters) from the date on which the Product is sold by HPFi or until the product is no longer owned by the original purchaser, whichever is the shorter time period.

Veneer Finishes - Veneer finishes are warranted against defects in material and workmanship only for a period of three years from the date on which the Product is sold by HPFi or until the product is no longer owned by the original purchaser, whichever is the shorter time period.

Electrical Components - Electrical components are not warranted by HPFi, but may have warranties from the electrical component manufacturer.

Upholsteries - Careful consideration is given to our presentation of upholstery offerings. The upholsteries we offer feature the best in appearance, durability and value. However, we have no control over the environment, cleaning or other conditions which may affect colorfastness or durability. Puddling may occur as a result of certain climate conditions and/or the natural stretch inherent in upholsteries and is not a flaw in the upholstery or manufacturing process. HPFi cannot predict or be held responsible for upholstery performance in an installation and does not guarantee against puddling. Customer's Own Materials (COM) selected by and used at the request of a customer are not warranted. We cannot warrant upholsteries beyond the stated warranty provided by the specific upholstery supplier for that specific material whether it is an HPFi core supplier or COM.

CUSTOMER'S OWN MATERIAL:

If HPFi agrees to use the customer's own material (COM) or leather (COL) on HPFi brand products, or build a custom product:

- HPFi shall have no responsibility for the condition, quality, value, performance, physical properties or any other aspect of the COM or COL.

- HPFi shall have no liability for any damages, injuries or losses to the customer or to any third party that shall be caused by any COM or COL and the customer shall hold HPFi harmless for all liability.

For complete COM/COL order requirements and warranty information see the HPFi COM/COL Order Form on page 161.

EXCLUSIONS:

This warranty does not apply and no other warranty applies to:

- Normal wear and tear, which is to be expected over the course of ownership.
- Damage caused by the carrier in-transit, which will be handled under freight policy.
- Damage caused by or during installation.
- Modifications or attachments to the Product that do not have the prior written approval of HPFi.
- Products that are not installed or used or maintained in accordance with Product instructions and warnings.
- Damage caused by neglect or misuse of a Product.
- Products used for personal or household use (all products are intended for commercial usage) or for rental purposes.
- Normal Commercial Usage - The Products are designed and manufactured for normal commercial usage. Normal commercial usage for seating is defined as the equivalent of a single shift, forty (40) hour workweek. To the extent that a Product is used in a manner exceeding normal commercial usage, the warranty will be invalidated or HPFi may, at its option, elect to reduce the applicable warranty period on a pro-rated basis.
- Chairs designated 24/7 have a warranty of five (5) years.
- Color Variations and Finishes - Some natural variations occurring in wood, leather or other natural materials are inherent to their character, and cannot be avoided. Therefore they are not considered defects in material or workmanship and are not the basis for a warranty claim. HPFi does not warrant the color-fastness or matching of colors or grains or textures of such materials.

EXCEPT AS SET FORTH ABOVE, HPFI MAKES NO OTHER EXPRESS WARRANTIES WITH RESPECT TO ITS PRODUCTS. HPFI MAKES NO IMPLIED REPRESENTATIONS OR WARRANTIES WITH RESPECT TO ITS PRODUCTS, THEIR CONDITION, MERCHANTABILITY, FITNESS FOR ANY PARTICULAR PURPOSE OR USE BY THE PURCHASER. HPFI FURNISHES THE ABOVE LIMITED EXPRESS WARRANTY IN LIEU OF ALL OTHER WARRANTIES, EXPRESSED OR IMPLIED, INCLUDING THE WARRANTIES OF MERCHANTABILITY AND FITNESS FOR A PARTICULAR PURPOSE. NO ORAL REPRESENTATIONS OR SAMPLES PROVIDED BY HPFI TO ANY RETAILER, DEALER OR PURCHASER WILL CREATE ANY EXPRESS OR IMPLIED WARRANTIES WITH RESPECT TO PRODUCTS SOLD BY HPFI.

REMEDIES:

If any defect in the workmanship and material of any Product appears within the applicable warranty period, HPFi will, at its option, repair or replace the Product, at no charge, upon examination of the Product and verification by HPFi or its authorized representative of the defect and of compliance with the warranty requirements and conditions. The Purchaser must provide such cooperation and information as HPFi or the authorized representative may reasonably request to process the warranty claim.

IN THE EVENT OF ANY DEFECT IN ANY PRODUCT SOLD BY HPFI OR ANY BREACH OF THE LIMITED EXPRESS WARRANTY DESCRIBED ABOVE, THE SOLE REMEDY FOR SUCH DEFECT AND/OR BREACH SHALL BE AS STATED IN THIS PARAGRAPH, AND IN NO EVENT SHALL THE DEALER OR RETAILER THAT PURCHASED THE PRODUCT FROM HPFI OR THE ORIGINAL PURCHASER OF THE PRODUCT FROM THE DEALER OR RETAILER, BE ENTITLED TO RECOVER FROM HPFI ANY DAMAGES, INCLUDING DIRECT, CONSEQUENTIAL OR INCIDENTAL DAMAGES, LOST PROFITS, DOWNTIME OR OTHER DAMAGES OF ANY NATURE WHATSOEVER ARISING FROM BREACH OF WARRANTY OR THE CONDITION, FUNCTION OR USE OF THE PRODUCT.

APPLICATION OF CURRENT WARRANTY AND PRIOR WARRANTIES:

This express limited warranty applies only to Products manufactured and sold by HPFi on or after April 1, 2001. Products manufactured and sold by HPFi before April 1, 2001 were covered by the warranty in effect at that time and have expired. Further information concerning terms and conditions of prior warranties are available upon request to HPFi.

These warranties are made by HPFi only to authorized dealers and retailers acquiring Products directly from HPFi and the original purchaser of the Product as defined above.



 ZONE 3

 ZONE 2

 ZONE 1

PALLETIZATION

Casegood products ordered in LTL quantities may be palletized prior to shipment for enhanced protection and further assurance of safe delivery. Pallets are one per product, in most cases, and sized per casegood product. Seating is not palletized. All pallets are \$24 net per pallet. Add 40 lb. to the ship weight per pallet. Contact your Customer Service Representative for additional details and a quote.

Palletization is not generally offered on truckload quantities or volume shipments of 14 feet or more. Contact Customer Service for a custom quote if this option is required.

All orders are subject to the terms and conditions presented in this price list. The term HPFi refers to High Point Furniture Industries, Inc., High Point, North Carolina - USA.

TERMS

Payment for all orders is due Net thirty (30) days from date of invoice.

LEASING

Please contact HPFi Sales to learn about leasing options.

CONDITIONS OF SALE

Possession and/or distribution of this price list or HPFi catalogs does not in itself constitute an offer to sell. Orders can be received only from authorized HPFi dealers.

Accepted orders will be acknowledged in writing with approximate shipping dates. Orders will be invoiced at prices prevailing at time of order entry.

PRICES

This price list contains Zone pricing, including freight prepaid and allowed to the 48 contiguous states; freight and/or fuel surcharges as dictated by carriers may apply. All prices shown are suggested retail prices. Prices, specifications and materials are subject to change without notice.

SHIPPING

All HPFi products ship as follows: **F.O.B. ORIGIN, HIGH POINT, NC - USA, FREIGHT PREPAID** - this means that ownership and the responsibility of the merchandise becomes that of the buyer upon delivery to the freight company. The zone list prices shown herein reflect the delivered price to the 48 contiguous states. It includes **dock-to-dock** shipment, with normal delivery accomplished in three (3) to ten (10) business days, after shipment.

HPFi reserves the right to select the carrier and routing. The transportation company assumes full responsibility for safe delivery upon acceptance of the shipment from HPFi.

Special Shipping Services:

Shipments requiring special services (such as expedited delivery, delivery appointments, non-dock, residential, school, military base, inside delivery, etc.) are not included in this freight prepaid pricing. The additional charges for these special shipments will be quoted on a pre-pay and add, case-by-case basis. Contact Customer Service for details.

Orders of less than 500 lbs. will be assessed a minimum freight charge of \$75.00 net per order (excluding items shipped via small package ground service). Shipments outside the USA are prepaid to point of departure.

Acknowledged ship dates are our best estimates of when the product will leave the factory. Actual ship dates may vary.

ORDERING

See the **How To Order** page. For clarification of any question pertaining to ordering, contact HPFi's Customer Service Department prior to placing the order.

PACKAGING

Prices quoted herein include normal packaging. HPFi products are carefully inspected and are packed one to a carton, except where indicated. All packaging conforms to or exceeds specifications as outlined in the Uniform Freight classification. Special packing (e.g. palletization) if specified, requires an upcharge.

DRAWER AND TOP OPTIONS

Inset drawers and thicker tops available at 20% upcharge. Contact Customer Service Department for details.

SPECIAL PRODUCT ORDERS

We welcome the opportunity to quote special products. Any changes in look, build, finish or options must be processed through the Custom Product Order Program. Please contact our Customer Service Department for pricing and lead times.

NOTE: Due to the cost of creating custom products, a minimum charge per order may apply. Special product orders are non-returnable and non-refundable. A 50% deposit may be required with order placement for special products.

IN-TRANSIT DAMAGE

HPFi does not own or operate its own transportation equipment. All shipments made by HPFi are made using third party carriers or customer transportation. HPFi manufactures and packages its products to withstand the normal handling incurred during transportation to provide for safe transit. HPFi ships only top quality undamaged merchandise. Title and ownership of merchandise is transferred to the dealer/customer when the freight carrier signs the bill of lading. The carrier assumes complete responsibility for delivering merchandise to the consignee in good condition.

It is the responsibility of the dealer/customer to inspect all merchandise upon delivery to the customer-designated ship-to address. Any visible damage upon delivery must be noted on the bill of lading when the merchandise is signed for. Freight carriers will accept responsibility for damage which upon their inspection they deem to be their fault. It is the buyers' responsibility to file freight claims with the responsible carrier.

HPFi will provide advice and assistance to its customers with the freight claim process and will use its influence to encourage carriers to accept their responsibility.

Concealed Damage Claims must be filed within 5 days of delivery and original cartons must be retained.

Most carriers will not accept a claim for concealed damage if the claim is made more than 5 days after receipt, or if the merchandise is moved from the original delivery location. It is the buyers' responsibility to file claims for concealed damage with the freight carrier.

RETURN AUTHORIZATION

An error made by HPFi resulting in shipment of an incorrect or defective product may be allowed for return to HPFi. **Such returns require prior authorization from the HPFi Customer Service Department.**

Please call 800.447.3462 to request a Return Authorization and shipping instructions. **All returned products must be properly packaged to ensure safe transit.**

Certain products may not be returned under any circumstances:

- Any non-defective upholstered furniture
- Any seating product made using customer owned material (COM or COL)
- Any seating or casegoods product made using special materials or custom finishes
- Any seating or casegoods product made to custom specifications of customer

Returns for any other reason will only be allowed at the sole discretion of HPFi. All returns will be assessed a 30% restocking charge plus the cost of return freight.

Return Authorizations (R.A.s) are valid for 45 days from the issue date. Authorized returns must have the R.A. number clearly marked on all cartons and the bill of lading. All cartons must arrive at the HPFi designated ship-to location within 45 days of the authorization. Failure to return merchandise within 45 days will result in the cancellation of the Return Authorization and demand for payment.

RETURN GUIDELINES

- Merchandise must be returned in appropriate packaging to ensure safe transportation. Use the original packaging or the packaging from the replacement units including all inner and outer packaging to repack the returned product. If return is not HPFi's responsibility, repackaging and restocking charges will apply.
- All casegoods must be strapped Top-Side-Up to correct size pallet for return. DO NOT place upside down.
- All shipping documents and product cartons must be clearly marked with HPFi's Return Authorization number.
- You must use the carrier noted on the Return Authorization.
- Failure to comply with requirements will void the Return Authorization; no money will be credited; full payment will be due HPFi.

All returned product shipments received by HPFi will be promptly inspected to verify:

- The product was authorized for return
- The accuracy of counts/quantity
- The reason for return is valid

If approved, HPFi will issue credit to the customer less (where applicable) the 30% restocking charge, return freight and any costs incurred by HPFi to return the products to like new condition.

CANCELLATIONS

Acknowledged orders are considered firm and final. No cancellations or changes will be allowed without the express written authorization of HPFi management. Changes may be subject to additional charges. Upholstered items may not be cancelled after the fabrics or other upholstery cover material has been cut. Quick Ship orders cannot be cancelled.

REPAIR CHARGES

Authorization must be obtained from HPFi's Customer Service Department prior to incurring repair charges if HPFi is expected to pay any portion of the costs.

CORRESPONDENCE

Direct all correspondence to:

HPFi
1104 Bedford Street
High Point, NC 27263

Phone: **336.431.7101**
800.447.3462

Customer Service / Order Desk
 Fax: **800.231.6784**

E-mail: **orderentry@HPFi.com**

CASEGOOD FINISHES BY SERIES

	Black	Boardwalk (Textured)	Driftwood (Textured)	Espresso	Graphite	Mahogany	Maple	Shoreline (Textured)	Windsor Cherry
Laminate									
Atlas	**	**	**	**	**	•	•	**	•
Bedford (HPL top)						•			•
Clique Tables (1 1/8" top)	•	•	•	•	•	•	•	•	•
Conference Tables (1 1/8" top)	•	•	•	•	•	•	•	•	•
Deflection Tables (1 1/8" top)	•	•	•	•	•	•	•	•	•
Hyperwork	•	•	•	•	•	•	•	•	•
Milan Tables (1 1/8" top)	•	•	•	•	•	•	•	•	•
Occasional Tables	•	•	•	•	•	•	•	•	•
Vision	•	•	•	•	•	•	•	•	•
Vitality (HPL top)						•			•
Wyndham						•			•

FINISH COORDINATION

** Base/Undercarriage Only

Casegoods	Seating	
Natural Maple	FM	Natural
Windsor Cherry	WC	Windsor Cherry
Mahogany	MAH	Mahogany
Driftwood	DW	Driftwood
Black	BLK	Black
Espresso	ESP	Espresso
Boardwalk	BW	Boardwalk
Shoreline	SL	Shoreline

The HPFi Finishes Card provides comprehensive visual reference to veneer, laminate and seating finishes for quick, easy selection. Ask your sales representative for your copy.

For Seating Finish Chart see page 164.

LAMINATE CASEGOODS



CHARACTERISTICS

Hyperwork modular casegoods offer extensive choice for design flexibility, adapting to various building layouts, business structures and personal work requirements. The details below will help you understand the key components of Hyperwork.

FINISHES

- ALL COLORS ARE THE SAME PRICE -

All finishes are thermally fused laminates unless otherwise noted. **A high pressure laminate top option is available for a 15% pricing upcharge and a six-week lead time will apply.**

High pressure laminate tops are only offered in **Windsor Cherry** and **Mahogany**. Contact your customer service representative to discuss specific high pressure laminate needs and to obtain delivery quotes. To order high-pressure laminate tops on Hyperwork items in Windsor Cherry or Mahogany, add 4 after the H and add 15% to the list price of the item. **Example:** H4WM720

FINISH COLORS

BW Boardwalk	M Mahogany
DW Driftwood	SL Shoreline
E Black	WC Windsor Cherry
FM Natural Maple	X Espresso
GP Graphite	

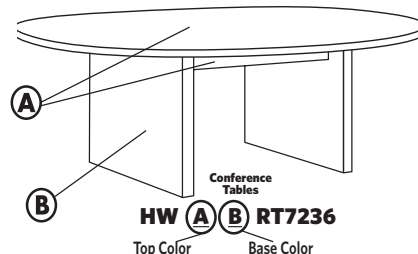
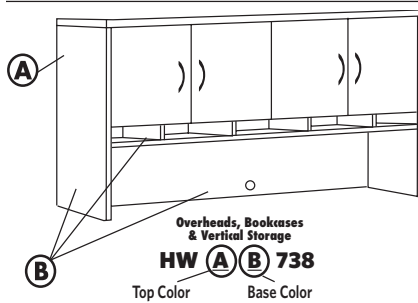
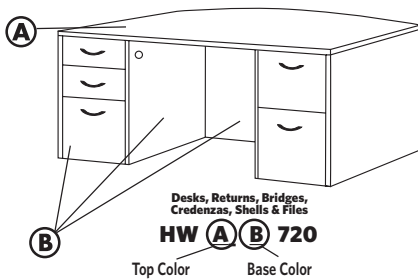

PEDESTALS & FILE CABINETS

All cases are ¾"-thick core with thermally fused laminate on both sides and full 3 millimeter PVC AdvantEdge banding. Choose full or ¾ height pedestals. Full modesty panels included. Units fully assembled with dowels, glue, metal brackets, screws and mechanical fasteners.

TOPS

All tops are 1" thick with thermally fused laminate surface, proper backing and full 3 millimeter PVC AdvantEdge banding as required. All bridge and return tops feature common grain direction with connecting units. High pressure laminate tops available.

PULL OPTIONS

Drawer/door pulls all constructed of solid metal. When ordering, use the corresponding pull designator at the beginning of the model number.

HW Brushed Chrome
HE Ebony
HB Bright Brass
HD Oval Nickel
HV T-Bar Nickel

DRAWERS

All drawer fronts are constructed of ¾" thick core with thermally fused laminate on both sides and full 3 millimeter PVC AdvantEdge banding as required. Drawer sides are ½" thick vinyl wrap with oak grain pattern. Drawer bottoms are 1/8" thick hardboard with oak grain pattern.

- All box and center drawers suspended on smooth-action steel, ball-bearing slides ¾" extension
- File and lateral file drawers mounted on heavy-duty, ball-bearing, full-extension slides
- All file and lateral file drawers constructed for suspended filing with 25 lb. maximum weight for bottom-loading
- Drawers constructed with 5 sides for extra strength and durability. Drawer front is the fifth side and is removable for field-repair or hardware additions

FILING

- All file drawers include pre-installed, black filing hardware with easy-adjust crossbar
- All file drawers accommodate letter-size filing front-to-back and letter- or legal-size filing side-to-side
- All lateral file drawers accommodate letter or legal-size filing side-to-side and letter or legal size filing front-to-back

WIRE MANAGEMENT

See features for number of grommets and location. Additional 2.5" grommets can be added for extended wire management capability at \$106 list per grommet. Add G after SKU number. Includes factory cut and installed grommet and black sleeve. Specify location with order.

PAPER FEED SLOT

Factory installed 17" x 2" paper feed slot with black protective sleeve can be added to any shell. Add PS after SKU number and add \$140 to list price. Specify location.

LOCKS

- Desk/credenza pedestals feature single-key side locking, keyed alike
- Two drawer lateral file features single-key front locking and counter weight
- Four-drawer lateral file features central locking and anti-tilt mechanism
- Two and four-drawer lateral files keyed alike
- All locks are keyed identical unless otherwise specified
- 'Key Different' option is \$21 list upcharge per lock. Locks/cores packaged to customer requirements
- Additional lead time for 'Key Different'
- For optional locking on overhead storage units with wood doors and no inserts, add **Y** to the end of the model number and add \$150 to the list price of units with four doors or two doors not adjoining. Add \$75 for units with two adjoining doors.

QUICKSHIP

Quick Ship is not available on any items ordered with option.

ACCESSORIES *Factory Installed*

Certain accessories can be ordered installed prior to shipment. Add letter designator (C or K) at end of the desk or credenza model number:

C Center Drawer	<i>Example: HWWC720C</i>
K Keyboard Platform	<i>Example: HWWC660K</i>
T Task Light	<i>Example: HWWC738T</i>

PANELS

End panels are 1" thick core with thermally fused laminate on both sides and full 3 millimeter PVC AdvantEdge banding as required. Full modesty panels are ¾" thick core with thermally fused laminate on both sides and full 3 millimeter PVC AdvantEdge banding as required. Heavy-duty adjustable nylon leveling glides in 5" steel plate on all units.

PACKAGING

All units are properly packed in heavy-duty cartons with reinforced corner pads. All packaging conforms to, or exceeds, specifications as outlined in the Uniform Freight Classification.

PALLETIZATION

See page 5.

CARE AND CLEANING INSTRUCTIONS

Normal cleaning: Clean using a soft cloth and a good window cleaner which contains no ammonia, followed by wiping dry using a dry soft cloth.

Specifications subject to change without notice.

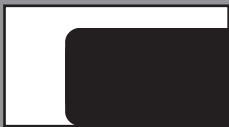

Configurations

Zone Pricing	1	2	3
--------------	---	---	---

Executive U Unit

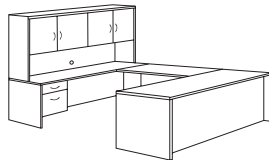

72" x 108" x 65.5"

Description	Model Number	QT	FRT.Class	Cubic FT	Ship Weight				
Right Pedestal Desk	H_ _721R 72" x 36" x 29"	1	200	51.6	250	1397	1418	1439	
Bridge	HW_485 48" x 24" x 29"	1	100	4.0	66	484	491	499	
Left Pedestal Credenza	H_ _725L 72" x 24" x 29"	1	125	35.7	184	1210	1228	1246	
Overhead Storage Unit with Doors	H_ _737 72" x 16" x 36.5"	1	125	33.6	221	1376	1397	1417	
Task Light	TL2P 19.5" x 3.25" x 1.25"	1	200	1.0	3	124	126	128	
Total:						724	4591	4660	4729

Executive Office with Extra Storage



144" x 108" x 65.5"

Description	Model Number	QT	FT.Class	Cubic FT	Ship Weight				
Double Pedestal Bow Front Desk	H_ _720B 72" x 36" x 29"	1	200	51.6	280	1851	1879	1907	
Computer Credenza	H_ _744 72" x 24" x 29"	1	110	35.7	275	1450	1472	1494	
Overhead Storage Unit with Doors	H_ _737 72" x 16" x 36.5"	1	125	33.6	221	1376	1397	1417	
Five Shelf Bookcase	HW_65 36" x 16" x 65.5"	1	125	31.8	205	993	1008	1023	
Storage Cabinet with Lateral File	H_ _65STOR 36" x 24" x 65.5"	1	125	40.3	300	1915	1944	1972	
Total:						1281	7585	7700	7813

Executive U Unit with Curved Corner Desk

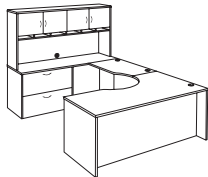

72" x 108" x 65.5"

Description	Model Number	QT	FT.Class	Cubic FT	Ship Weight				
Curved Corned Desk	H_ _462R 72" x 42-30" x 29"	1	200	58.9	299	1942	1971	2000	
Asymmetrical Bridge	HW_495L 42" x 24" x 29"	1	100	4.0	56	537	545	553	
Left Lateral File Credenza	H_ _733L 72" x 24" x 29"	1	125	35.7	229	1539	1562	1585	
Overhead Storage Unit with Doors and Paper Storage Shelves	H_ _738 72" x 16" x 36.5"	1	125	33.6	240	1754	1780	1807	
Total:						824	5772	5858	5945

Computer Station with Corner Module

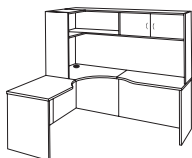

72" x 72" x 65.5"

Description	Model Number	QT	FRT.Class	Cubic FT	Ship Weight				
Corner Module	HW_448 36" x 36" x 29"	1	200	27.2	122	746	757	768	
Left Asymmetrical Shell	HW_193624L 36" x 24" x 29"	1	200	19.8	105	595	604	613	
Right Asymmetrical Shell	HW_193624R 36" x 24" x 29"	1	200	19.8	105	595	604	613	
Left Corner Hutch with Doors	H_ _CH7236L 72" x 36" x 36.5"	1	125	45.2	253	1875	1903	1931	
Total:						585	3811	3868	3925

Cluster Work Station (4 People)



144" x 144" x 65.5"

Description	Model Number	QT	FT.Class	Cubic FT	Ship Weight				
Computer Corner Desk Left Pedestal	H_ _451L 72" x 36/24" x 29"	4	200	51.6	269	1942	1971	2000	
Right Pedestal Compact Return	H_ _452R 36" x 24" x 29"	4	110	21.5	132	947	961	975	
Open Overhead Storage Unit	HW_717 72" x 16" x 36.5"	4	125	33.6	181	1173	1191	1208	
Group Total:						2328	16248	16492	16732

UNIT	KNEESPACE	OVERHANG
72" x 36" Desk	38-1/4"	7"
72" Double Pedestal Desk	38-1/4"	13"
66" Double Pedestal Desk	32-1/4"	7"
60" Double Pedestal Desk	26-1/4"	7"

UNIT	KNEESPACE	OVERHANG
72" Double Pedestal Credenza	38-1/4"	n/a
66" Double Pedestal Credenza	32-1/4"	n/a
72" Curved Corner Desk	n/a	5"

CONTEMPORARY LAMINATE

MultiStation with Privacy (2 People)



144" x 72" x 65.5"

Description	Model Number	QT	FT.Class	Cubic FT	Ship Weight	Zone Pricing				
						1	2	3		
Left Pedestal Computer Corner Desk	H_451L 72" x 36/24" x 29"	2	200	51.6	269	1942	1971	2000		
Right Pedestal Compact Return	H_452R 36" x 24" x 29"	2	110	21.5	132	947	961	975		
Open Overhead Storage Unit	HW_717 72" x 16" x 36.5"	2	125	33.6	181	1173	1191	1208		
Group Total:						213.4	1164	8124	8246	8366

Double Workstation (2 People)



180" x 72" x 65.5"

Description	Model Number	QT	FT.Class	Cubic FT	Ship Weight	Zone Pricing				
Left Pedestal Credenza	H_725L 72" x 24" x 29"	1	125	35.7	184	1210	1228	1246		
Right Pedestal Credenza	H_725R 72" x 24" x 29"	1	125	35.7	184	1210	1228	1246		
Peninsula Desk	HW_799 72" x 36" x 29"	1	125	51.6	155	987	1002	1017		
Bridge	HW_485 48" x 24" x 29"	2	100	4.0	66	484	491	499		
Overhead Storage Unit with Doors	H_737 72" x 16" x 36.5"	2	125	33.6	221	1376	1397	1417		
Open Overhead Storage Unit	HW_317 36" x 16" x 36.5"	1	125	15.3	105	573	582	590		
Group Total:						175.90	915	7700	7816	7931

Reception Station

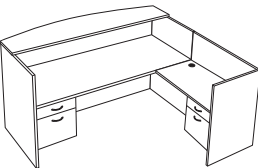

72" x 78" x 42"

Description	Model Number	QT	FT.Class	Cubic FT	Ship Weight	Zone Pricing				
Left Pedestal Reception Desk	H_7230L 72" x 36" x 42"	1	200	64.9	343	1788	1815	1842		
Right Pedestal Reception Return	H_2442R 42" x 24" x 41"	1	110	32.9	195	1193	1211	1229		
Total:						96.80	538	2981	3026	3071

Desks

Double Pedestal Bow Front Desk



- Bow front top
- Box/File pedestals
- Pre-installed black filing hardware
- Letter or legal filing
- Individually locking pedestals

Freight Class: 200

H_720B QS	72" X 36" X 29"	Cubic Ft: 51.6	Ship Weight: 280	1851	1879	1907
	Center Drawer C	177	180	182		
	Keyboard Platform K	203	206	209		

Pulls:	BRUSHED CHROME HW	EBONY HE	BRIGHT BRASS HB	OVAL NICKEL HD	T-BAR NICKEL HV
---------------	--------------------------	-----------------	------------------------	-----------------------	------------------------

QS FINISHES	WC	QS PULLS	W
--------------------	-----------	-----------------	----------

Double Full Pedestal Bow Front Desk



- Bow front top
- File/File left pedestal
- Box/Box/File right pedestal
- Pre-installed black filing hardware
- Letter or legal filing
- Individually locking pedestals

Freight Class: 110

H_720BF2BF	72" X 36" X 29"	Cubic Ft: 51.6	Ship Weight: 330	2353	2388	2424
	Center Drawer C	177	180	182		
	Keyboard Platform K	203	206	209		

Pulls:	BRUSHED CHROME HW	EBONY HE	BRIGHT BRASS HB	OVAL NICKEL HD	T-BAR NICKEL HV
---------------	--------------------------	-----------------	------------------------	-----------------------	------------------------

Double Full Pedestal Bow Front Desk with Aluminum/Frosted Modesty Panel



- Bow front top
- Aluminum frosted modesty panel
- Box/Box/File right pedestal
- File/File left pedestal
- Pre-installed black filing hardware
- Letter or legal filing
- Locking pedestal

Freight Class: 110

H_701BF2BF	72" X 36" X 29"	Cubic Ft: 51.6	Ship Weight: 325	2963	3007	3052
	Center Drawer C	177	180	182		
	Keyboard Platform K	203	206	209		

Pulls:	BRUSHED CHROME HW	EBONY HE	BRIGHT BRASS HB	OVAL NICKEL HD	T-BAR NICKEL HV
---------------	--------------------------	-----------------	------------------------	-----------------------	------------------------



Double Pedestal Desk

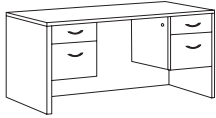

- Box/File pedestals
- Pre-installed black filing hardware
- Letter or legal filing
- Individually locking pedestals

Freight Class: 110

Double Full Pedestal Desk



- File/File left pedestal
- Box/Box/File right pedestal
- Pre-installed black filing hardware
- Letter or legal filing
- Individually locking pedestals

Freight Class: 110

Double Full Pedestal Desk With Aluminum/Frosted Modesty Panel



- File/File left pedestal
- Box/Box/File right pedestal
- Pre-installed black filing hardware
- Letter or legal filing
- Individually locking pedestals
- Aluminum/frosted modesty panel

Freight Class: 110

Left Pedestal Bow Front Desk

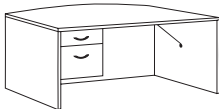

- Bow front top
- Box/File left pedestal
- Pre-installed black filing hardware
- Letter or legal filing
- Side locking

Freight Class: 200

Right Pedestal Bow Front Desk

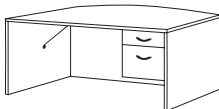

- Bow front top
- Box/File right pedestal
- Pre-installed black filing hardware
- Letter or legal filing
- Side locking

Freight Class: 200

Left Full Pedestal Bow Front Desk

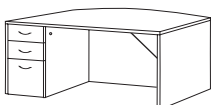

- Bow front top
- Box/Box/File left pedestal
- Pre-installed black filing hardware
- Letter or legal filing
- Side locking

Freight Class: 200

Zone Pricing

				1	2	3	
H_720	QS	72" X 36" X 29"	Cubic Ft: 51.6	Ship Weight: 289	1596	1620	1644
				Center Drawer C	177	180	182
				Keyboard Platform K	203	206	209
H_700		72" X 30" X 29"	Cubic Ft: 44.4	Ship Weight: 259	1426	1447	1469
				Center Drawer C	177	180	182
				Keyboard Platform K	203	206	209
H_660		66" X 30" X 29"	Cubic Ft: 40.2	Ship Weight: 249	1397	1418	1439
				Center Drawer C	177	180	182
				Keyboard Platform K	203	206	209
H_600		60" X 30" X 29"	Cubic Ft: 36.7	Ship Weight: 235	1348	1368	1388
				Center Drawer C	177	180	182
				Keyboard Platform K	203	206	209
Pulls:		BRUSHED CHROME HW	EBONY HE	BRIGHT BRASS HB	OVAL NICKEL HD	T-BAR NICKEL HV	
QS FINISHES		WC	QS PULLS		W		

H_720F2BF		72" X 36" X 29"	Cubic Ft: 51.6	Ship Weight: 330	2050	2081	2112
				Center Drawer C	177	180	182
				Keyboard Platform K	203	206	209
H_700F2BF		72" X 30" X 29"	Cubic Ft: 44.4	Ship Weight: 299	2002	2032	2062
				Center Drawer C	177	180	182
				Keyboard Platform K	203	206	209
H_660F2BF		66" X 30" X 29"	Cubic Ft: 40.2	Ship Weight: 289	1925	1954	1983
				Center Drawer C	177	180	182
				Keyboard Platform K	203	206	209
H_600F2BF		60" X 30" X 29"	Cubic Ft: 36.7	Ship Weight: 280	1866	1894	1922
				Center Drawer C	165	167	170
				Keyboard Platform K	196	199	202
Pulls:		BRUSHED CHROME HW	EBONY HE	BRIGHT BRASS HB	OVAL NICKEL HD	T-BAR NICKEL HV	

H_701F2BF		72" X 36" X 29"	Cubic Ft: 51.6	Ship Weight: 330	2654	2694	2734
				Center Drawer C	177	180	182
				Keyboard Platform K	203	206	209
Pulls:		BRUSHED CHROME HW	EBONY HE	BRIGHT BRASS HB	OVAL NICKEL HD	T-BAR NICKEL HV	

H_721LB		72" X 36" X 29"	Cubic Ft: 51.6	Ship Weight: 250	1624	1648	1673
				Center Drawer C	165	167	170
				Keyboard Platform K	196	199	202
Pulls:		BRUSHED CHROME HW	EBONY HE	BRIGHT BRASS HB	OVAL NICKEL HD	T-BAR NICKEL HV	

H_721RB		72" X 36" X 29"	Cubic Ft: 51.6	Ship Weight: 250	1624	1648	1673
				Center Drawer C	165	167	170
				Keyboard Platform K	196	199	202
Pulls:		BRUSHED CHROME HW	EBONY HE	BRIGHT BRASS HB	OVAL NICKEL HD	T-BAR NICKEL HV	

H_721LB2BF		72" X 36" X 29"	Cubic Ft: 51.6	Ship Weight: 262	1860	1888	1916
				Center Drawer C	165	167	170
				Keyboard Platform K	196	199	202
Pulls:		BRUSHED CHROME HW	EBONY HE	BRIGHT BRASS HB	OVAL NICKEL HD	T-BAR NICKEL HV	

CONTEMPORARY LAMINATE

Right Full Pedestal Bow Front Desk

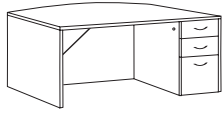

- Bow front top
- Box/Box/File right pedestal
- Pre-installed black filing hardware
- Letter or legal filing
- Side locking

Freight Class: 200

		Zone Pricing		1	2	3
H_721RB2BF	72" X 36" X 29" Cubic Ft: 51.6 Ship Weight: 262	1860	1888	1916		
	Center Drawer C	165	167	170		
	Keyboard Platform K	196	199	202		
Pulls:	BRUSHED CHROME HW EBONY HE BRIGHT BRASS HB OVAL NICKEL HD T-BAR NICKEL HV					

Left Full Pedestal Bow Front Desk With Aluminum/Frosted Modesty Panel

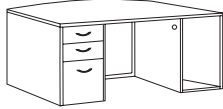

- Aluminum/frosted modesty panel
- Box/Box/File left pedestal
- Open storage right pedestal
- Pre-installed black filing hardware
- Letter or legal filing
- Locking pedestal

Freight Class: 110

H_701LB2BF	72" X 36" X 29" Cubic Ft: 51.6 Ship Weight: 282	2557	2595	2634		
	Center Drawer C	165	167	170		
	Keyboard Platform K	196	199	202		
Pulls:	BRUSHED CHROME HW EBONY HE BRIGHT BRASS HB OVAL NICKEL HD T-BAR NICKEL HV					

Right Full Pedestal Bow Front Desk With Aluminum/Frosted Modesty Panel

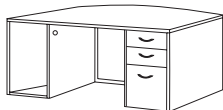

- Aluminum/frosted modesty panel
- Box/Box/File right pedestal
- Open storage left pedestal
- Pre-installed black filing hardware
- Letter or legal filing
- Locking pedestal

Freight Class: 110

H_701RB2BF	72" X 36" X 29" Cubic Ft: 51.6 Ship Weight: 282	2557	2595	2634		
	Center Drawer C	165	167	170		
	Keyboard Platform K	196	199	202		
Pulls:	BRUSHED CHROME HW EBONY HE BRIGHT BRASS HB OVAL NICKEL HD T-BAR NICKEL HV					

Left Pedestal Desk

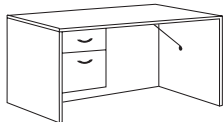

- Box/File left pedestal
- Pre-installed black filing hardware
- Letter or legal filing
- Side locking

H_721L QS	72" X 36" X 29" Cubic Ft: 51.6 Ship Weight: 250	1397	1418	1439		
Freight Class: 200	Center Drawer C	165	167	170		
	Keyboard Platform K	196	199	202		
H_700L	72" X 30" X 29" Cubic Ft: 44.4 Ship Weight: 225	1283	1302	1321		
Freight Class: 200	Center Drawer C	165	167	170		
	Keyboard Platform K	196	199	202		
H_651L QS	66" X 30" X 29" Cubic Ft: 40.6 Ship Weight: 218	1269	1288	1307		
Freight Class: 200	Center Drawer C	165	167	170		
	Keyboard Platform K	196	199	202		
H_641L	60" X 30" X 29" Cubic Ft: 36.7 Ship Weight: 199	1113	1130	1146		
Freight Class: 200	Center Drawer C	165	167	170		
	Keyboard Platform K	196	199	202		
H_431L	48" X 30" X 29" Cubic Ft: 30.1 Ship Weight: 179	1018	1033	1049		
Freight Class: 110	Center Drawer C	165	167	170		
	Keyboard Platform K	196	199	202		
Pulls:	BRUSHED CHROME HW EBONY HE BRIGHT BRASS HB OVAL NICKEL HD T-BAR NICKEL HV					

QS FINISHES WC **QS PULLS W**

Right Pedestal Desk

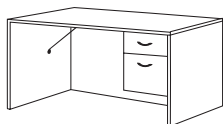

- Box/File right pedestal
- Pre-installed black filing hardware
- Letter or legal filing
- Side locking

H_721R QS	72" X 36" X 29" Cubic Ft: 51.6 Ship Weight: 250	1397	1418	1439		
Freight Class: 200	Center Drawer C	165	167	170		
	Keyboard Platform K	196	199	202		
H_700R	72" X 30" X 29" Cubic Ft: 44.4 Ship Weight: 225	1283	1302	1321		
Freight Class: 200	Center Drawer C	165	167	170		
	Keyboard Platform K	196	199	202		
H_651R QS	66" X 30" X 29" Cubic Ft: 40.6 Ship Weight: 218	1269	1288	1307		
Freight Class: 200	Center Drawer C	165	167	170		
	Keyboard Platform K	196	199	202		
H_641R	60" X 30" X 29" Cubic Ft: 36.7 Ship Weight: 199	1113	1130	1146		
Freight Class: 200	Center Drawer C	165	167	170		
	Keyboard Platform K	196	199	202		
H_431R	48" X 30" X 29" Cubic Ft: 30.1 Ship Weight: 179	1018	1033	1049		
Freight Class: 110	Center Drawer C	165	167	170		
	Keyboard Platform K	196	199	202		
Pulls:	BRUSHED CHROME HW EBONY HE BRIGHT BRASS HB OVAL NICKEL HD T-BAR NICKEL HV					

QS FINISHES WC **QS PULLS W**

CONTEMPORARY LAMINATE



Left Full Pedestal Desk

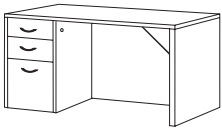

- Box/Box/File left pedestal
- Pre-installed black filing hardware
- Letter or legal filing
- Side locking pedestal

				Zone Pricing	1	2	3
H_721L2BF	72" X 36" X 29"	Cubic Ft: 51.6	Ship Weight: 275	1559	1582	1606	
Freight Class: 200				Center Drawer C	165	167	170
				Keyboard Platform K	196	199	202
H_700L2BF	72" X 30" X 29"	Cubic Ft: 44.4	Ship Weight: 250	1509	1532	1554	
Freight Class: 110				Center Drawer C	165	167	170
				Keyboard Platform K	196	199	202
H_651L2BF	66" X 30" X 29"	Cubic Ft: 40.6	Ship Weight: 243	1457	1479	1501	
Freight Class: 110				Center Drawer C	165	167	170
				Keyboard Platform K	196	199	202
H_641L2BF	60" X 30" X 29"	Cubic Ft: 36.7	Ship Weight: 224	1245	1264	1282	
Freight Class: 110				Center Drawer C	165	167	170
				Keyboard Platform K	196	199	202
H_431L2BF	48" X 30" X 29"	Cubic Ft: 30.1	Ship Weight: 192	1136	1153	1170	
Freight Class: 110				Center Drawer C	165	167	170
				Keyboard Platform K	196	199	202
Pulls:	BRUSHED CHROME HW	EBONY HE	BRIGHT BRASS HB	OVAL NICKEL HD	T-BAR NICKEL HV		

Right Full Pedestal Desk

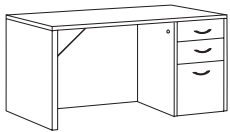

- Same description as above except:
- Box/Box/File right pedestal

H_721R2BF	72" X 36" X 29"	Cubic Ft: 51.6	Ship Weight: 275	1559	1582	1606	
Freight Class: 200				Center Drawer C	165	167	170
				Keyboard Platform K	196	199	202
H_700R2BF	72" X 30" X 29"	Cubic Ft: 44.4	Ship Weight: 250	1509	1532	1554	
Freight Class: 110				Center Drawer C	165	167	170
				Keyboard Platform K	196	199	202
H_651R2BF	66" X 30" X 29"	Cubic Ft: 40.2	Ship Weight: 243	1457	1479	1501	
Freight Class: 110				Center Drawer C	165	167	170
				Keyboard Platform K	196	199	202
H_641R2BF	60" X 30" X 29"	Cubic Ft: 36.7	Ship Weight: 224	1245	1264	1282	
Freight Class: 110				Center Drawer C	165	167	170
				Keyboard Platform K	196	199	202
H_431R2BF	48" X 30" X 29"	Cubic Ft: 30.1	Ship Weight: 192	1136	1153	1170	
Freight Class: 110				Center Drawer C	165	167	170
				Keyboard Platform K	196	199	202
Pulls:	BRUSHED CHROME HW	EBONY HE	BRIGHT BRASS HB	OVAL NICKEL HD	T-BAR NICKEL HV		

Left Full Pedestal Desk With Aluminum/Frosted Modesty Panel

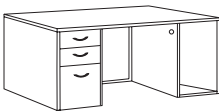

- Aluminum/frosted modesty panel
- Box/Box/File left pedestal
- Open storage right pedestal
- Pre-installed black filing hardware
- Letter or legal filing
- Locking pedestal

Freight Class: 110

H_701L2BF	72" X 36" X 29"	Cubic Ft: 51.6	Ship Weight: 295	2430	2466	2503	
				Center Drawer C	165	167	170
				Keyboard Platform K	196	199	202
Pulls:	BRUSHED CHROME HW	EBONY HE	BRIGHT BRASS HB	OVAL NICKEL HD	T-BAR NICKEL HV		



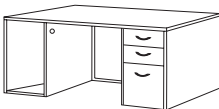



Right Full Pedestal Desk With Aluminum/Frosted Modesty Panel

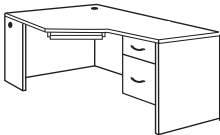

- Same description as above except:
- Box/Box/File right pedestal
- Open storage left pedestal

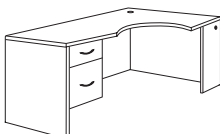
Freight Class: 110

H_701R2BF	72" X 36" X 29"	Cubic Ft: 51.6	Ship Weight: 295	2430	2466	2503	
				Center Drawer C	165	167	170
				Keyboard Platform K	196	199	202
Pulls:	BRUSHED CHROME HW	EBONY HE	BRIGHT BRASS HB	OVAL NICKEL HD	T-BAR NICKEL HV		

Corner Desks		Zone Pricing	1	2	3
 <ul style="list-style-type: none"> • Easy computer pullup • Keyboard platform standard • Locking Box/File left pedestal • Pre-installed, black filing hardware • Legal or letter filing • One grommet in top, one in modesty panel and one in half leg 	H_451L	72" X 36/24" X 29" Cubic Ft: 51.6 Ship Weight: 269	1942	1971	2000
	Pulls:	BRUSHED CHROME HW EBONY HE BRIGHT BRASS HB OVAL NICKEL HD T-BAR NICKEL HV			
	Freight Class: 200				
 <ul style="list-style-type: none"> • Same description as above except: • Locking Box/File right pedestal 	H_451R	72" X 36/24" X 29" Cubic Ft: 51.6 Ship Weight: 269	1942	1971	2000
	Pulls:	BRUSHED CHROME HW EBONY HE BRIGHT BRASS HB OVAL NICKEL HD T-BAR NICKEL HV			
	Freight Class: 200				
 <ul style="list-style-type: none"> • Easy computer pullup • Keyboard platform standard • Locking Box/Box/File left pedestal • Pre-installed, black filing hardware • Legal or letter filing • One grommet in top, one in modesty panel and one in half leg 	H_451L2BF	72" X 36/24" X 29" Cubic Ft: 51.6 Ship Weight: 294	2132	2164	2196
	Pulls:	BRUSHED CHROME HW EBONY HE BRIGHT BRASS HB OVAL NICKEL HD T-BAR NICKEL HV			
	Freight Class: 110				
 <ul style="list-style-type: none"> • Same description as above except: • Locking Box/Box/File right pedestal 	H_451R2BF	72" X 36/24" X 29" Cubic Ft: 51.6 Ship Weight: 294	2132	2164	2196
	Pulls:	BRUSHED CHROME HW EBONY HE BRIGHT BRASS HB OVAL NICKEL HD T-BAR NICKEL HV			
	Freight Class: 110				
 <ul style="list-style-type: none"> • Use with right asymmetrical bridge or shell with 19" connection • Full-access worksurface • Locking Box/File left pedestal • Pre-installed, black filing hardware • Legal or letter filing • One grommet in top and one in half leg 	H_462L	72" X 42/30" X 29" Cubic Ft: 58.9 Ship Weight: 299	1942	1971	2000
	Pulls:	BRUSHED CHROME HW EBONY HE BRIGHT BRASS HB OVAL NICKEL HD T-BAR NICKEL HV			
	Freight Class: 200				
 <ul style="list-style-type: none"> • Same description as above except: • Locking Box/File right pedestal 	H_462R	72" X 42/30" X 29" Cubic Ft: 58.9 Ship Weight: 299	1942	1971	2000
	Pulls:	BRUSHED CHROME HW EBONY HE BRIGHT BRASS HB OVAL NICKEL HD T-BAR NICKEL HV			
	Freight Class: 200				
 <ul style="list-style-type: none"> • Use with right asymmetrical bridge or shell with 19" connection • Full-access worksurface • Locking Box/Box/File left pedestal • Pre-installed, black filing hardware • Legal or letter filing • One grommet in top and one in half leg 	H_462L2BF	72" X 42/30" X 29" Cubic Ft: 58.9 Ship Weight: 324	2132	2164	2196
	Pulls:	BRUSHED CHROME HW EBONY HE BRIGHT BRASS HB OVAL NICKEL HD T-BAR NICKEL HV			
	Freight Class: 110				
 <ul style="list-style-type: none"> • Same description as above except: • Locking Box/Box/File right pedestal 	H_462R2BF	72" X 42/30" X 29" Cubic Ft: 58.9 Ship Weight: 324	2132	2164	2196
	Pulls:	BRUSHED CHROME HW EBONY HE BRIGHT BRASS HB OVAL NICKEL HD T-BAR NICKEL HV			
	Freight Class: 110				

CONTEMPORARY LAMINATE



Peninsulas & P-Top Desks

Zone Pricing	1	2	3
--------------	---	---	---

Peninsula Desk

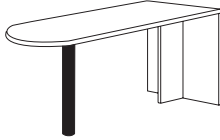

- Use with returns, bridges or rectangular shells
- Steel 4" diameter black cylinder base with leveling glide
- End support panel

Freight Class: 125

HW_799	QS	72" X 36" X 29"	Cubic Ft: 51.6	Ship Weight: 155	987	1002	1017
---------------	-----------	-----------------	----------------	------------------	------------	-------------	-------------

QS FINISHES WC

Peninsula Desk with Modesty Panel

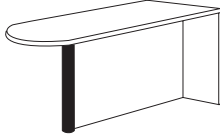

- Use with returns, bridges or rectangular shells
- Steel 4" diameter black cylinder base with leveling glide
- Full modesty panel
- End support panel

Freight Class: 125

HW_798		72" X 36" X 29"	Cubic Ft: 51.6	Ship Weight: 185	1027	1042	1058
---------------	--	-----------------	----------------	------------------	-------------	-------------	-------------

Peninsula Top and Column

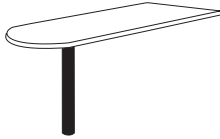

- Connect unsupported end to rectangular shell or credenza
- Steel 4" diameter black cylinder base with leveling glide
- Assembly required

Freight Class: 85

HW_797		72" X 36" X 29"	Cubic Ft: 51.6	Ship Weight: 115	808	820	832
---------------	--	-----------------	----------------	------------------	------------	------------	------------

Left P-Shape Desk



- Use with bridges, right returns or rectangular shells
- Allows mini-conferencing within office
- Steel 4" diameter black cylinder base with leveling glide
- End support panel

Freight Class: 125

HW_899L		72" X 42/30" X 29"	Cubic Ft: 58.9	Ship Weight: 160	1133	1150	1167
----------------	--	--------------------	----------------	------------------	-------------	-------------	-------------

Right P-Shape Desk

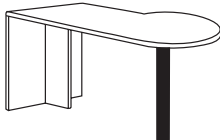

- Same descriptions as above except:
- Use with bridges, left returns or rectangular shells

Freight Class: 125

HW_899R		72" X 42/30" X 29"	Cubic Ft: 58.9	Ship Weight: 160	1133	1150	1167
----------------	--	--------------------	----------------	------------------	-------------	-------------	-------------

Left P-Shape Desk with Modesty Panel

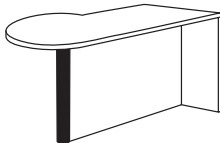

- Use with bridges, right returns or rectangular shells
- Allows mini-conferencing within office
- Steel 4" diameter black cylinder base with leveling glide
- Full modesty panel
- End support panel

Freight Class: 250

HW_898L		72" X 42/30" X 29"	Cubic Ft: 58.9	Ship Weight: 190	1200	1218	1236
----------------	--	--------------------	----------------	------------------	-------------	-------------	-------------

Right P-Shape Desk with Modesty Panel

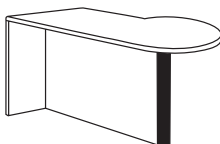

- Same description as above except:
- Use with bridges, left returns or rectangular shells

Freight Class: 250

HW_898R		72" X 42/30" X 29"	Cubic Ft: 58.9	Ship Weight: 190	1200	1218	1236
----------------	--	--------------------	----------------	------------------	-------------	-------------	-------------

Zone Pricing	1	2	3
--------------	---	---	---

Left P-Shape Top and Column

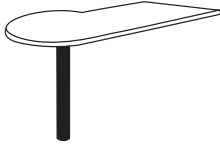

- Connect unsupported end to rectangular shell or right credenza
- Allows mini-conferencing within office
- Steel 4" diameter black cylinder base with leveling glide
- Assembly required

Freight Class: 125

HW_897L	72" X 42/30" X 29" Cubic Ft: 18.2 Ship Weight: 125	990	1005	1020
----------------	--	------------	-------------	-------------

Right P-Shape Top and Column

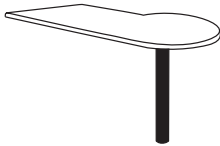

- Same description as above except:
- Connect unsupported end to rectangular shell or left credenza

Freight Class: 125

HW_897R	72" X 42/30" X 29" Cubic Ft: 18.2 Ship Weight: 125	990	1005	1020
----------------	--	------------	-------------	-------------

Credenzas

MultiFile Credenza

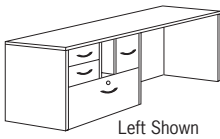

- One lateral file drawer with lock and extra thick drawer bottom
- One file drawer
- Pre-installed, black filing hardware
- Legal or letter filing
- Two box drawers
- HOT PROJECTS ACCESS SLOT
- H_735L - Left pedestal
- H_735R - Right pedestal

Freight Class: 125

H_735L	72" X 24" X 29" Cubic Ft: 35.7 Ship Weight: 261	1632	1656	1681
---------------	---	-------------	-------------	-------------

H_735R	72" X 24" X 29" Cubic Ft: 35.7 Ship Weight: 261	1632	1656	1681
---------------	---	-------------	-------------	-------------

Pulls:	BRUSHED CHROME HW	EBONY HE	BRIGHT BRASS HB	OVAL NICKEL HD	T-BAR NICKEL HV
---------------	--------------------------	-----------------	------------------------	-----------------------	------------------------

Computer Credenza

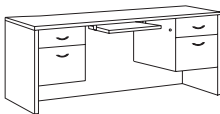

- Box/File pedestals
- Pre-installed, black filing hardware
- Legal or letter filing
- Keyboard platform standard
- Grommet in modesty panel
- Individually locking pedestals

Freight Class: 110

H_744	QS 72" X 24" X 29" Cubic Ft: 35.7 Ship Weight: 275	1450	1472	1494
--------------	---	-------------	-------------	-------------

H_644	66" X 24" X 29" Cubic Ft: 32.8 Ship Weight: 250	1401	1422	1443
--------------	---	-------------	-------------	-------------

Pulls:	BRUSHED CHROME HW	EBONY HE	BRIGHT BRASS HB	OVAL NICKEL HD	T-BAR NICKEL HV
---------------	--------------------------	-----------------	------------------------	-----------------------	------------------------

QS FINISHES	WC	QS PULLS	W
--------------------	-----------	-----------------	----------

Full Pedestal Computer Credenza

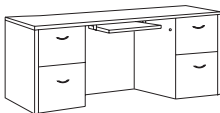

- Same description as above except:
- File/File pedestals

Freight Class: 110

H_744F	72" X 24" X 29" Cubic Ft: 35.7 Ship Weight: 305	1746	1772	1798
---------------	---	-------------	-------------	-------------

H_644F	66" X 24" X 29" Cubic Ft: 32.8 Ship Weight: 280	1692	1717	1743
---------------	---	-------------	-------------	-------------

Pulls:	BRUSHED CHROME HW	EBONY HE	BRIGHT BRASS HB	OVAL NICKEL HD	T-BAR NICKEL HV
---------------	--------------------------	-----------------	------------------------	-----------------------	------------------------

Double Lateral File Credenza



- Four full-size lateral file drawers
- Pre-installed, black filing hardware
- Legal or letter filing
- Front locking

Freight Class: 125

H_733	72.5" X 24" X 29" Cubic Ft: 35.7 Ship Weight: 299	2086	2117	2149
--------------	---	-------------	-------------	-------------

Pulls:	BRUSHED CHROME HW	EBONY HE	BRIGHT BRASS HB	OVAL NICKEL HD	T-BAR NICKEL HV
---------------	--------------------------	-----------------	------------------------	-----------------------	------------------------

EXTRA THICK BOTTOM	\$320 H
---------------------------	----------------

Left Lateral File/Bookcase Credenza



- Two full-size lateral file drawers left
- Front locking lateral file
- Pre-installed, black filing hardware
- Legal or letter filing
- Bookcase with doors and adjustable shelf right

Freight Class: 125

H_733L	72.5" X 24" X 29" Cubic Ft: 35.7 Ship Weight: 299	1875	1903	1931
---------------	---	-------------	-------------	-------------

Pulls:	BRUSHED CHROME HW	EBONY HE	BRIGHT BRASS HB	OVAL NICKEL HD	T-BAR NICKEL HV
---------------	--------------------------	-----------------	------------------------	-----------------------	------------------------

EXTRA THICK BOTTOM	\$160 H
---------------------------	----------------

CONTEMPORARY LAMINATE



Zone Pricing	1	2	3
--------------	---	---	---

Right Lateral File/Bookcase Credenza



- Same description as above except:
- Lateral file on right
- Bookcase on left

Freight Class: 125

H_ BK733R	72.5" X 24" X 29"	Cubic Ft: 35.7	Ship Weight: 306	1875	1903	1931
Pulls:	BRUSHED CHROME HW	EBONY HE	BRIGHT BRASS HB	OVAL NICKEL HD	T-BAR NICKEL HV	
				EXTRA THICK BOTTOM		\$160 H

Left Pedestal Credenza



- Box/File left pedestal
- Pre-installed, black filing hardware
- Legal or letter filing
- Side locking
- One wire management grommet in modesty panel
- Use 19" deep bridge with H_615L credenza to allow more kneespace

Freight Class: 125

H_ 725L QS	72" X 24" X 29"	Cubic Ft: 35.7	Ship Weight: 184	1210	1228	1246
	Center Drawer C			165	167	170
	Keyboard Platform K			196	199	202
H_ 625L	66" X 24" X 29"	Cubic Ft: 32	Ship Weight: 174	1188	1206	1224
	Center Drawer C			165	167	170
	Keyboard Platform K			196	199	202
H_ 615L	60" X 24" X 29"	Cubic Ft: 30.5	Ship Weight: 164	1149	1166	1183
	Center Drawer C			165	167	170
	Keyboard Platform K			196	199	202
Pulls:	BRUSHED CHROME HW	EBONY HE	BRIGHT BRASS HB	OVAL NICKEL HD	T-BAR NICKEL HV	
	QS FINISHES WC		QS PULLS W			

Right Pedestal Credenza

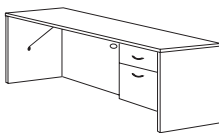

- Same description as above except:
- Box/File right pedestal

Freight Class: 125

H_ 725R QS	72" X 24" X 29"	Cubic Ft: 35.7	Ship Weight: 184	1210	1228	1246
	Center Drawer C			165	167	170
	Keyboard Platform K			196	199	202
H_ 625R	66" X 24" X 29"	Cubic Ft: 32	Ship Weight: 174	1188	1206	1224
	Center Drawer C			165	167	170
	Keyboard Platform K			196	199	202
H_ 615R	60" X 24" X 29"	Cubic Ft: 30.5	Ship Weight: 164	1149	1166	1183
	Center Drawer C			165	167	170
	Keyboard Platform K			196	199	202
Pulls:	BRUSHED CHROME HW	EBONY HE	BRIGHT BRASS HB	OVAL NICKEL HD	T-BAR NICKEL HV	
	QS FINISHES WC		QS PULLS W			

Left Full Pedestal Credenza

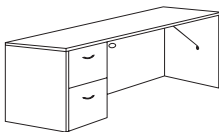

- File/File left pedestal
- Pre-installed, black filing hardware
- Legal or letter filing
- Side locking
- One wire management grommet in modesty panel
- Use 19" deep bridge with H_615LF credenza to allow more kneespace

Freight Class: 125

H_ 725LF	72" X 24" X 29"	Cubic Ft: 35.7	Ship Weight: 199	1449	1471	1492
	Center Drawer C			165	167	170
	Keyboard Platform K			196	199	202
H_ 625LF	66" X 24" X 29"	Cubic Ft: 32	Ship Weight: 189	1431	1452	1474
	Center Drawer C			165	167	170
	Keyboard Platform K			196	199	202
H_ 615LF	60" X 24" X 29"	Cubic Ft: 30.5	Ship Weight: 179	1413	1434	1455
	Center Drawer C			165	167	170
	Keyboard Platform K			196	199	202
Pulls:	BRUSHED CHROME HW	EBONY HE	BRIGHT BRASS HB	OVAL NICKEL HD	T-BAR NICKEL HV	

Right Full Pedestal Credenza



- Same description as above except:
- File/File right pedestal

Freight Class: 125

H_ 725RF	72" X 24" X 29"	Cubic Ft: 35.7	Ship Weight: 199	1449	1471	1492
	Center Drawer C			165	167	170
	Keyboard Platform K			196	199	202
H_ 625RF	66" X 24" X 29"	Cubic Ft: 32	Ship Weight: 189	1431	1452	1474
	Center Drawer C			165	167	170
	Keyboard Platform K			196	199	202
H_ 615RF	60" X 24" X 29"	Cubic Ft: 30.5	Ship Weight: 179	1413	1434	1455
	Center Drawer C			165	167	170
	Keyboard Platform K			196	199	202
Pulls:	BRUSHED CHROME HW	EBONY HE	BRIGHT BRASS HB	OVAL NICKEL HD	T-BAR NICKEL HV	

Zone Pricing

1

2

3

Left Lateral File Credenza



- Two lateral file drawers on left
- Pre-installed, black filing hardware
- Legal or letter filing
- Front locking

Freight Class: 125

H_733L	72" X 24" X 29"	Cubic Ft: 35.7	Ship Weight: 229	1539	1562	1585
H_633L	66" X 24" X 29"	Cubic Ft: 32	Ship Weight: 219	1486	1508	1531

Pulls:	BRUSHED CHROME HW	EBONY HE	BRIGHT BRASS HB	OVAL NICKEL HD	T-BAR NICKEL HV
---------------	--------------------------	-----------------	------------------------	-----------------------	------------------------

EXTRA THICK BOTTOM \$160 **H**

Right Lateral File Credenza

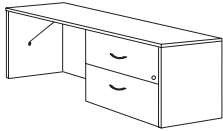

- Same description as above except:
- Two lateral file drawers on right

Freight Class: 125

H_733R	72" X 24" X 29"	Cubic Ft: 35.7	Ship Weight: 229	1539	1562	1585
H_633R	66" X 24" X 29"	Cubic Ft: 32	Ship Weight: 219	1486	1508	1531

Pulls:	BRUSHED CHROME HW	EBONY HE	BRIGHT BRASS HB	OVAL NICKEL HD	T-BAR NICKEL HV
---------------	--------------------------	-----------------	------------------------	-----------------------	------------------------

EXTRA THICK BOTTOM \$160 **H**

Left Bookcase Credenza

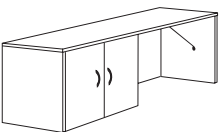

- Bookcase compartment with one adjustable shelf on left
- Doors conceal contents from view
- Inside dimensions 34" x 21" x 24"

Freight Class: 125

H_734L	72" X 24" X 29"	Cubic Ft: 35.7	Ship Weight: 225	1539	1562	1585
H_634L	66" X 24" X 29"	Cubic Ft: 32	Ship Weight: 219	1486	1508	1531

Pulls:	BRUSHED CHROME HW	EBONY HE	BRIGHT BRASS HB	OVAL NICKEL HD	T-BAR NICKEL HV
---------------	--------------------------	-----------------	------------------------	-----------------------	------------------------

Right Bookcase Credenza

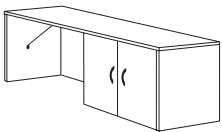

- Same description as above except:
- Bookcase compartment on right

Freight Class: 125

H_734R	72" X 24" X 29"	Cubic Ft: 35.7	Ship Weight: 225	1539	1562	1585
H_634R	66" X 24" X 29"	Cubic Ft: 32	Ship Weight: 219	1486	1508	1531

Pulls:	BRUSHED CHROME HW	EBONY HE	BRIGHT BRASS HB	OVAL NICKEL HD	T-BAR NICKEL HV
---------------	--------------------------	-----------------	------------------------	-----------------------	------------------------

Double Bookcase Credenza

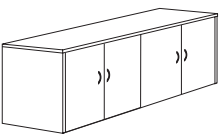

- Two bookcase compartments, each with adjustable shelf
- Doors conceal contents from view
- Bookcase compartment dimensions: 34" x 21" x 25"

Freight Class: 125

H_734	72.5" X 24" X 29"	Cubic Ft: 35.7	Ship Weight: 313	1693	1718	1744
--------------	-------------------	----------------	------------------	-------------	-------------	-------------

Pulls:	BRUSHED CHROME HW	EBONY HE	BRIGHT BRASS HB	OVAL NICKEL HD	T-BAR NICKEL HV
---------------	--------------------------	-----------------	------------------------	-----------------------	------------------------

Returns & Bridges

Left MultiFile Return

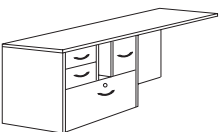

- MultiFile on left with one locking lateral file drawer includes extra thick drawer bottom
- One file and two box drawers
- Pre-installed, black filing hardware
- Legal or letter filing
- HOT PROJECTS ACCESS SLOT
- Connects with single pedestal desks or credenzas

Freight Class: 110

H_735LRT	72" X 24" X 29"	Cubic Ft: 35.7	Ship Weight: 250	1632	1656	1681
-----------------	-----------------	----------------	------------------	-------------	-------------	-------------

Keyboard Platform K	196	199	202
----------------------------	-----	-----	-----

Pulls:	BRUSHED CHROME HW	EBONY HE	BRIGHT BRASS HB	OVAL NICKEL HD	T-BAR NICKEL HV
---------------	--------------------------	-----------------	------------------------	-----------------------	------------------------



Zone Pricing	1	2	3
--------------	---	---	---

Right MultiFile Return

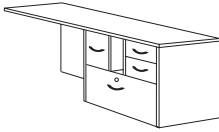

- Same description as above except:
- MultiFile on right

Freight Class: 110

H_ _735RRT	72" X 24" X 29"	Cubic Ft: 35.7	Ship Weight: 250	1632	1656	1681	
				Keyboard Platform K	196	199	202

Pulls:	BRUSHED CHROME HW	EBONY HE	BRIGHT BRASS HB	OVAL NICKEL HD	T-BAR NICKEL HV
---------------	--------------------------	-----------------	------------------------	-----------------------	------------------------

Left Lateral File Return



- Two lateral file drawers
- Pre-installed filing hardware
- Legal or letter filing
- Connects with single pedestal desk or credenza

Freight Class: 110

H_ _733LRT	72" X 24" X 29"	Cubic Ft: 35.7	Ship Weight: 220	1466	1488	1510	
				Keyboard Platform K	196	199	202

Pulls:	BRUSHED CHROME HW	EBONY HE	BRIGHT BRASS HB	OVAL NICKEL HD	T-BAR NICKEL HV
---------------	--------------------------	-----------------	------------------------	-----------------------	------------------------

EXTRA THICK BOTTOM	\$160 H
---------------------------	---------

Right Lateral File Return



- Two lateral file drawers
- Pre-installed filing hardware
- Legal or letter filing
- Connects with single pedestal desk or credenza

Freight Class: 110

H_ _733RRT	72" X 24" X 29"	Cubic Ft: 35.7	Ship Weight: 220	1466	1488	1510	
				Keyboard Platform K	196	199	202

Pulls:	BRUSHED CHROME HW	EBONY HE	BRIGHT BRASS HB	OVAL NICKEL HD	T-BAR NICKEL HV
---------------	--------------------------	-----------------	------------------------	-----------------------	------------------------

EXTRA THICK BOTTOM	\$160 H
---------------------------	---------

Left Pedestal Desk Height Return

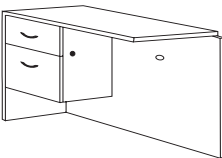

- Box/File left pedestal
- Pre-installed, black filing hardware
- Legal or letter filing
- Wire management grommet in modesty panel
- Side locking

Freight Class: 110

H_ _762L	60" X 24" X 29"	Cubic Ft: 32	Ship Weight: 161	1075	1091	1107
H_ _722L QS	48" X 24" X 29"	Cubic Ft: 24.3	Ship Weight: 149	974	989	1003

				Keyboard Platform K	196	199	202
--	--	--	--	----------------------------	-----	-----	-----

H_ _622L	42" X 24" X 29"	Cubic Ft: 21.5	Ship Weight: 140	950	964	979	
				Keyboard Platform K	196	199	202

H_ _452L QS	36" X 24" X 29"	Cubic Ft: 21.5	Ship Weight: 132	947	961	975
--------------------	-----------------	----------------	------------------	------------	------------	------------

Pulls:	BRUSHED CHROME HW	EBONY HE	BRIGHT BRASS HB	OVAL NICKEL HD	T-BAR NICKEL HV
---------------	--------------------------	-----------------	------------------------	-----------------------	------------------------

QS FINISHES	WC	QS PULLS	W
--------------------	-----------	-----------------	----------

Right Pedestal Desk Height Return

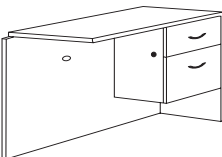

- Same description as above except:
- Box/File right pedestal

Freight Class: 110

H_ _762R	60" X 24" X 29"	Cubic Ft: 32	Ship Weight: 161	1075	1091	1107
H_ _722R QS	48" X 24" X 29"	Cubic Ft: 24.3	Ship Weight: 149	974	989	1003

				Keyboard Platform K	196	199	202
--	--	--	--	----------------------------	-----	-----	-----

H_ _622R	42" X 24" X 29"	Cubic Ft: 21.5	Ship Weight: 140	950	964	979	
				Keyboard Platform K	196	199	202

H_ _452R QS	36" X 24" X 29"	Cubic Ft: 21.5	Ship Weight: 132	947	961	975
--------------------	-----------------	----------------	------------------	------------	------------	------------

Pulls:	BRUSHED CHROME HW	EBONY HE	BRIGHT BRASS HB	OVAL NICKEL HD	T-BAR NICKEL HV
---------------	--------------------------	-----------------	------------------------	-----------------------	------------------------

QS FINISHES	WC	QS PULLS	W
--------------------	-----------	-----------------	----------

Left Full Pedestal Desk Height Return

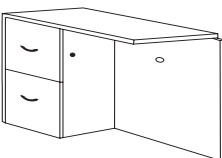

- File/File left pedestal
- Pre-installed, black filing hardware
- Legal or letter filing
- Wire management grommet in modesty panel
- Side locking

Freight Class: 110

H_ _762LF	60" X 24" X 29"	Cubic Ft: 22	Ship Weight: 179	1289	1308	1328	
				Keyboard Platform K	196	199	202

H_ _722LF	48" X 24" X 29"	Cubic Ft: 24.3	Ship Weight: 163	1193	1211	1229	
				Keyboard Platform K	196	199	202

H_ _622LF	42" X 24" X 29"	Cubic Ft: 21.5	Ship Weight: 156	1177	1195	1212	
				Keyboard Platform K	196	199	202

H_ _452LF	36" X 24" X 29"	Cubic Ft: 21.5	Ship Weight: 148	1154	1171	1189
------------------	-----------------	----------------	------------------	-------------	-------------	-------------

Pulls:	BRUSHED CHROME HW	EBONY HE	BRIGHT BRASS HB	OVAL NICKEL HD	T-BAR NICKEL HV
---------------	--------------------------	-----------------	------------------------	-----------------------	------------------------

CONTEMPORARY LAMINATE

Zone Pricing

1

2

3

Right Full Pedestal Desk Height Return

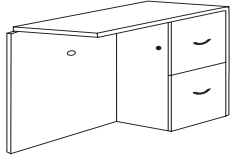

- Same description as above except:
- File/File right pedestal

Freight Class: 110

					1	2	3
H_762RF	60" X 24" X 29"	Cubic Ft: 32	Ship Weight: 179		1289	1308	1328
				Keyboard Platform K	196	199	202
H_722RF	48" X 24" X 29"	Cubic Ft: 24.3	Ship Weight: 163		1193	1211	1229
				Keyboard Platform K	196	199	202
H_622RF	42" X 24" X 29"	Cubic Ft: 21.5	Ship Weight: 156		1177	1195	1212
				Keyboard Platform K	196	199	202
H_452RF	36" X 24" X 29"	Cubic Ft: 21.5	Ship Weight: 148		1154	1171	1189
Pulls:	BRUSHED CHROME HW	EBONY HE	BRIGHT BRASS HB	OVAL NICKEL HD	T-BAR NICKEL HV		

Desk Height Bridge



- Two wire management grommets in modesty panel
- Requires assembly of top to modesty panel
- Use HW_384 with 60" desks to allow more kneespace

Freight Class: 100

HW_485	QS	48" X 24" X 29"	Cubic Ft: 4	Ship Weight: 66	484	491	499
HW_484		42" X 24" X 29"	Cubic Ft: 4	Ship Weight: 58	475	482	489
HW_384		42" X 19" X 29"	Cubic Ft: 4	Ship Weight: 48	480	487	494
	QS FINISHES	WC					

Left Asymmetrical Bridge

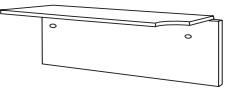

- Connects at both ends; not freestanding
- Radius 19" deep right end connects with curved corner desk or 36" corner module
- Two grommets in modesty panel
- Requires assembly

Freight Class: 100

HW_496L		48" X 24" X 29"	Cubic Ft: 4	Ship Weight: 66	554	562	571
HW_495L		42" X 24" X 29"	Cubic Ft: 4	Ship Weight: 56	537	545	553

Right Asymmetrical Bridge



- Connects at both ends; not freestanding
- Radius 19" deep left end connects with curved corner desk or 36" corner module
- Two grommets in modesty panel
- Requires assembly

Freight Class: 100

HW_496R		48" X 24" X 29"	Cubic Ft: 4	Ship Weight: 66	554	562	571
HW_495R		42" X 24" X 29"	Cubic Ft: 4	Ship Weight: 56	537	545	553

Corner Units

Corner Module

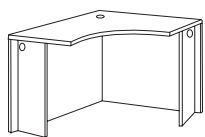

- Curved surface for easy pullup and full access to work area
- Freestanding with two half-legs
- Use 42" x 42" module with 30" deep asymmetrical shells (24" hookup) or 24" deep rectangular shells
- Use 36" x 36" module with 24" deep asymmetrical shells (19" hookup)
- One grommet in top, two in modesty and one in each support leg

Freight Class: 200

HW_449		42" X 42" X 29"	Cubic Ft: 34.3	Ship Weight: 152	846	859	871
HW_448		36" X 36" X 29"	Cubic Ft: 27.2	Ship Weight: 122	746	757	768

Corner Module with Open Modesty Panel

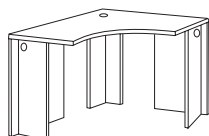

- Curved surface for easy pullup and full access to work area
- Freestanding with two half-legs
- Use 42" x 42" module with 30" deep asymmetrical shells (24" hookup) or 24" deep rectangular shells
- Use 36" x 36" module with 24" deep asymmetrical shells (19" hookup)
- One grommet in top and one in each half leg

Freight Class: 200

HW_4490		42" X 42" X 29"	Cubic Ft: 34.3	Ship Weight: 137	796	808	820
HW_4480		36" X 36" X 29"	Cubic Ft: 27.2	Ship Weight: 107	700	711	721



Zone Pricing	1	2	3
--------------	---	---	---

Corner Module with Straight Front

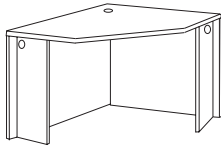

- Freestanding with two half legs
- Straight surface across front
- Easy computer pull up
- One grommet in top, two in modesty panel and one in each half leg
- 24" hookups

Freight Class: 200

HW_449S	42" X 42" X 29"	Cubic Ft: 34.3	Ship Weight: 153	846	859	871
----------------	-----------------	----------------	------------------	------------	------------	------------

Left Dual Depth Corner Module

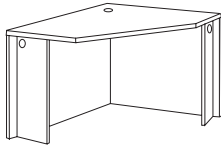

- Attach 30" deep shell/return on left
- Attach 24" deep shell/return on right
- Two half legs
- One grommet in top, two in modesty and one in each support leg

Freight Class: 200

HW_44930L	42" X 42" X 29"	Cubic Ft: 34.3	Ship Weight: 162	773	785	796
------------------	-----------------	----------------	------------------	------------	------------	------------

Right Dual Depth Corner Module

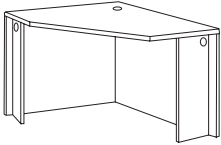

- Attach 30" deep shell/return on right
- Attach 24" deep shell/return on left
- Two half legs
- One grommet in top, two in modesty and one in each support leg

Freight Class: 200

HW_44930R	42" X 42" X 29"	Cubic Ft: 34.3	Ship Weight: 162	773	785	796
------------------	-----------------	----------------	------------------	------------	------------	------------

Left Dual Depth Corner Module, Open Modesty Panel

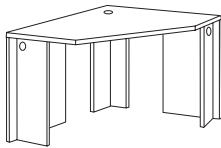

- Attach 30" deep shell/return on left
- Attach 24" deep shell/return on right
- Freestanding with open modesty for easy access to electrical outlets
- One grommet in top, two in corner support and one in each half leg

Freight Class: 200

HW_44930LO	42" X 42" X 29"	Cubic Ft: 38	Ship Weight: 152	742	753	764
-------------------	-----------------	--------------	------------------	------------	------------	------------

Right Dual Depth Corner Module, Open Modesty Panel

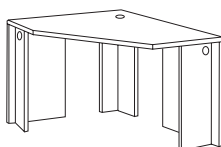

- Attach 30" deep shell/return on right
- Attach 24" deep shell/return on left
- Freestanding with open modesty for easy access to electrical outlets
- One grommet in top, two in corner support and one in each half leg

Freight Class: 200

HW_44930RO	42" X 42" X 29"	Cubic Ft: 37.96	Ship Weight: 152	742	753	764
-------------------	-----------------	-----------------	------------------	------------	------------	------------

Rectangular Shells, 30" Deep

Zone Pricing	1	2	3
--------------	---	---	---

Freestanding Rectangular Shell

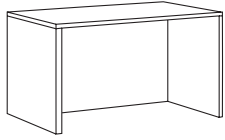

- Freestanding
- Two full legs
- Utility and mobile pedestals available

HW_RS3072	72" X 30" X 29"	Cubic Ft: 44.4	Ship Weight: 200	761	772	784
Freight Class: 200						
HW_RS3066	66" X 30" X 29"	Cubic Ft: 40.2	Ship Weight: 192	737	748	759
Freight Class: 200						
HW_RS3060	60" X 30" X 29"	Cubic Ft: 36.7	Ship Weight: 184	703	714	724
Freight Class: 200						
HW_RS3048	48" X 30" X 29"	Cubic Ft: 30.1	Ship Weight: 179	649	659	668
Freight Class: 110						
HW_RS3042	42" X 30" X 29"	Cubic Ft: 30.1	Ship Weight: 171	608	617	626
Freight Class: 110						
HW_RS3036	36" X 30" X 29"	Cubic Ft: 23	Ship Weight: 163	583	592	600
Freight Class: 110						
HW_RS3030	30" X 30" X 29"	Cubic Ft: 23	Ship Weight: 155	552	560	569
Freight Class: 110						

Freestanding Rectangular Shell

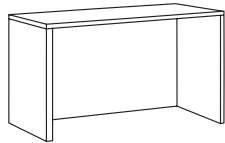

- Freestanding
- Two full legs
- Utility and mobile pedestals available

HW_RS2472	72" X 24" X 29"	Cubic Ft: 35.7	Ship Weight: 169	761	772	784
HW_RS2466	66" X 24" X 29"	Cubic Ft: 32	Ship Weight: 159	737	748	759
HW_RS2460	60" X 24" X 29"	Cubic Ft: 30.5	Ship Weight: 149	703	714	724
HW_RS2454	54" X 24" X 29"	Cubic Ft: 27.6	Ship Weight: 139	657	667	677
HW_RS2448	48" X 24" X 29"	Cubic Ft: 24.3	Ship Weight: 129	649	659	668
HW_RS2442	42" X 24" X 29"	Cubic Ft: 21.7	Ship Weight: 119	608	617	626
HW_RS2436	36" X 24" X 29"	Cubic Ft: 19.8	Ship Weight: 109	583	592	600
HW_RS2430	30" X 24" X 29"	Cubic Ft: 19.8	Ship Weight: 99	552	560	569
Freight Class: 200						

Left Rectangular Shell

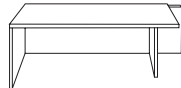
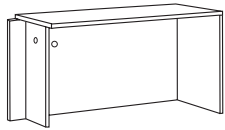

Half-depth support leg on 72", 66", 60" and 54" lengths should be relocated inward (12" from end) for increased worksurface support

- Connect with straight edge; not freestanding
- Full left, half right leg
- Grommet in modesty panel and half leg

Freight Class: 200

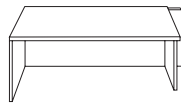

Support leg on 48", 42", 36" and 30" lengths located close to ends

HW_RS2472L	72" X 24" X 29"	Cubic Ft: 35.7	Ship Weight: 169	761	772	784
Freight Class: 200						
HW_RS2466L	66" X 24" X 29"	Cubic Ft: 32	Ship Weight: 159	737	748	759
Freight Class: 200						
HW_RS2460L	60" X 24" X 29"	Cubic Ft: 30.5	Ship Weight: 149	703	714	724
Freight Class: 200						
HW_RS2454L	54" X 24" X 29"	Cubic Ft: 27.6	Ship Weight: 138	657	667	677
Freight Class: 200						
HW_RS2448L	48" X 24" X 29"	Cubic Ft: 24.3	Ship Weight: 129	649	659	668
Freight Class: 200						
HW_RS2442L	42" X 24" X 29"	Cubic Ft: 21.7	Ship Weight: 119	608	617	626
Freight Class: 200						
HW_RS2436L	36" X 24" X 29"	Cubic Ft: 19.8	Ship Weight: 109	583	592	600
Freight Class: 110						
HW_RS2430L	30" X 24" X 29"	Cubic Ft: 19.8	Ship Weight: 99	552	560	569
Freight Class: 200						



Zone Pricing	1	2	3
--------------	---	---	---

Right Rectangular Shell

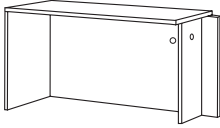

- Connect with straight edge; not freestanding
- Full right, half left leg
- Grommet in modesty panel and half leg

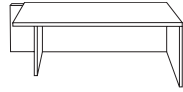

Half-depth support leg on 72", 66", 60" and 54" lengths should be relocated inward (12" from end) for increased worksurface support

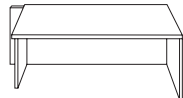

Support leg on 48", 42", 36" and 30" lengths located close to ends

HW_RS2472R	72" X 24" X 29"	Cubic Ft: 35.7	Ship Weight: 169	761	772	784
Freight Class: 200						
HW_RS2466R	66" X 24" X 29"	Cubic Ft: 32	Ship Weight: 159	737	748	759
Freight Class: 200						
HW_RS2460R	60" X 24" X 29"	Cubic Ft: 30.5	Ship Weight: 149	703	714	724
Freight Class: 200						
HW_RS2454R	54" X 24" X 29"	Cubic Ft: 27.6	Ship Weight: 138	657	667	677
Freight Class: 200						
HW_RS2448R	48" X 24" X 29"	Cubic Ft: 24.3	Ship Weight: 129	649	659	668
Freight Class: 200						
HW_RS2442R	42" X 24" X 29"	Cubic Ft: 21.7	Ship Weight: 119	608	617	626
Freight Class: 200						
HW_RS2436R	36" X 24" X 29"	Cubic Ft: 19.8	Ship Weight: 109	583	592	600
Freight Class: 110						
HW_RS2430R	30" X 24" X 29"	Cubic Ft: 19.8	Ship Weight: 99	552	560	569
Freight Class: 200						

Modular Filing

Box/File Utility Pedestal



- 3/4 height pedestal for field installation
- Pre-installed, black filing hardware
- Legal or letter filing
- Single-key front locking

Freight Class: 100

H_UP QS	15.75" x 22" x 17.75"	Cubic Ft: 7	Ship Weight: 61	660	670	680
Pulls:	BRUSHED CHROME HW	EBONY HE	BRIGHT BRASS HB	OVAL NICKEL HD	T-BAR NICKEL HV	
QS FINISHES		WC	QS PULLS		W	

Box/Box/File Utility Pedestal



- Full-to-floor box/box/file pedestal for field installation
- Pre-installed, black filing hardware
- Legal or letter filing
- Single-key front locking

Freight Class: 100

H_UP2BF	15.75" x 22" x 27.25"	Cubic Ft: 10.1	Ship Weight: 83	797	809	821
Pulls:	BRUSHED CHROME HW	EBONY HE	BRIGHT BRASS HB	OVAL NICKEL HD	T-BAR NICKEL HV	

File/File Utility Pedestal



- Full-to-floor file/file pedestal for field installation
- Pre-installed, black filing hardware
- Legal or letter filing
- Single-key front locking

Freight Class: 100

H_UPF	15.75" x 22" x 27.25"	Cubic Ft: 10.1	Ship Weight: 83	797	809	821
Pulls:	BRUSHED CHROME HW	EBONY HE	BRIGHT BRASS HB	OVAL NICKEL HD	T-BAR NICKEL HV	

Zone Pricing	1	2	3
--------------	---	---	---

Lateral File Utility Pedestal



- Full-to-floor pedestal for field installation
- Pre-installed, black filing hardware
- Legal or letter filing
- Single-key front locking

Freight Class: 100

H_ _ULF	30.5" x 22" x 27.25" Cubic Ft: 19.8	Ship Weight: 165	1001	1016	1031
Pulls:	BRUSHED CHROME HW	EBONY HE	BRIGHT BRASS HB	OVAL NICKEL HD	T-BAR NICKEL HV

Reception Stations

Left Pedestal Reception Desk

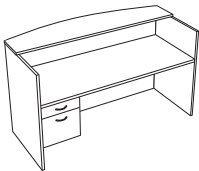

- 42" privacy height
- 18" bow front transaction counter
- Box/File left pedestal
- Pre-installed, black filing hardware
- Legal or letter filing
- Single-key locking

Freight Class: 200

H_ _7230L QS	72" x 36" x 42" Cubic Ft: 63.9	Ship Weight: 343	1788	1815	1842
	Center Drawer C		165	167	170
	Keyboard Platform K		196	199	202
Pulls:	BRUSHED CHROME HW	EBONY HE	BRIGHT BRASS HB	OVAL NICKEL HD	T-BAR NICKEL HV

QS FINISHES WC **QS PULLS W**

Right Pedestal Reception Desk

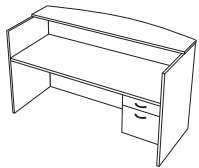

- Same description as above except:
- Box/File right pedestal

Freight Class: 200

H_ _7230R QS	72" x 36" x 42" Cubic Ft: 63.9	Ship Weight: 343	1788	1815	1842
	Center Drawer C		165	167	170
	Keyboard Platform K		196	199	202
Pulls:	BRUSHED CHROME HW	EBONY HE	BRIGHT BRASS HB	OVAL NICKEL HD	T-BAR NICKEL HV

QS FINISHES WC **QS PULLS W**

Left Pedestal Reception Return

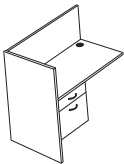

- 41" privacy height
- Box/File left pedestal
- Pre-installed, black filing hardware
- Legal or letter filing
- Grommet in top and modesty panel
- Single-key locking

Freight Class: 110

H_ _2442L QS	42" x 24" x 41" Cubic Ft: 32.9	Ship Weight: 195	1193	1211	1229
	Keyboard Platform K		196	199	202
Pulls:	BRUSHED CHROME HW	EBONY HE	BRIGHT BRASS HB	OVAL NICKEL HD	T-BAR NICKEL HV

QS FINISHES WC **QS PULLS W**

Right Pedestal Reception Return

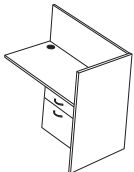

- Same description as above except:
- Box/File right pedestal

Freight Class: 110

H_ _2442R QS	42" x 24" x 41" Cubic Ft: 32.9	Ship Weight: 195	1193	1211	1229
	Keyboard Platform K		196	199	202
Pulls:	BRUSHED CHROME HW	EBONY HE	BRIGHT BRASS HB	OVAL NICKEL HD	T-BAR NICKEL HV

QS FINISHES WC **QS PULLS W**

Left Full Pedestal Reception Desk



- 42" privacy height
- 18" bow front transaction counter (field installed)
- Box/Box/File left pedestal
- Pre-installed, black filing hardware
- Legal or letter filing
- Single-key locking

Freight Class: 110

H_ _7230L2BF	72" x 36" x 42" Cubic Ft: 63.9	Ship Weight: 368	2126	2158	2190
	Center Drawer C		165	167	170
	Keyboard Platform K		196	199	202
Pulls:	BRUSHED CHROME HW	EBONY HE	BRIGHT BRASS HB	OVAL NICKEL HD	T-BAR NICKEL HV

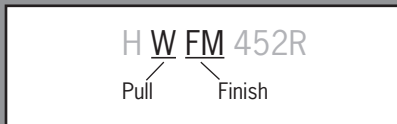
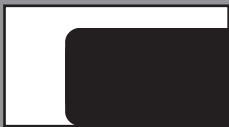

Zone Pricing	1	2	3
--------------	---	---	---

Right Full Pedestal Reception Desk

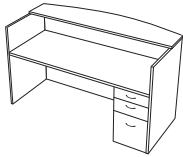

- Same description as above except:
- Box/Box/File right pedestal

Freight Class: 110

H_723OR2BF	72" x 36" x 42"	Cubic Ft: 63.9	Ship Weight: 368	2126	2158	2190	
				Center Drawer C	165	167	170
				Keyboard Platform K	196	199	202
Pulls:	BRUSHED CHROME HW	EBONY HE	BRIGHT BRASS HB	OVAL NICKEL HD	T-BAR NICKEL HV		

Left Full Pedestal Reception Return

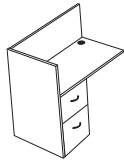

- 41" privacy height
- File/File left pedestal
- Pre-installed, black filing hardware
- Legal or letter filing
- Grommet in top and modesty panel
- Single-key locking

Freight Class: 110

H_2442LF	42" x 24" x 41"	Cubic Ft: 32.9	Ship Weight: 220	1398	1419	1440	
				Keyboard Platform K	196	199	202
Pulls:	BRUSHED CHROME HW	EBONY HE	BRIGHT BRASS HB	OVAL NICKEL HD	T-BAR NICKEL HV		

Right Full Pedestal Reception Return

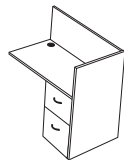

- Same description as above except:
- File/File right pedestal

Freight Class: 110

H_2442RF	42" x 24" x 41"	Cubic Ft: 32.9	Ship Weight: 220	1398	1419	1440	
				Keyboard Platform K	196	199	202
Pulls:	BRUSHED CHROME HW	EBONY HE	BRIGHT BRASS HB	OVAL NICKEL HD	T-BAR NICKEL HV		

Reception Screen for Main

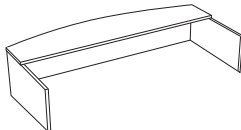

- HW_710 fits 72" x 30" desks
- HW_610 fits 66" x 30" desks
- 18" bow front transaction counter
- Non-skid rubber strips on bottom prohibit movement

Freight Class: 70

HW_710	72" x 36" x 14"	Cubic Ft: 33.6	Ship Weight: 150	1107	1124	1140
HW_610	66" x 36" x 14"	Cubic Ft: 28.9	Ship Weight: 129	1070	1086	1102

Reception Screen for Return



- Fits 42" x 24" executive height return
- Hardware included to join to main reception screen
- HW_611L fits left return
- HW_611R fits right return
- Assembly required

Freight Class: 70

HW_611L	42" x 24" x 13"	Cubic Ft: 1.5	Ship Weight: 27	245	249	252
HW_611R	42" x 24" x 13"	Cubic Ft: 1.5	Ship Weight: 27	245	249	252

Overhead Storage & Hutches

Zone Pricing	1	2	3
--------------	---	---	---

Overhead Storage Unit, Aluminum/Frosted Doors

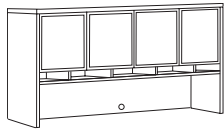

- Two storage compartments
- Four aluminum/frosted doors
- Six paper storage shelves
- 18-1/2" monitor clearance under cabinet
- Grommet in back panel

Freight Class: 125

HW_738AD	72" x 16" x 36.5"	Cubic Ft: 33.6	Ship Weight: 235	2563	2601	2640	
				Task Light I	\$124	\$126	\$128

Overhead Storage Unit

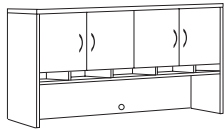

- Two storage compartments
- Four doors
- Five paper storage shelves, six shelves in H_738
- 18-1/2" monitor clearance under cabinet
- Grommet in back panel

Freight Class: 125

H_738	72" x 16" x 36.5"	Cubic Ft: 33.6	Ship Weight: 240	1754	1780	1807	
				Task Light I	\$124	\$126	\$128
H_678	66" x 16" x 36.5"	Cubic Ft: 28.3	Ship Weight: 215	1467	1489	1511	
				Task Light I	\$124	\$126	\$128
H_676	60" x 16" x 36.5"	Cubic Ft: 28.3	Ship Weight: 200	1448	1470	1491	
				Task Light I	\$124	\$126	\$128
H_538	54" x 16" x 36.5"	Cubic Ft: 24.3	Ship Weight: 180	1430	1451	1473	
				Task Light I	\$124	\$126	\$128

Pulls:	BRUSHED CHROME HW	EBONY HE	BRIGHT BRASS HB	OVAL NICKEL HD	T-BAR NICKEL HV
Locks	\$150 :Y				

Overhead Storage Unit

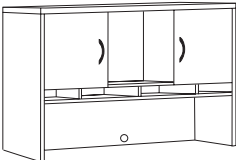

- Two compartments with doors
- Center open storage
- Four paper storage shelves
- 18-1/2" monitor clearance under cabinet
- Grommet in back panel

Freight Class: 125

H_478	48" x 16" x 36.5"	Cubic Ft: 24.3	Ship Weight: 183	1154	1171	1189	
				Task Light I	\$124	\$126	\$128
Pulls:	BRUSHED CHROME HW	EBONY HE	BRIGHT BRASS HB	OVAL NICKEL HD	T-BAR NICKEL HV		
Locks	\$150 :Y						

Overhead Storage Unit

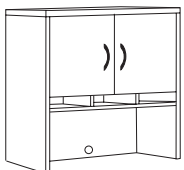

- Storage compartment
- Two doors
- Three paper storage shelves, four shelves in H_476
- 18-1/2" monitor clearance under cabinet
- Grommet in back panel

Freight Class: 125

H_456	42" x 16" x 36.5"	Cubic Ft: 24.3	Ship Weight: 163	1071	1087	1103	
				Task Light I	\$124	\$126	\$128
H_338	36" x 16" x 36.5"	Cubic Ft: 15.3	Ship Weight: 145	1034	1050	1065	
				Task Light I	\$124	\$126	\$128
H_336	30" x 16" x 36.5"	Cubic Ft: 15.3	Ship Weight: 140	973	988	1002	
				Task Light I	\$124	\$126	\$128
Pulls:	BRUSHED CHROME HW	EBONY HE	BRIGHT BRASS HB	OVAL NICKEL HD	T-BAR NICKEL HV		
Locks	\$75 :Y						



Zone Pricing	1	2	3
--------------	---	---	---

Overhead Storage Unit, Aluminum/Frosted Doors

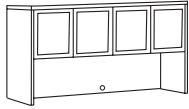

- Two storage compartments
- Four aluminum/frosted doors
- 21" monitor clearance under cabinet
- Grommet in back panel

Freight Class: 125

HW_737AD	72" x 16" x 36.5" Cubic Ft: 33.6 Ship Weight: 220	2184	2217	2250
	Task Light I	\$124	\$126	\$128

Overhead Storage Unit

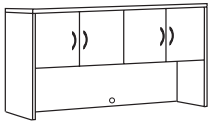

- Same features as above except:
- Four wood doors

Freight Class: 125

H_737 QS	72" x 16" x 36.5" Cubic Ft: 33.6 Ship Weight: 221	1376	1397	1417
	Task Light I	\$124	\$126	\$128
H_677	66" x 16" x 36.5" Cubic Ft: 28.3 Ship Weight: 198	1093	1109	1126
	Task Light I	\$124	\$126	\$128
H_675	60" x 16" x 36.5" Cubic Ft: 28.3 Ship Weight: 180	1077	1093	1109
	Task Light I	\$124	\$126	\$128
H_537	54" x 16" x 36.5" Cubic Ft: 28.3 Ship Weight: 170	1067	1083	1099
	Task Light I	\$124	\$126	\$128

Pulls:	BRUSHED CHROME HW	EBONY HE	BRIGHT BRASS HB	OVAL NICKEL HD	T-BAR NICKEL HV
---------------	--------------------------	-----------------	------------------------	-----------------------	------------------------

QS FINISHES	WC	QS PULLS	W
		Locks	\$150 :Y

Overhead Storage Unit

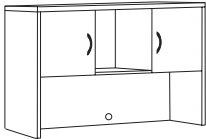

- Two compartments with doors
- Center open storage
- 21" monitor clearance under cabinet
- Grommet in back panel

Freight Class: 125

H_477	48" x 16" x 36.5" Cubic Ft: 24.3 Ship Weight: 163	874	887	900	
	Task Light I	\$124	\$126	\$128	
Pulls:	BRUSHED CHROME HW	EBONY HE	BRIGHT BRASS HB	OVAL NICKEL HD	T-BAR NICKEL HV
		Locks	\$150 :Y		

Overhead Storage Unit

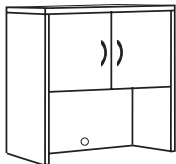

- Storage compartment
- Two doors
- 21" monitor clearance under cabinet
- Grommet in back panel

Freight Class: 125

H_455	42" x 16" x 36.5" Cubic Ft: 24.3 Ship Weight: 143	791	803	815	
	Task Light I	\$124	\$126	\$128	
H_337	36" x 16" x 36.5" Cubic Ft: 15.3 Ship Weight: 125	757	768	780	
	Task Light I	\$124	\$126	\$128	
H_335	30" x 16" x 36.5" Cubic Ft: 15.3 Ship Weight: 120	697	707	718	
	Task Light I	\$124	\$126	\$128	
Pulls:	BRUSHED CHROME HW	EBONY HE	BRIGHT BRASS HB	OVAL NICKEL HD	T-BAR NICKEL HV
		Locks	\$75 :Y		

Open Overhead Storage Unit

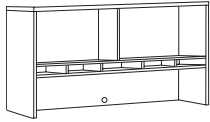

- Two cabinet compartments
- Five paper storage shelves, six shelves in HW_718
- 18-1/2" monitor clearance under cabinet
- Grommet in back panel

		Zone Pricing		1	2	3
HW_718	72" x 16" x 36.5" Cubic Ft: 33.6 Ship Weight: 200	1547	1570	1593		
	Task Light T	\$124	\$126	\$128		
HW_618	66" x 16" x 36.5" Cubic Ft: 28.3 Ship Weight: 178	1132	1149	1166		
	Task Light T	\$124	\$126	\$128		
HW_616	60" x 16" x 36.5" Cubic Ft: 28.3 Ship Weight: 160	1102	1119	1135		
	Task Light T	\$124	\$126	\$128		
HW_518	54" x 16" x 36.5" Cubic Ft: 26.2 Ship Weight: 160	1093	1109	1126		
	Task Light T	\$124	\$126	\$128		

Freight Class: 125

Open Overhead Storage Unit

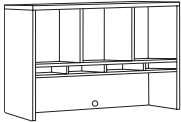

- Three cabinet compartments
- Four paper storage shelves
- 18-1/2" monitor clearance under cabinet
- Grommet in back panel

HW_418	48" x 16" x 36.5" Cubic Ft: 24.3 Ship Weight: 155	944	958	972		
	Task Light T	\$124	\$126	\$128		

Freight Class: 125

Open Overhead Storage Unit

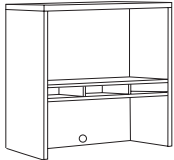

- Storage compartment
- Three paper storage shelves, four shelves in HW_416
- 18-1/2" monitor clearance under cabinet
- Grommet in back panel

HW_416	42" x 16" x 36.5" Cubic Ft: 24.3 Ship Weight: 140	862	875	888		
	Task Light T	\$124	\$126	\$128		
HW_318	36" x 16" x 36.5" Cubic Ft: 15.3 Ship Weight: 125	847	860	872		
	Task Light T	\$124	\$126	\$128		
HW_316	30" x 16" x 36.5" Cubic Ft: 15.3 Ship Weight: 120	831	843	856		
	Task Light T	\$124	\$126	\$128		

Freight Class: 125

Open Overhead Storage Unit

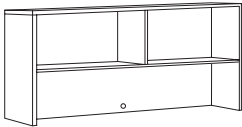

- Two cabinet compartments
- 21" monitor clearance under cabinet
- Grommet in back panel

HW_717 QS	72" x 16" x 36.5" Cubic Ft: 33.6 Ship Weight: 181	1173	1191	1208		
	Task Light T	\$124	\$126	\$128		
HW_617	66" x 16" x 36.5" Cubic Ft: 28.3 Ship Weight: 158	764	775	787		
	Task Light T	\$124	\$126	\$128		
HW_615	60" x 16" x 36.5" Cubic Ft: 28.3 Ship Weight: 140	739	750	761		
	Task Light T	\$124	\$126	\$128		
HW_517	54" x 16" x 36.5" Cubic Ft: 26 Ship Weight: 138	728	739	750		
	Task Light T	\$124	\$126	\$128		

Freight Class: 125

QS FINISHES WC

Open Overhead Storage Unit

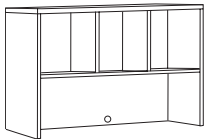

- Three cabinet compartments
- 21" monitor clearance under cabinet
- Grommet in back panel

HW_417	48" x 16" x 36.5" Cubic Ft: 24.3 Ship Weight: 135	668	678	688		
	Task Light T	\$124	\$126	\$128		

Freight Class: 125



Zone Pricing	1	2	3
--------------	---	---	---

Open Overhead Storage Unit

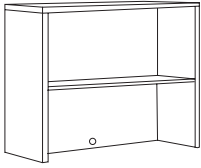

- Storage compartment
- 21" monitor clearance under cabinet
- Grommet in back panel

Freight Class: 125

HW_415	42" x 16" x 36.5"	Cubic Ft: 24.3	Ship Weight: 123	589	598	607
				Task Light I	\$124	\$126
HW_317	36" x 16" x 36.5"	Cubic Ft: 15.3	Ship Weight: 123	573	582	590
				Task Light I	\$124	\$126
HW_315	30" x 16" x 36.5"	Cubic Ft: 15.3	Ship Weight: 100	556	564	573
				Task Light I	\$124	\$126

Overhead Bookcase Hutch

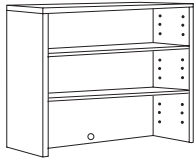

- Adjustable shelves
- Fits 36" Lateral File, MultiFile or Two Door Storage Cabinet

Freight Class: 125

HW_319	36" x 16" x 36.5"	Cubic Ft: 15.3	Ship Weight: 115	801	813	825
---------------	-------------------	----------------	------------------	------------	------------	------------

Reception Organizer

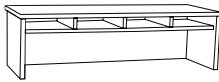

- Transaction countertop
- Four paper storage shelves

Freight Class: 70

HW_4818	48" x 18" x 14"	Cubic Ft: 12	Ship Weight: 50	832	844	857
----------------	-----------------	--------------	-----------------	------------	------------	------------

Corner Hutch with Doors

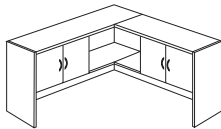

- 72" x 72" footprint
- Two compartments with doors
- Open center storage
- Components for corner hutches are 15" deep, standard overhead storage units are 16" deep
- 21" monitor clearance under cabinet
- If installed task light ordered, specify location
- Assembly required

Freight Class: 125

H_ CH7272	72" x 72" x 36.5"	Cubic Ft: 61.9	Ship Weight: 316	2664	2704	2744
				Task Light I	\$124	\$126

Pulls:	BRUSHED CHROME HW	EBONY HE	BRIGHT BRASS HB	OVAL NICKEL HD	T-BAR NICKEL HV
---------------	--------------------------	-----------------	------------------------	-----------------------	------------------------

Consists of H_872L & H_857R

Left Corner Hutch with Doors

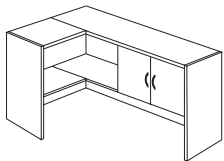

- 72" or 66" with 36" left return
- Right compartment with doors
- Open center/return storage
- Components for corner hutches are 15" deep, standard overhead storage units are 16" deep
- If installed task light ordered, specify location
- Assembly required

Freight Class: 125

H_ CH7236L	72" x 36" x 36.5"	Cubic Ft: 45.2	Ship Weight: 253	1875	1903	1931
				Task Light I	\$124	\$126

H_ CH6636L	66" x 36" x 36.5"	Cubic Ft: 39.9	Ship Weight: 223	1632	1656	1681
				Task Light I	\$124	\$126

Pulls:	BRUSHED CHROME HW	EBONY HE	BRIGHT BRASS HB	OVAL NICKEL HD	T-BAR NICKEL HV
---------------	--------------------------	-----------------	------------------------	-----------------------	------------------------

H_ CH7236L consists of H_872R & H_822L
H_ CH6636L consists of H_866R & H_822L

Right Corner Hutch with Doors

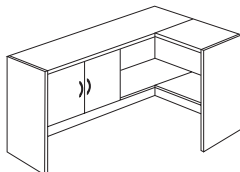

- Same description as above except:
- 72" or 66" with 36" right return
- Left compartment with doors



Freight Class: 125

H_ CH7236R	72" x 36" x 36.5"	Cubic Ft: 45.2	Ship Weight: 253	1875	1903	1931
				Task Light I	\$124	\$126

H_ CH6636R	66" x 36" x 36.5"	Cubic Ft: 39.9	Ship Weight: 223	1632	1656	1681
				Task Light I	\$124	\$126

Pulls:	BRUSHED CHROME HW	EBONY HE	BRIGHT BRASS HB	OVAL NICKEL HD	T-BAR NICKEL HV
---------------	--------------------------	-----------------	------------------------	-----------------------	------------------------

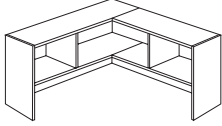
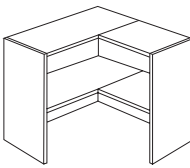
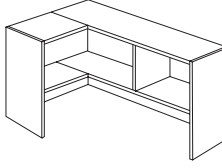
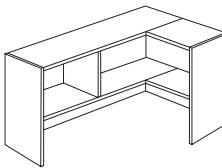
H_ CH7236R consists of H_872L & H_822R
H_ CH6636R consists of H_866L & H_822R

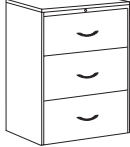
		Zone Pricing	1	2	3
 <p>Open Corner Hutch with Doors</p> <ul style="list-style-type: none"> • 72" x 72" footprint • Open storage • Components for corner hutches are 15" deep, standard overhead storage units are 16" deep • 21" monitor clearance under cabinet • If installed task light ordered, specify location • Assembly required <p>Freight Class: 125</p>	HW_CHO7272 72" x 72" x 36.5" Cubic Ft: 45.2 Ship Weight: 233	2320	2355	2390	
	Task Light T	\$124	\$126	\$128	
	Consists of H_870L & H_850R				
 <p>Open Corner Hutch</p> <ul style="list-style-type: none"> • 42" or 36" footprint • Open storage • Components for corner hutches are 15" deep, standard overhead storage units are 16" deep • 21" monitor clearance under cabinet • If installed task light ordered, specify location • Assembly required <p>Freight Class: 125</p>	HW_CHO4242 42" x 42" x 36.5" Cubic Ft: 35.9 Ship Weight: 180	1055	1071	1087	
	HW_CHO3636 36" x 36" x 36.5" Cubic Ft: 26.8 Ship Weight: 165	984	999	1014	
	Task Light T	\$124	\$126	\$128	
H_CHO4242 consists of H_840L & H_828R, H_CHO3636 consists of H_830L & H_822R					
 <p>Left Open Corner Hutch</p> <ul style="list-style-type: none"> • 72" or 66" with 36" left return • Open storage • Components for corner hutches are 15" deep, standard overhead storage units are 16" deep • 21" monitor clearance under cabinet • If installed task light ordered, specify location <p>Freight Class: 125</p>	HW_CHO7236L 42" x 36" x 36.5" Cubic Ft: 45.2 Ship Weight: 233	1497	1519	1542	
	HW_CHO6636L 72" x 36" x 36.5" Cubic Ft: 39.9 Ship Weight: 203	1308	1328	1347	
	Task Light T	\$124	\$126	\$128	
H_CHO7236L consists of H_860R & H_822L, H_CHO6636L consists of H_860R & H_822L					
 <p>Left Open Corner Hutch</p> <ul style="list-style-type: none"> • Same description as above except: • 72" or 66" with 36" right return <p>Freight Class: 125</p>	HW_CHO7236R 72" x 36" x 36.5" Cubic Ft: 45.2 Ship Weight: 233	1497	1519	1542	
	HW_CHO6636R 66" x 36" x 36.5" Cubic Ft: 39.9 Ship Weight: 203	1308	1328	1347	
	Task Light T	\$124	\$126	\$128	
H_CHO7236R consists of H_860L & H_822R, H_CHO6636R consists of H_860L & H_822R					
<h2>Storage, Filing & Bookcases</h2>					
 <p>Two-Drawer Lateral File</p> <ul style="list-style-type: none"> • Two lateral file drawers, legal or letter filing • Single-key, front-locking • Pre-installed black filing hardware • Anti-tilt counterweight standard • Hardwood bottom support rail secured with metal bracket on each end <p>Freight Class: 100</p>	H_346 QS 36.5" x 24" x 29" Cubic Ft: 19.8 Ship Weight: 185	1127	1144	1161	
	H_326 30.75" x 20.75" x 29" Cubic Ft: 14 Ship Weight: 140	1058	1074	1090	
	Pulls: BRUSHED CHROME HW EBONY HE BRIGHT BRASS HB OVAL NICKEL HD T-BAR NICKEL HV				
	QS FINISHES WC QS PULLS W				
EXTRA THICK BOTTOM \$160 H					
 <p>Three-Drawer Lateral File</p> <ul style="list-style-type: none"> • Three lateral file drawers, legal or letter filing • Pre-installed black filing hardware • Central locking (lock on front) • Anti-tilt mechanism prevents more than one drawer opening at one time • Hardwood bottom support rail secured with metal bracket on each end <p>Freight Class: 100</p>	H_3036 QS 30.75" x 20.75" x 44.5" Cubic Ft: 27.9 Ship Weight: 205	2090	2121	2153	
	Pulls: BRUSHED CHROME HW EBONY HE BRIGHT BRASS HB OVAL NICKEL HD T-BAR NICKEL HV				
	QS FINISHES WC QS PULLS W				
	EXTRA THICK BOTTOM \$240 H				

CONTEMPORARY LAMINATE



Zone Pricing	1	2	3
--------------	---	---	---

Four-Drawer Lateral File

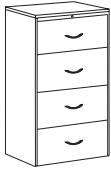

- Four lateral file drawers, legal or letter filing
- Pre-installed black filing hardware
- Central locking (lock on front)
- Anti-tilt mechanism prevents more than one drawer opening at one time
- Hardwood bottom support rail secured with metal bracket on each end

Freight Class: 100

H_426	QS	30.75" x 20.75" x 56.75" Cubic Ft: 27.9 Ship Weight: 252	2398	2434	2470
--------------	-----------	--	-------------	-------------	-------------

Pulls:	BRUSHED CHROME HW	EBONY HE	BRIGHT BRASS HB	OVAL NICKEL HD	T-BAR NICKEL HV
---------------	--------------------------	-----------------	------------------------	-----------------------	------------------------

QS FINISHES	WC	QS PULLS	W
--------------------	-----------	-----------------	----------

EXTRA THICK BOTTOM	\$320 H
---------------------------	----------------

Mobile Box/Box/File Pedestal



- Fits under work surfaces
- Pre-installed, black filing hardware
- Legal or letter filing
- Single-key front locking
- Four casters, two locking on front

Freight Class: 100

H_212BF	16" x 22.25" x 27.25" Cubic Ft: 10.3 Ship Weight: 105	982	997	1011
----------------	---	------------	------------	-------------

Pulls:	BRUSHED CHROME HW	EBONY HE	BRIGHT BRASS HB	OVAL NICKEL HD	T-BAR NICKEL HV
---------------	--------------------------	-----------------	------------------------	-----------------------	------------------------

Mobile File/File Pedestal



- Fits under work surfaces
- Pre-installed, black filing hardware
- Legal or letter filing
- Single-key front locking
- Four casters, two locking on front

Freight Class: 100

H_21F	16" x 22.25" x 27.25" Cubic Ft: 9.9 Ship Weight: 93	982	997	1011
--------------	---	------------	------------	-------------

Pulls:	BRUSHED CHROME HW	EBONY HE	BRIGHT BRASS HB	OVAL NICKEL HD	T-BAR NICKEL HV
---------------	--------------------------	-----------------	------------------------	-----------------------	------------------------

Mobile Box/File Pedestal

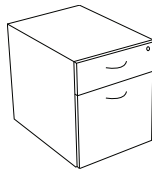

- Fits under work surfaces
- Pre-installed, black filing hardware
- Legal or letter filing
- Single-key front locking
- Four casters, two locking on front

Freight Class: 100

H_20	16" x 22.25" x 23.5" Cubic Ft: 7 Ship Weight: 85	894	907	921
-------------	--	------------	------------	------------

Pulls:	BRUSHED CHROME HW	EBONY HE	BRIGHT BRASS HB	OVAL NICKEL HD	T-BAR NICKEL HV
---------------	--------------------------	-----------------	------------------------	-----------------------	------------------------

Two-Drawer Legal File

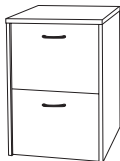

- Legal filing front-to-back
- Two legal size file drawers
- Pre-installed, black filing hardware

Freight Class: 100

H_2DLF	19" x 24" x 29" Cubic Ft: 12.2 Ship Weight: 111	1114	1131	1147
---------------	---	-------------	-------------	-------------

Pulls:	BRUSHED CHROME HW	EBONY HE	BRIGHT BRASS HB	OVAL NICKEL HD	T-BAR NICKEL HV
---------------	--------------------------	-----------------	------------------------	-----------------------	------------------------

Mobile Under Surface Storage/File

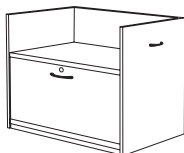

- Fits under work surfaces
- Lateral file drawer
- Pre-installed, black filing hardware
- Legal or letter filing
- Single-key front locking
- Optional seat cushion
- Casters for mobility

Freight Class: 100

H_26	30.5" x 20.5" x 26" Cubic Ft: 13.9 Ship Weight: 116	1218	1236	1255
-------------	---	-------------	-------------	-------------

Pulls:	BRUSHED CHROME HW	EBONY HE	BRIGHT BRASS HB	OVAL NICKEL HD	T-BAR NICKEL HV
---------------	--------------------------	-----------------	------------------------	-----------------------	------------------------

EXTRA THICK BOTTOM	\$80 H
---------------------------	---------------

Zone Pricing	1	2	3
--------------	---	---	---

Mobile Under Surface Storage/Cabinet

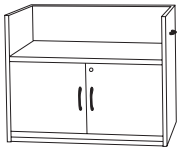

- Fits under work surfaces
- Storage cabinet with doors
- Single-key locking
- Optional seat cushion
- Casters for mobility

Freight Class: 100

H_26D	30.5" x 20.5" x 26"	Cubic Ft: 13.9	Ship Weight: 101	1058	1074	1090
--------------	---------------------	----------------	------------------	-------------	-------------	-------------

Pulls:	BRUSHED CHROME HW	EBONY HE	BRIGHT BRASS HB	OVAL NICKEL HD	T-BAR NICKEL HV
---------------	--------------------------	-----------------	------------------------	-----------------------	------------------------

Multi-File

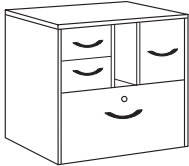

- One lateral file drawer with lock and extra thick drawer bottom
- One file drawer
- Two box drawers
- Hot projects access slot
- Pre-installed black filing hardware
- Legal or letter filing

Freight Class: 100

H_735	36.5" x 24" x 29"	Cubic Ft: 19.8	Ship Weight: 196	1335	1355	1375
--------------	-------------------	----------------	------------------	-------------	-------------	-------------

Pulls:	BRUSHED CHROME HW	EBONY HE	BRIGHT BRASS HB	OVAL NICKEL HD	T-BAR NICKEL HV
---------------	--------------------------	-----------------	------------------------	-----------------------	------------------------

Seat Cushion

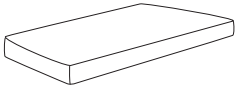

- Fits H_26 and H_26D under surface storage cabinets
- Available in any upholstery
- QUICK SHIP in QS fabric

Freight Class: 100

Cubic Ft: 4.5

Ship Weight: 4

H26	28.5" X 19" X 2.5"	St. Yardage 1.5
------------	--------------------	-----------------

Grade	1	2	3	4	5	6	7	8	9	10
Zone 1	308	339	387	409	425	464	477	538	575	621
Zone 2	313	344	393	415	431	471	484	546	584	630
Zone 3	317	349	399	421	438	478	491	554	592	640

Mobile Box/File Pedestal with Upholstered Top

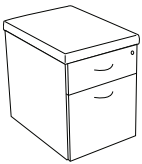

H_20S	16" X 22.25" X 23.5"	St. Yardage 1
--------------	----------------------	---------------

Grade	1	2	3	4	5	6	7	8	9	10	L	LL
Zone 1	1116	1134	1154	1171	1188	1211	1232	1255	1278	1307	1369	1488
Zone 2	1133	1151	1171	1189	1206	1229	1250	1274	1297	1327	1390	1510
Zone 3	1149	1168	1189	1206	1224	1247	1269	1293	1316	1346	1410	1533

- Pre-installed black filing hardware
- Letter or legal filing
- Front locking
- Upholstered seat on top
- Four casters, two locking

Freight Class: 100

Cubic Ft: 7

Ship Weight: 87

Pulls:	BRUSHED CHROME HW	EBONY HE	BRIGHT BRASS HB	OVAL NICKEL HD	T-BAR NICKEL HV
---------------	--------------------------	-----------------	------------------------	-----------------------	------------------------

Open Pedestal

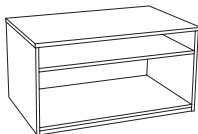

- 31.5" W x 22" D x 4.5" H open storage in top
- 34.5" W x 22" D x 11.5" H open storage in bottom

Freight Class: 100

H_36B-O	36.5" x 24" x 29"	Cubic Ft: 12.5	Ship Weight: 103	1014	1029	1044
----------------	-------------------	----------------	------------------	-------------	-------------	-------------

Pulls:	BRUSHED CHROME HW	EBONY HE	BRIGHT BRASS HB	OVAL NICKEL HD	T-BAR NICKEL HV
---------------	--------------------------	-----------------	------------------------	-----------------------	------------------------



Zone Pricing	1	2	3
--------------	---	---	---

Pedestal with Project Drawer and Open Storage



- Project drawer in top
- 11.5" high open bookcase storage in bottom

Freight Class: 100

H_36B-PD	36.5" x 24" x 29"	Cubic Ft: 12.5	Ship Weight: 114	1036	1052	1067
-----------------	-------------------	----------------	------------------	-------------	-------------	-------------

Pulls:	BRUSHED CHROME HW	EBONY HE	BRIGHT BRASS HB	OVAL NICKEL HD	T-BAR NICKEL HV
---------------	--------------------------	-----------------	------------------------	-----------------------	------------------------

Pedestal with Project Drawer and Large Storage Drawer



- Project drawer in top
- Storage Drawer below with extra-thick bottom

Freight Class: 100

H_36B-PDD	36.5" x 24" x 29"	Cubic Ft: 12.5	Ship Weight: 121	1245	1264	1282
------------------	-------------------	----------------	------------------	-------------	-------------	-------------

Pulls:	BRUSHED CHROME HW	EBONY HE	BRIGHT BRASS HB	OVAL NICKEL HD	T-BAR NICKEL HV
---------------	--------------------------	-----------------	------------------------	-----------------------	------------------------

Pedestal with project drawer and one lateral file drawer



- Project drawer in top
- Lateral File Drawer below with installed filing hardware

Freight Class: 100

H_36B-PDFD	36.5" x 24" x 29"	Cubic Ft: 12.5	Ship Weight: 136	1380	1401	1421
-------------------	-------------------	----------------	------------------	-------------	-------------	-------------

Pulls:	BRUSHED CHROME HW	EBONY HE	BRIGHT BRASS HB	OVAL NICKEL HD	T-BAR NICKEL HV
---------------	--------------------------	-----------------	------------------------	-----------------------	------------------------

EXTRA THICK BOTTOM \$80 H

Seat Cushion

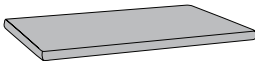

- Fits on 36½" x 24" storage pedestals above
- Available in any upholstery
- Quick ship in QS upholsteries

Freight Class: 100

Cubic Ft: 4.5

Ship Weight: 6

H36	36" x 24" x 2.5"	St. Yardage 1.75
------------	------------------	------------------

Grade	1	2	3	4	5	6	7	8	9	10
Zone 1	340	366	401	426	452	491	526	565	599	643
Zone 2	345	371	407	432	459	498	534	573	608	653
Zone 3	350	377	413	439	466	506	542	582	617	662

Bookcase

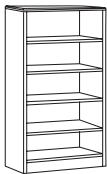

- 84" = 5 adjustable shelves
- 72" = 4 adjustable shelves
- 60" = 3 adjustable shelves
- Bottom shelf fixed
- All shelves 1" thick
- AdvantEdge front edge
- Back panel finished on one side
- Shelves adjustable every 1.25"

Freight Class: 125

HW_60	36" x 12" x 60"	Cubic Ft: 21	Ship Weight: 121	943	957	971
--------------	-----------------	--------------	------------------	------------	------------	------------

HW_72	36" x 12" x 72"	Cubic Ft: 24.7	Ship Weight: 149	1069	1085	1101
--------------	-----------------	----------------	------------------	-------------	-------------	-------------

HW_84	36" x 12" x 84"	Cubic Ft: 29	Ship Weight: 178	1144	1161	1178
--------------	-----------------	--------------	------------------	-------------	-------------	-------------

Bookcase



- HW_48 same as above except 2 adjustable shelves (shown)
- HW_36 same as above except 1 adjustable shelf
- Shelves adjustable every 1.25"

Freight Class: 125

HW_36	36" x 12" x 36"	Cubic Ft: 13	Ship Weight: 85	646	656	665
--------------	-----------------	--------------	-----------------	------------	------------	------------

HW_48	36" x 12" x 48"	Cubic Ft: 16.8	Ship Weight: 107	684	694	705
--------------	-----------------	----------------	------------------	------------	------------	------------

FINISH SELECTION

BLACK **E** | BOARDWALK **BW** | DRIFTWOOD **DW** | ESPRESSO **X** |
 GRAPHITE **GP** | MAHOGANY **M** | NATURAL MAPLE **FM** | SHORELINE **SL** |
 WINDSOR CHERRY **WC** |

Zone Pricing	1	2	3
--------------	---	---	---

Five Shelf Bookcase

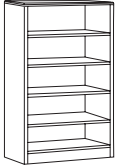

- Three adjustable shelves
- Bottom and second-from-bottom shelves fixed
- All shelves 1" thick
- AdvantEdge front edge
- Back panel 3/4" thick, finished on both sides
- Shelves adjustable every 1.25"

Freight Class: 125

HW_65 QS	36" x 16" x 65.5"	Cubic Ft: 31.8	Ship Weight: 205	993	1008	1023
-----------------	-------------------	----------------	------------------	------------	-------------	-------------

QS FINISHES WC

Bookcase with Doors

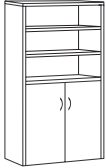

- All shelves 1" thick
- AdvantEdge front edge
- Back panel 3/4" thick, finished both sides
- Two adjustable and one fixed shelves in top
- One adjustable shelf behind doors in bottom

Freight Class: 125

HW_652D	36" x 16" x 65.5"	Cubic Ft: 31.8	Ship Weight: 222	1291	1310	1330
----------------	-------------------	----------------	------------------	-------------	-------------	-------------

Pulls:	BRUSHED CHROME HW	EBONY HE	BRIGHT BRASS HB	OVAL NICKEL HD	T-BAR NICKEL HV
---------------	--------------------------	-----------------	------------------------	-----------------------	------------------------

Curved Corner Bookcase - 65.5" High

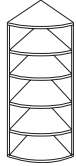

- Fits in corner at end of workstation
- Five shelf storage
- Four adjustable shelves
- Bottom shelf fixed
- All shelves 1" thick
- AdvantEdge front edge
- Shelves adjustable every 1.25"

Freight Class: 125

HW_CB65	24" x 24" x 65.5"	Cubic Ft: 31.6	Ship Weight: 182	1064	1080	1096
----------------	-------------------	----------------	------------------	-------------	-------------	-------------

Curved Corner Bookcase - 29" High

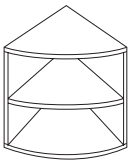

- Two sizes
- Fits in corner at end of work surface
- Middle shelf adjustable
- All shelves 1" thick
- AdvantEdge front edge

Freight Class: 125

HW_CB29	24" x 24" x 29"	Cubic Ft: 19.4	Ship Weight: 115	684	694	705
----------------	-----------------	----------------	------------------	------------	------------	------------

HW_CB2930	30" x 30" x 29"	Cubic Ft: 19.4	Ship Weight: 140	819	831	844
------------------	-----------------	----------------	------------------	------------	------------	------------

Storage & Conference Accessories

Mobile Audio/Visual Cabinet

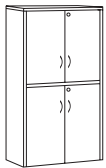

- Full-opening doors
- Upper/lower locks
- Up to 29", 150-lb. TV
- Pullout 360-degree swivel TV shelf
- Adjustable DVD/BlueRay shelf at top
- Two adjustable shelves in bottom
- Shelf and back grommets
- 400 lb. Capacity
- Handhold and casters for easy movement

Freight Class: 125

H_65AV	36.5" x 24" x 65.5"	Cubic Ft: 43.1	Ship Weight: 326	2858	2901	2944
---------------	---------------------	----------------	------------------	-------------	-------------	-------------

Pulls:	BRUSHED CHROME HW	EBONY HE	BRIGHT BRASS HB	OVAL NICKEL HD	T-BAR NICKEL HV
---------------	--------------------------	-----------------	------------------------	-----------------------	------------------------

Mobile Media Stand

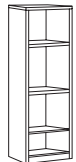

- Three adjustable shelves
- Cords drop behind shelves
- Grommets in back for wire management
- Handhold and casters for easy movement

Freight Class: 125

HW_MMS	24" x 24" x 65.5"	Cubic Ft: 31.6	Ship Weight: 192	1419	1440	1462
---------------	-------------------	----------------	------------------	-------------	-------------	-------------



Storage Cabinet



- Storage compartment 34" x 19-5/8" x 34"
- Two adjustable shelves in storage compartment
- Two lateral file drawers, legal or letter filing
- Single-key, frontlocking file cabinet
- Hardwood bottom support rail secured with metal bracket on each end

Freight Class: 125

		Zone Pricing		
		1	2	3
H_ _65STOR QS	36.5" x 24" x 65.5" Cubic Ft: 40.3 Ship Weight: 300	1915	1944	1972
Pulls:	BRUSHED CHROME HW EBONY HE BRIGHT BRASS HB OVAL NICKEL HD T-BAR NICKEL HV			
	QS FINISHES WC QS PULLS W			
	EXTRA THICK BOTTOM			\$160 H

Wardrobe

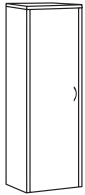

- Coat rod mounted side-to-side
- Adjustable shelf near bottom
- H_ _65WDL - Door hinge on left
- H_ _65WDR - Door hinge on right
- Shown with left hinge

Freight Class: 125

H_ _65WDL	24" x 24" x 65.5" Cubic Ft: 31.6 Ship Weight: 130	1350	1370	1391
H_ _65WDR	24" x 24" x 65.5" Cubic Ft: 31.6 Ship Weight: 130	1350	1370	1391
Pulls:	BRUSHED CHROME HW EBONY HE BRIGHT BRASS HB OVAL NICKEL HD T-BAR NICKEL HV			

Left 3-In-1 Storage

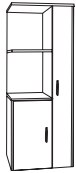

- Coat rod in wardrobe side on right
- One adjustable and one fixed shelf in top left
- Storage bottom left with one adjustable shelf

Freight Class: 125

H_ _65TL	24" x 24" x 65.5" Cubic Ft: 31.6 Ship Weight: 208	1686	1711	1737
Pulls:	BRUSHED CHROME HW EBONY HE BRIGHT BRASS HB OVAL NICKEL HD T-BAR NICKEL HV			

Right 3-In-1 Storage

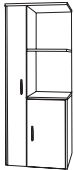

- Coat rod in top wardrobe left side
- One adjustable and one fixed shelf in right top
- Storage bottom right with one adjustable shelf

Freight Class: 125

H_ _65TR	24" x 24" x 65.5" Cubic Ft: 31.6 Ship Weight: 208	1686	1711	1737
Pulls:	BRUSHED CHROME HW EBONY HE BRIGHT BRASS HB OVAL NICKEL HD T-BAR NICKEL HV			

Personal Tower, Right

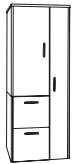

- Coat rod in wardrobe on right
- Storage cabinet with door above drawers with one adjustable shelf
- H_ _65PTR - Two file drawers (shown)
- H_ _65PTR2BF - Two box and one file drawer

Freight Class: 125

H_ _65PTR	24" x 24" x 65.5" Cubic Ft: 31.6 Ship Weight: 255	2078	2109	2140
H_ _65PTR2BF	24" x 24" x 65.5" Cubic Ft: 31.6 Ship Weight: 255	2198	2231	2264
Pulls:	BRUSHED CHROME HW EBONY HE BRIGHT BRASS HB OVAL NICKEL HD T-BAR NICKEL HV			

Personal Tower, Left

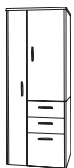

- Coat rod in wardrobe on left
- Storage cabinet with door above drawers with one adjustable shelf
- H_ _65PTL - Two file drawers
- H_ _65PTL2BF - Two box and one file drawer (shown)

Freight Class: 125

H_ _65PTL	24" x 24" x 65.5" Cubic Ft: 31.6 Ship Weight: 255	2078	2109	2140
H_ _65PTL2BF	24" x 24" x 65.5" Cubic Ft: 31.6 Ship Weight: 255	2198	2231	2264
Pulls:	BRUSHED CHROME HW EBONY HE BRIGHT BRASS HB OVAL NICKEL HD T-BAR NICKEL HV			

Zone Pricing	1	2	3
--------------	---	---	---

Full-size Personal Tower, Right



- Coat rod in wardrobe behind full door
- Open storage cabinet with one adjustable in-wardrobe shelf above drawers
- H_65PTRS - Two file drawers (shown)
- H_65PTR2BFS - Two box and one file drawer

Freight Class: 125

H_65PTRS	30" x 24" x 65.5"	Cubic Ft: 36	Ship Weight: 262	2200	2233	2266
H_65PTR2BFS	30" x 24" x 65.5"	Cubic Ft: 36	Ship Weight: 262	2320	2355	2390

Pulls:	BRUSHED CHROME HW	EBONY HE	BRIGHT BRASS HB	OVAL NICKEL HD	T-BAR NICKEL HV
---------------	--------------------------	-----------------	------------------------	-----------------------	------------------------

Full-size Personal Tower, Left



- Coat rod in wardrobe behind full door
- Open storage cabinet with one adjustable in-wardrobe shelf above drawers
- H_65PTLS - Two file drawers (shown)
- H_65PTL2BFS - Two box and one file drawer

Freight Class: 125

H_65PTLS	30" x 24" x 65.5"	Cubic Ft: 36	Ship Weight: 262	2200	2233	2266
H_65PTL2BFS	30" x 24" x 65.5"	Cubic Ft: 36	Ship Weight: 262	2320	2355	2390

Pulls:	BRUSHED CHROME HW	EBONY HE	BRIGHT BRASS HB	OVAL NICKEL HD	T-BAR NICKEL HV
---------------	--------------------------	-----------------	------------------------	-----------------------	------------------------

MultiUse Wardrobe/Storage

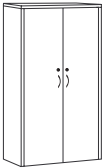

- Two-door storage area
- Coat rod mounted side-to-side on left
- Four adjustable shelves right
- Both sides drilled for adjustable shelves
- 3/4" thick shelves
- Individually locking doors

Freight Class: 125

H_65DWD	36.5" x 24" x 65.5"	Cubic Ft: 40.3	Ship Weight: 350	2287	2321	2356
----------------	---------------------	----------------	------------------	-------------	-------------	-------------

Pulls:	BRUSHED CHROME HW	EBONY HE	BRIGHT BRASS HB	OVAL NICKEL HD	T-BAR NICKEL HV
---------------	--------------------------	-----------------	------------------------	-----------------------	------------------------

Two-Door Storage Cabinet

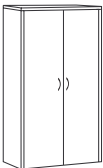

- Two-door storage cabinet
- Four full width adjustable shelves
- 1" thick shelves

Freight Class: 125

H_65DS	36.5" x 24" x 65.5"	Cubic Ft: 40.3	Ship Weight: 300	2168	2201	2233
---------------	---------------------	----------------	------------------	-------------	-------------	-------------

Pulls:	BRUSHED CHROME HW	EBONY HE	BRIGHT BRASS HB	OVAL NICKEL HD	T-BAR NICKEL HV
---------------	--------------------------	-----------------	------------------------	-----------------------	------------------------

Two-Door Storage Unit

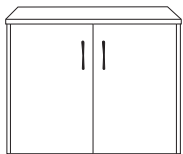

- Two hinged doors
- One adjustable shelf in storage area
- Leveling glides
- Inside dimension 34" x 21" x 25"

Freight Class: 100

H_732	36.5" x 24" x 29"	Cubic Ft: 19.2	Ship Weight: 133	1023	1038	1054
--------------	-------------------	----------------	------------------	-------------	-------------	-------------

Pulls:	BRUSHED CHROME HW	EBONY HE	BRIGHT BRASS HB	OVAL NICKEL HD	T-BAR NICKEL HV
---------------	--------------------------	-----------------	------------------------	-----------------------	------------------------

Mobile Server Credenza

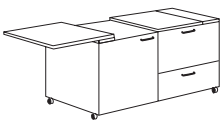

- Flip-open tops with concealed hinges extends top surface to 72" wide and 31.75" high
- Inside top/right drawer dimensions: 20" x 18" x 13" (Holds 2-liter bottles upright)
- Bottom/right drawer dimensions: 20" x 18" x 8"
- Door compartment on left includes nine holes for ventilation of small refrigerator, (inside dimensions 22" x 21" x 24")
- Casters for mobility
- See refrigerator on page 131

Freight Class: 125

H_2248	48" x 24" x 30.75"	Cubic Ft: 25.3	Ship Weight: 228	1719	1745	1771
---------------	--------------------	----------------	------------------	-------------	-------------	-------------

Pulls:	BRUSHED CHROME HW	EBONY HE	BRIGHT BRASS HB	OVAL NICKEL HD	T-BAR NICKEL HV
---------------	--------------------------	-----------------	------------------------	-----------------------	------------------------



Zone Pricing	1	2	3
--------------	---	---	---

Mobile Server Cart



- Flip-open top extends worksurface to 36.25" wide and 31.75" high
- Top drawer 20" x 18" x 13" H (Holds 2-liter soda bottles upright)
- Bottom drawer 20" x 18" x 8" H
- Casters for mobility
- 3/8" thick drawer bottoms

Freight Class: 100

H_2224	24.25" x 24.5" x 30.75"	Cubic Ft: 16.7	Ship Weight: 150	1516	1539	1561
---------------	-------------------------	----------------	------------------	-------------	-------------	-------------

Pulls:	BRUSHED CHROME HW	EBONY HE	BRIGHT BRASS HB	OVAL NICKEL HD	T-BAR NICKEL HV
---------------	--------------------------	-----------------	------------------------	-----------------------	------------------------

Mobile Teaming Board

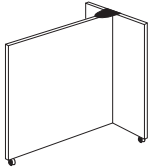

- Dry-Erase whiteboard both sides
- Includes markers, eraser and mountable holder
- Tackboard available below
- Assembly required
- Casters for mobility

Freight Class: 100

HW_MTB	49" x 24" x 72"	Cubic Ft: 13.2	Ship Weight: 178	1201	1219	1237
---------------	-----------------	----------------	------------------	-------------	-------------	-------------

Tackboard for Mobile Teaming Board

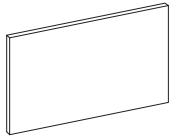

- Fully tackable surface
- Core 952 Macro fabric
- Mounts to Mobile Teaming Board

Freight Class: 100

HW_MTBTB	47.5" x 35.5"	Cubic Ft: 3.1	Ship Weight: 20	524	532	540
-----------------	---------------	---------------	-----------------	------------	------------	------------

Marker Board

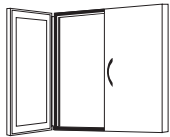

- Marker board 45" x 42" inside
- Eraser and market kit included
- Reverse-side of doors feature grey fabric-covered tackable surface
- Magnetic door catches
- Optional pre-installed projection screen; add P to model number-see below for pricing
- 3/4" thick TFL doors
- Case is 1" thick solid hardwood

Freight Class: 100

H_MB	48" x 4.5" x 48"	Cubic Ft: 12.2	Ship Weight: 141	1290	1309	1329
-------------	------------------	----------------	------------------	-------------	-------------	-------------

Pulls:	BRUSHED CHROME HW	EBONY HE	BRIGHT BRASS HB	OVAL NICKEL HD	T-BAR NICKEL HV
---------------	--------------------------	-----------------	------------------------	-----------------------	------------------------

Projection Screen

- Roll down projection screen fits inside Marker Board
- Requires removal of fascia board for installation
- Must be factory-installed

Freight Class: 100

PROJECTSCREEN	40" x 48"	Cubic Ft: 1.21	Ship Weight: 5	157	159	162
----------------------	-----------	----------------	----------------	------------	------------	------------

Standing Lectern

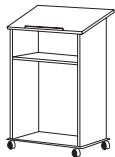

- Pencil catch on angled surface is painted black on solid colors
- 2 storage shelves for presentation materials
- 4 casters included for field installation, 2 locking

Freight Class: 125

HW_LS46C	24" x 15" x 46"	Cubic Ft: 13.8	Ship Weight: 83	803	815	827
-----------------	-----------------	----------------	-----------------	------------	------------	------------

Adjustable Height Computer Table



- Top height adjusts from 29" sitting position to 46" standing position
- Manual crank stores under top when not in use
- Four casters, two locking
- Ships in two cartons
- Assembly required

Freight Class: 85

HW_2630AT	30" x 26" x 29"	Cubic Ft: 9.8	Ship Weight: 78	1942	1971	2000
------------------	-----------------	---------------	-----------------	-------------	-------------	-------------

				Zone Pricing	1	2	3
Mobile Height-Adjustable Pie Shape Table  <ul style="list-style-type: none"> • Pie-shape top • 10" pneumatic height adjustment for sitting or standing work area • Five-star base with locking casters • Freestanding 	HW_ET24	24" x 28" x 23-33"	Cubic Ft: 16.7 Ship Weight: 41	946	960	974	
	HW_ET30	30" x 35" x 23-33"	Cubic Ft: 16.7 Ship Weight: 51	1002	1017	1032	

Freight Class: 125

Mobile Height-Adjustable Bullet Shape Table  <ul style="list-style-type: none"> • Bullet-shape top • 10" pneumatic height adjustment for sitting or standing work area • Five-star base with locking casters • Freestanding 	HW_MT24	24" x 28" x 23-33"	Cubic Ft: 16.7 Ship Weight: 45	804	816	828
	HW_MT30	30" x 28" x 23-33"	Cubic Ft: 16.7 Ship Weight: 60	870	883	896

Freight Class: 125

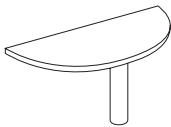
Spanner Island  <ul style="list-style-type: none"> • Top + column • 5" diameter base with powdercoated black finish and leveling glide • Use at end of back-to-back returns, shells or credenzas • Assembly required 	HW_ST60	60" x 30" x 29"	Cubic Ft: 7.21 Ship Weight: 96	890	903	917
	HW_ST48	48" x 24" x 29"	Cubic Ft: 4.8 Ship Weight: 66	737	748	759

Freight Class: 85

Wall Mount Cabinets

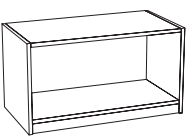
30" Wall Mount Cabinet, Open  <ul style="list-style-type: none"> • One open storage compartment • Mounts on wall • Includes hardwood wall cleat and screws for mounting into wooden wall studs for safety 	H_30WM	30" x 16.5" x 16.5"	Cubic Ft: 7.6 Ship Weight: 48	618	628	637
---	---------------	---------------------	-------------------------------	------------	------------	------------

Freight Class: 125

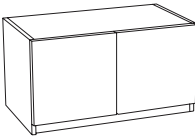
30" Wall Mount Cabinet, 2 Doors  <ul style="list-style-type: none"> • One storage compartment behind two doors • Mounts on wall • Includes hardwood wall cleat and screws for mounting into wooden wall studs for safety 	H_30WMS	30" x 16.5" x 16.5"	Cubic Ft: 7.6 Ship Weight: 68	710	721	732
--	----------------	---------------------	-------------------------------	------------	------------	------------

Freight Class: 125

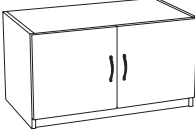
30" Wall Mount Cabinet, 2 Doors, Pulls  <ul style="list-style-type: none"> • One storage compartment behind two doors with pulls • Mounts on wall • Includes hardwood wall cleat and screws for mounting into wooden wall studs for safety 	H_30WMS	30" x 16.5" x 16.5"	Cubic Ft: 7.6 Ship Weight: 69	749	761	772
--	----------------	---------------------	-------------------------------	------------	------------	------------

Freight Class: 125

CONTEMPORARY LAMINATE



Zone Pricing	1	2	3
--------------	---	---	---

36" Wall Mount Cabinet, Open



- One open storage compartment
- Mounts on wall
- Includes hardwood wall cleat and screws for mounting into wooden wall studs for safety

Freight Class: 125

H_36WM	36" x 16.5" x 16.5"	Cubic Ft: 8.3	Ship Weight: 55	732	743	754
--------	---------------------	---------------	-----------------	-----	-----	-----

36" Wall Mount Cabinet, 2 Doors

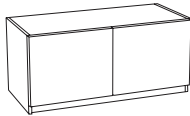

- One storage compartment behind two doors
- Mounts on wall
- Includes hardwood wall cleat and screws for mounting into wooden wall studs for safety

Freight Class: 125

H_36WMS	36" x 16.5" x 16.5"	Cubic Ft: 8.3	Ship Weight: 76	857	870	882
---------	---------------------	---------------	-----------------	-----	-----	-----

36" Wall Mount Cabinet, 2 Doors, Pulls

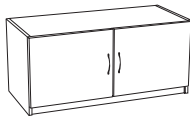

- One storage compartment behind two doors with pulls
- Mounts on wall
- Includes hardwood wall cleat and screws for mounting into wooden wall studs for safety

Freight Class: 125

H_36WMS	36" x 16.5" x 16.5"	Cubic Ft: 8.3	Ship Weight: 77	896	909	922
---------	---------------------	---------------	-----------------	-----	-----	-----

42" Wall Mount Cabinet, Open



- One open storage compartment
- Mounts on wall
- Includes hardwood wall cleat and screws for mounting into wooden wall studs for safety

Freight Class: 125

H_42WM	42" x 16.5" x 16.5"	Cubic Ft: 10.4	Ship Weight: 63	812	825	837
--------	---------------------	----------------	-----------------	-----	-----	-----

42" Wall Mount Cabinet, 2

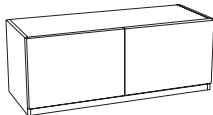

- One storage compartment behind two doors
- Mounts on wall
- Includes hardwood wall cleat and screws for mounting into wooden wall studs for safety

Freight Class: 125

H_42WMS	42" x 16.5" x 16.5"	Cubic Ft: 10.4	Ship Weight: 85	954	969	983
---------	---------------------	----------------	-----------------	-----	-----	-----

42" Wall Mount Cabinet, 2 Doors, Pulls

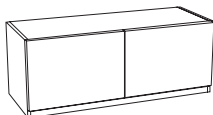

- One storage compartment behind two doors with pulls
- Mounts on wall
- Includes hardwood wall cleat and screws for mounting into wooden wall studs for safety

Freight Class: 125

H_42WMS	42" x 16.5" x 16.5"	Cubic Ft: 10.4	Ship Weight: 86	993	1008	1023
---------	---------------------	----------------	-----------------	-----	------	------

48" Wall Mount Cabinet, Open

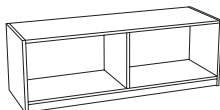

- Two open storage compartments
- Mounts on wall
- Includes hardwood wall cleat and screws for mounting into wooden wall studs for safety

Freight Class: 125

H_48WM	48" x 16.5" x 16.5"	Cubic Ft: 11.8	Ship Weight: 70	881	894	908
--------	---------------------	----------------	-----------------	-----	-----	-----

Zone Pricing	1	2	3
--------------	---	---	---

48" Wall Mount Cabinet, 3 Doors

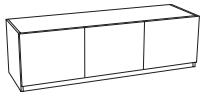

- Two storage compartments behind three doors (2 left hinges, 1 right hinge)
- Mounts on wall
- Includes hardwood wall cleat and screws for mounting into wooden wall studs for safety

Freight Class: 125

H_48WMSL	48" x 16.5" x 16.5" Cubic Ft: 11.8 Ship Weight: 102	1031	1047	1062
-----------------	---	-------------	-------------	-------------

48" Wall Mount Cabinet, 3 Doors, Pulls

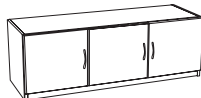

- Two storage compartments behind three doors with pulls (2 left hinges, 1 right hinge)
- Mounts on wall
- Includes hardwood wall cleat and screws for mounting into wooden wall studs for safety

Freight Class: 125

H_48WMSL	48" x 16.5" x 16.5" Cubic Ft: 11.8 Ship Weight: 103	1089	1106	1122
-----------------	---	-------------	-------------	-------------

48" Wall Mount Cabinet, 3 Doors

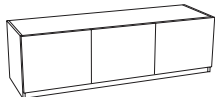

- Two storage compartments behind three doors (1 left hinge, 2 right hinges)
- Mounts on wall
- Includes hardwood wall cleat and screws for mounting into wooden wall studs for safety

Freight Class: 125

H_48WMSR	48" x 16.5" x 16.5" Cubic Ft: 11.8 Ship Weight: 102	1031	1047	1062
-----------------	---	-------------	-------------	-------------

48" Wall Mount Cabinet, 3 Doors, Pulls

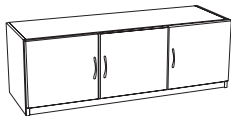

- Two storage compartments behind three doors with pulls (1 left hinge, 2 right hinges)
- Mounts on wall
- Includes hardwood wall cleat and screws for mounting into wooden wall studs for safety

Freight Class: 125

H_48WMSR	48" x 16.5" x 16.5" Cubic Ft: 11.8 Ship Weight: 103	1089	1106	1122
-----------------	---	-------------	-------------	-------------

54" Wall Mount Cabinet, Open

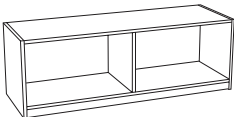

- Two open storage compartments
- Mounts on wall
- Includes hardwood wall cleat and screws for mounting into wooden wall studs for safety

Freight Class: 125

H_54WM	54" x 16.5" x 16.5" Cubic Ft: 13.2 Ship Weight: 77	961	975	990
---------------	--	------------	------------	------------

54" Wall Mount Cabinet, 3 Doors

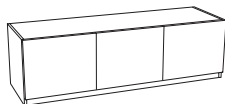

- Two storage compartments behind three doors (2 left hinges, 1 right hinge)
- Mounts on wall
- Includes hardwood wall cleat and screws for mounting into wooden wall studs for safety

Freight Class: 125

H_54WMSL	54" x 16.5" x 16.5" Cubic Ft: 13.2 Ship Weight: 110	1089	1105	1122
-----------------	---	-------------	-------------	-------------

54" Wall Mount Cabinet, 3 Doors, Pulls

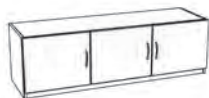

- Two storage compartments behind three doors with pulls (2 left hinges, 1 right hinge)
- Mounts on wall
- Includes hardwood wall cleat and screws for mounting into wooden wall studs for safety

Freight Class: 125

H_54WMSL	54" x 16.5" x 16.5" Cubic Ft: 13.2 Ship Weight: 111	1147	1164	1182
-----------------	---	-------------	-------------	-------------



Zone Pricing	1	2	3
--------------	---	---	---

54" Wall Mount Cabinet, 3 Doors

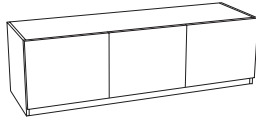

- One open storage compartment
- Mounts on wall
- Includes hardwood wall cleat and screws for mounting into wooden wall studs for safety

Freight Class: 125

H_54WMSR	54" x 16.5" x 16.5" Cubic Ft: 13.2 Ship Weight: 110	1089	1105	1122
-----------------	---	-------------	-------------	-------------

54" Wall Mount Cabinet, 3 Doors, Pulls

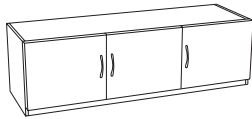

- Two storage compartments behind three doors with pulls (1 left hinge, 2 right hinges)
- Mounts on wall
- Includes hardwood wall cleat and screws for mounting into wooden wall studs for safety

Freight Class: 125

H_54WMSR	54" x 16.5" x 16.5" Cubic Ft: 13.2 Ship Weight: 111	1147	1164	1182
-----------------	---	-------------	-------------	-------------

60" Wall Mount Cabinet, Open

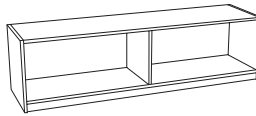

- Two storage compartments behind three doors with pulls (1 left hinge, 2 right hinges)
- Mounts on wall
- Includes hardwood wall cleat and screws for mounting into wooden wall studs for safety

Freight Class: 125

H_60WM	60" x 16.5" x 16.5" Cubic Ft: 14.6 Ship Weight: 96	1025	1040	1055
---------------	--	-------------	-------------	-------------

60" Wall Mount Cabinet, 4 Doors

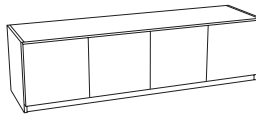

- Two storage compartments behind four doors
- Mounts on wall
- Includes hardwood wall cleat and screws for mounting into wooden wall studs for safety

Freight Class: 125

H_60WMS	60" x 16.5" x 16.5" Cubic Ft: 14.6 Ship Weight: 126	1169	1186	1204
----------------	---	-------------	-------------	-------------

60" Wall Mount Cabinet, 4 Doors, Pulls

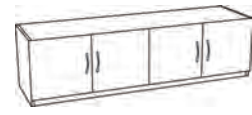

- Two storage compartments behind four doors with pulls
- Mounts on wall
- Includes hardwood wall cleat and screws for mounting into wooden wall studs for safety

Freight Class: 125

H_60WMS	60" x 16.5" x 16.5" Cubic Ft: 14.6 Ship Weight: 127	1247	1265	1284
----------------	---	-------------	-------------	-------------

66" Wall Mount Cabinet, Open

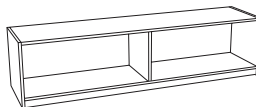

- Two open storage compartments
- Mounts on wall
- Includes hardwood wall cleat and screws for mounting into wooden wall studs for safety

Freight Class: 125

H_66WM	66" x 16.5" x 16.5" Cubic Ft: 16.0 Ship Weight: 103	1128	1145	1162
---------------	---	-------------	-------------	-------------

66" Wall Mount Cabinet, 4 Doors

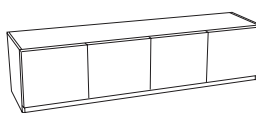

- Two storage compartments behind four doors with pulls
- Mounts on wall
- Includes hardwood wall cleat and screws for mounting into wooden wall studs for safety

Freight Class: 125

H_66WMS	66" x 16.5" x 16.5" Cubic Ft: 16.0 Ship Weight: 135	1305	1325	1344
----------------	---	-------------	-------------	-------------

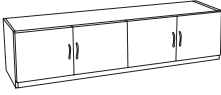
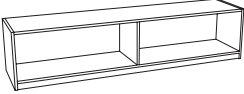
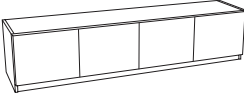
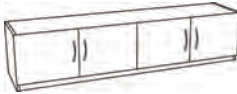
		Zone Pricing	1	2	3
66" Wall Mount Cabinet, 4 Doors, Pulls  <ul style="list-style-type: none"> • Two storage compartments behind four doors with pulls • Mounts on wall • Includes hardwood wall cleat and screws for mounting into wooden wall studs for safety Freight Class: 125	H_66WMS 66" x 16.5" x 16.5" Cubic Ft: 16.0 Ship Weight: 136	1383	1404	1424	
72" Wall Mount Cabinet, Open  <ul style="list-style-type: none"> • Two open storage compartments • Mounts on wall • Includes hardwood wall cleat and screws for mounting into wooden wall studs for safety Freight Class: 125	H_72WM 72" x 16.5" x 16.5" Cubic Ft: 17.4 Ship Weight: 110	1189	1207	1225	
72" Wall Mount Cabinet, 4 Doors  <ul style="list-style-type: none"> • Two storage compartments behind four doors • Mounts on wall • Includes hardwood wall cleat and screws for mounting into wooden wall studs for safety Freight Class: 125	H_72WMS 72" x 16.5" x 16.5" Cubic Ft: 17.4 Ship Weight: 150	1375	1396	1416	
72" Wall Mount Cabinet, 4 Doors, Pulls  <ul style="list-style-type: none"> • Two storage compartments behind four doors with pulls • Mounts on wall • Includes hardwood wall cleat and screws for mounting into wooden wall studs for safety Freight Class: 125	H_72WMS 72" x 16.5" x 16.5" Cubic Ft: 17.4 Ship Weight: 151	1453	1474	1496	



Hyperwork Education provides modular storage furniture for the classroom. Cubby storage modules are designed to create perimeter storage and auxiliary seating within the K-3 classroom. Cubby storage is offered in 2-, 3- and 4-level heights ideal for elementary and middle schools.

Cubby storage units and lockers can be adapted to the specific needs of individual classrooms by adding doors to conceal or secure personal items. The addition of shelves transforms the storage area into bin or tub storage for younger students.

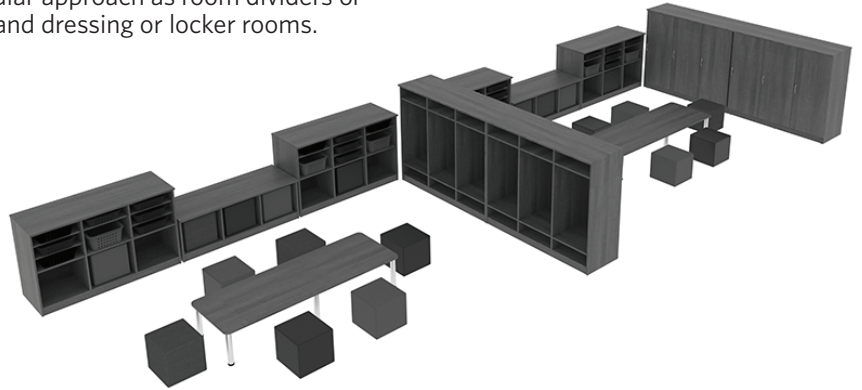

Locker cabinets with or without doors in single, double or triple widths with finished backs offer a flexible and modular approach as room dividers or for band dressing or locker rooms.

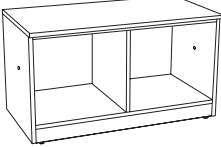
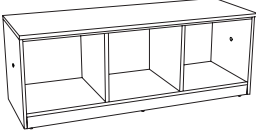
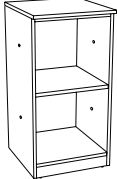

Cubby Storage				Zone Pricing	1	2	3
1x1 Open Ottoman/Cubby Storage							
	<ul style="list-style-type: none"> • One open ottoman/cubby storage area • Prebored for adjustable shelves 						
Freight Class: 125							
1x2 Open Ottoman/Cubby Storage							
	<ul style="list-style-type: none"> • Two open ottoman/cubby storage areas • Single level • Prebored for adjustable shelves 						
Freight Class: 125							
1x3 Open Ottoman/Cubby Storage							
	<ul style="list-style-type: none"> • Three open ottoman/cubby storage areas • Single level • Prebored for adjustable shelves 						
Freight Class: 125							
2x1 Open Ottoman/Cubby Storage							
	<ul style="list-style-type: none"> • Two open ottoman/cubby storage areas • Two levels high • Prebored for adjustable shelves 						
Freight Class: 125							
H_1-1	19" X 20" X 21.25"	Cubic Ft: 6.2	Ship Weight: 35	560	568	577	
H_1-2	37" X 20" X 21.25"	Cubic Ft: 11.4	Ship Weight: 55	793	805	817	
H_1-3	55" X 20" X 21.25"	Cubic Ft: 16.1	Ship Weight: 75	942	956	970	
H_2-1	19" X 20" X 37.5"	Cubic Ft: 10.4	Ship Weight: 55	696	706	717	

FINISH SELECTION

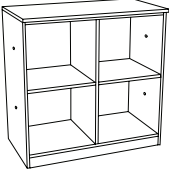
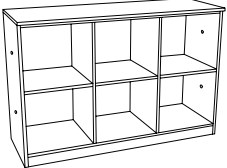
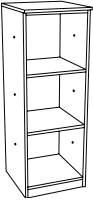
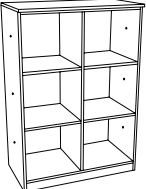
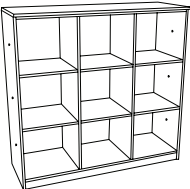
BLACK **E** | BOARDWALK **BW** | DRIFTWOOD **DW** | ESPRESSO **X** |
 GRAPHITE **GP** | MAHOGANY **M** | NATURAL MAPLE **FM** | SHORELINE **SL** |
 WINDSOR CHERRY **WC** |

				Zone Pricing	1	2	3			
2x2 Open Ottoman/Cubby Storage  <ul style="list-style-type: none"> • Four open ottoman/cubby storage areas • Two levels high • Prebored for adjustable shelves Freight Class: 125				H_2-2	37" X 20" X 37.5"	Cubic Ft: 19.4	Ship Weight: 95	1013	1028	1043
2x3 Open Ottoman/Cubby Storage  <ul style="list-style-type: none"> • Six open ottoman/cubby storage areas • Two levels high • Prebored for adjustable shelves Freight Class: 125				H_2-3	55" X 20" X 37.5"	Cubic Ft: 28.3	Ship Weight: 115	1250	1269	1288
3x1 Open Ottoman/Cubby Storage  <ul style="list-style-type: none"> • Three open ottoman/cubby storage areas • Three levels high • Prebored for adjustable shelves Freight Class: 125				H_3-1	19" X 20" X 53.75"	Cubic Ft: 14.7	Ship Weight: 75	814	826	838
3x2 Open Ottoman/Cubby Storage  <ul style="list-style-type: none"> • Six open ottoman/cubby storage areas • Three levels high • Prebored for adjustable shelves Freight Class: 125				H_3-2	37" X 20" X 53.75"	Cubic Ft: 27.3	Ship Weight: 135	1193	1211	1229
3x3 Open Ottoman/Cubby Storage  <ul style="list-style-type: none"> • Nine open ottoman/cubby storage areas • Three levels high • Prebored for adjustable shelves Freight Class: 125				H_3-3	55" X 20" X 53.75"	Cubic Ft: 39.9	Ship Weight: 195	1522	1545	1568
4x1 Open Ottoman/Cubby Storage  <ul style="list-style-type: none"> • Four open ottoman/cubby storage areas • Four levels high • Prebored for adjustable shelves Freight Class: 125				H_4-1	19" X 20" X 70"	Cubic Ft: 19.2	Ship Weight: 120	945	959	973

CONTEMPORARY LAMINATE

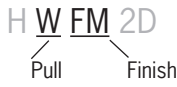

Zone Pricing	1	2	3
--------------	---	---	---

4x2 Open Ottoman/Cubby Storage



- Eight open ottoman/cubby storage areas
- Four level high
- Prebored for adjustable shelves

Freight Class: 125

H_4-2	37" X 20" X 70"	Cubic Ft: 35.7	Ship Weight: 200	1586	1610	1634
--------------	-----------------	----------------	------------------	-------------	-------------	-------------

Lockers

Single Locker Storage

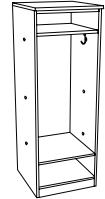

- Single locker storage with 2 coat hooks
- One shelf in the bottom and one shelf in the top

Freight Class: 125

H_1L	19" X 20" X 53.75"	Cubic Ft: 10.4	Ship Weight: 95	741	752	763
-------------	--------------------	----------------	-----------------	------------	------------	------------

Double Locker Storage

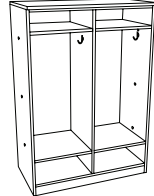

- Double locker storage with 2 coat hooks
- One shelf in the bottom and one shelf in the top

Freight Class: 125

H_2L	37" X 20" X 53.75"	Cubic Ft: 19.4	Ship Weight: 175	1103	1120	1136
-------------	--------------------	----------------	------------------	-------------	-------------	-------------

Triple Locker Storage

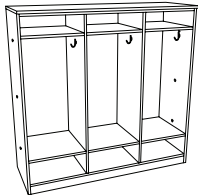

- Triple locker storage with 2 coat hooks
- One shelf in the bottom and one shelf in the top

Freight Class: 125

H_3L	55" X 20" X 53.75"	Cubic Ft: 28.3	Ship Weight: 255	1385	1406	1427
-------------	--------------------	----------------	------------------	-------------	-------------	-------------

Doors

Single Height Door

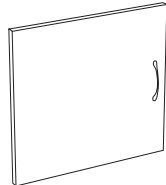

- Single-height door for cubby storage unit
- Includes pull and hinges for left/right application

Freight Class: 70

H_1D	18.5" X .75" X 18.25"	Cubic Ft: 0.7	Ship Weight: 8	137	139	141
-------------	-----------------------	---------------	----------------	------------	------------	------------

Double Height Door





- Double-height door for cubby storage unit
- Includes pull and hinges for left/right application

Freight Class: 70

H_2D	18.5" X .75" X 36.5"	Cubic Ft: 1.3	Ship Weight: 14	162	164	167
-------------	----------------------	---------------	-----------------	------------	------------	------------

FINISH SELECTION

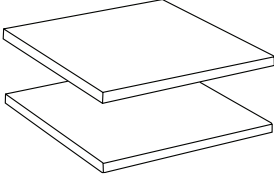
BLACK **E** | BOARDWALK **BW** | DRIFTWOOD **DW** | ESPRESSO **X** |
 GRAPHITE **GP** | MAHOGANY **M** | NATURAL MAPLE **FM** | SHORELINE **SL** |
 WINDSOR CHERRY **WC** |

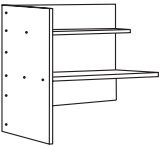
				Zone Pricing	1	2	3
Triple Height Door  Freight Class: 70 <ul style="list-style-type: none"> • Triple-height door for cubby storage unit • Includes pull and hinges for left/right application 				H_3D 18.5" X .75" X 48.75" Cubic Ft: 2.0 Ship Weight: 22	242	246	249
Shelves 2 Adjustable Shelves  Freight Class: 70 <ul style="list-style-type: none"> • Two adjustable shelves with pins • Fit all cubby storage units 				H_2S 17.125" X 18" X .75" Cubic Ft: 0.6 Ship Weight: 12	170	173	175
3-IN-1 Multicarrels Freestanding 3-IN-1 MultiCarrel  Freight Class: 100 <ul style="list-style-type: none"> • Worksurface: 34" W x 26" D • Shelf: 34" W x 11" D • 1" and 3/4" thermally fused laminate • AdvantEdge 3mm PVC edges • Leg levelers included • Assembly required 				UWSC_3630 36" X 30" X 48" Cubic Ft: 3.1 Ship Weight: 117	864	877	890
Add-On 3-IN-1 MultiCarrel  Freight Class: 100 <ul style="list-style-type: none"> • Same description as above except: • Connects with freestanding MultiCarrel 				UWSC_3630A 35" X 30" X 48" Cubic Ft: 3.1 Ship Weight: 89	714	725	735

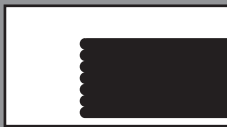

CHARACTERISTICS

Atlas modular casegoods offer extensive choice for design flexibility, adapting to various building layouts, business structures and personal work requirements. The details below will help you understand the key components of Atlas.

FINISH OPTIONS

– ALL COLORS ARE THE SAME PRICE –

Top/Base Colors

FM Natural Maple **WC** Windsor Cherry
M Mahogany

Base-Only Colors

BW Boardwalk **GP** Graphite
DW Driftwood **SL** Shoreline
E Black **X** Espresso

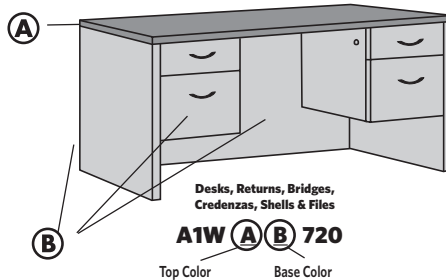

Desks, Returns, Bridges,
Credenzas, Shells & Files

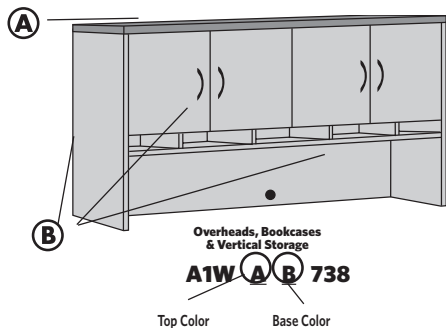

Overheads, Bookcases
& Vertical Storage

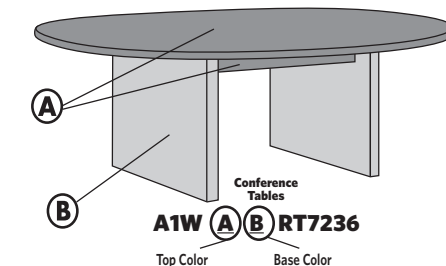

Conference
Tables

PEDESTALS & FILE CABINETS

All cases are $\frac{3}{4}$ " thick core with thermally fused laminate on both sides and full 3 millimeter PVC AdvantEdge banding. Full modesty panels. Full or $\frac{3}{4}$ height pedestals. Units fully assembled with dowels, glue, metal brackets and screws.

Pedestal Option

All units with pedestals available with full-to-floor or $\frac{3}{4}$ height pedestals.

PULL OPTIONS

Drawer/door pulls all constructed of solid metal. When ordering, use the corresponding pull designator at the beginning of the model number.

A1W Brushed Chrome **A1D** Oval Nickel
A1E Ebony **A1V** T-Bar Nickel
A1B Bright Brass

TOPS

All tops are $1\frac{1}{2}$ " thick with thermally fused laminate surface, proper backing and 3 millimeter PVC AdvantEdge banding as required. Tops have reeded edge on front and back of all units except bridges and returns which have reed edges on working side only. All bridge and return tops feature common grain direction with connecting units.

PANELS

End panels are 1" thick core with thermally fused laminate on both sides and full 3 millimeter PVC AdvantEdge banding as required. Full modesty panels are $\frac{3}{4}$ " thick core with thermally fused laminate on both sides and full 3 millimeter PVC AdvantEdge banding as required. Heavy-duty adjustable nylon leveling glides in 5" steel plate.

DRAWERS

All drawer fronts are constructed of $\frac{3}{4}$ " thick core with thermally fused laminate on both sides and full 3 millimeter PVC AdvantEdge banding as required. Drawer sides are $\frac{1}{2}$ " thick vinyl wrap with oak grain pattern. Drawer bottoms are $1/8$ " thick hardboard with oak grain pattern.

- All drawers suspended on smooth-action steel, ball-bearing slides
- File and lateral file drawers mounted on heavy-duty, ball-bearing, full-extension slides
- All file and lateral file drawers constructed for suspended filing with 25 lb maximum weight for bottom-loading
- Drawers constructed with 5 sides for extra strength and durability. Drawer front is the fifth side and is removable for field-repair or hardware additions

FILING

All file drawers include pre-installed, black filing hardware, easily reconfigured by user to adapt to specific requirements.

- Black filing hardware includes pre-installed rails with easy-adjust crossbar
- All file drawers accommodate letter-size filing front-to-back and letter- or legal-size filing side-to-side
- All lateral file drawers accommodate letter or legal-size filing side-to-side and letter or legal-size filing front-to-back

WIRE MANAGEMENT

See features for number of grommets and location. Additional 2.5" grommets can be added for extended wire management capability at \$106 list per grommet. Includes factory cut and installed grommet and black sleeve. Specify location with order.

LOCKS

- Desk/credenza pedestals feature single-key side locking, keyed alike
- Two drawer lateral file features single-key front locking and counter weight
- Four-drawer lateral file features central locking and anti-tilt mechanism
- Two and four-drawer lateral files keyed alike
- All other locks are keyed identical unless otherwise specified
- 'Key Different' option is \$21 list upcharge per lock. Locks/cores packaged to customer requirements
- Additional lead time for 'Key Different'
- For optional locking on overhead storage units add Y to the end of the model number and add \$150 to the list price of units with four doors or two doors not adjoining. Add \$75 for units with two adjoining doors

ACCESSORIES Factory Installed

Certain accessories can be ordered installed prior to shipment. Add letter designator (C or K) at end of the desk or credenza model number:

- C** Center Drawer
Example: A1WWC720C
- K** Keyboard Platform
Example: A1WWC704K
- T** Task Light
Example: A1WWC737T

QUICKSHIP

Quick Ship is not available on any items ordered with options.

PACKING

All units are properly packed in heavy-duty cartons, protected with extra-thick corner pads, and foam-wrapped for additional security. All packaging conforms to or exceeds specifications as outlined in the Uniform Freight Classification.

All desks, credenzas, files and overhead storage units are shipped set up. Modular L, U, and reception stations are shipped in multiple cartons and require field connection.

PALLETIZATION

See page 5.

CARE AND CLEANING INSTRUCTIONS

Normal cleaning: Clean using a soft cloth and a good window cleaner which contains no ammonia, followed by wiping dry using a dry soft cloth.

Specifications subject to change without notice.

Configurations

Zone Pricing	1	2	3
--------------	---	---	---

U Unit with Peninsula Desk & Maximum Kneespace

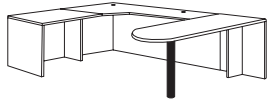

72" x 108"

Description	Model Number	Qty	Frnt.Class	Cubic Ft.	Ship Weight				
Peninsula Desk	A1_799 72" x 36" x 29.5"	1	250	51.6	187	1041	1057	1072	
Left Extended Corner Return	A1_450L 72" x 36/24" x 29.5"	1	200	52.4	218	1224	1242	1261	
Rectangular Shell-Full Left Leg	A1_RS2436L 36" x 24" x 29.5"	1	110	19.1	118	630	639	649	
Total:					123.10	523	2895	2938	2982

L Unit with Computer Corner Desk

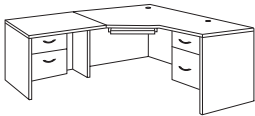

72" x 72"

Description	Model Number	Qty	Frnt.Class	Cubic Ft.	Ship Weight				
Right Pedestal Computer Corner Desk	A1_451R 72" x 36/24" x 29.5"	1	110	52.4	289	2052	2083	2114	
Left Pedestal Compact Return	A1_452L 36" x 24" x 29.5"	1	110	21.8	145	1029	1044	1060	
Total:					74.20	434	3081	3127	3174

Executive U Unit

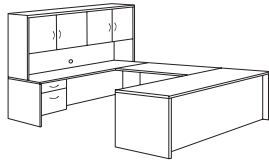

72" x 108" x 66.5"

Description	Model Number	Qty	Frnt.Class	Cubic Ft.	Ship Weight				
Right Pedestal Desk	A1_721R 72" x 36" x 29.5"	1	200	52.4	277	1527	1550	1573	
Left Pedestal Credenza	A1_725L 72" x 24" x 29.5"	1	125	36.3	202	1370	1391	1411	
Bridge	A1_485 48" x 24" x 29.5"	1	100	4.6	78	536	544	552	
Overhead Storage Unit with Doors	A1_737 72" x 16" x 37"	1	125	33.6	233	1479	1501	1523	
Task Light	TL2P 19.5" x 3.25" x 1.25"	1	200	1.0	3	124	126	128	
Total:					127.90	793	5036	5112	5187

Executive Office with Extra Storage



144" x 108" x 66.5"

Description	Model Number	Qty	Frnt.Class	Cubic Ft.	Ship Weight				
Double Pedestal Bow Front Desk	A1_720B 72" x 36" x 29.5"	1	110	52.4	307	1882	1910	1938	
Computer Credenza	A1_744 72" x 24" x 29.5"	1	110	36.3	293	1596	1620	1644	
Overhead Storage Unit with Doors	A1_737 72" x 16" x 37"	1	125	33.6	233	1479	1501	1523	
Storage Cabinet with Lateral File	A1_65STOR 36" x 24" x 66.5"	1	125	43.1	309	2197	2230	2263	
Five Shelf Bookcase	A1_65 36" x 16" x 66.5"	1	125	28.9	212	1024	1039	1055	
Total:					194.30	1354	8178	8300	8423

Executive U Unit with Curved Corner Desk

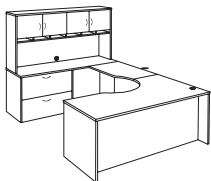

72" x 108" x 66.5"

Description	Model Number	Qty	Frnt.Class	Cubic Ft.	Ship Weight				
Right Pedestal Curved Corner Desk	A1_462R 72" x 42/30" x 29.5"	1	200	60.5	331	2080	2111	2142	
Asymmetrical Bridge	A1_495L 42" x 24" x 29.5"	1	125	4.6	67	656	666	676	
Left Lateral File Credenza	A1_733L 72" x 24" x 29.5"	1	125	36.3	261	1766	1792	1819	
Overhead Storage Unit with Doors and Paper Storage Shelves	A1_738 72" x 16" x 37"	1	125	33.6	252	1863	1891	1919	
Total:					135.00	911	6365	6460	6556

UNIT	KNEESPACE	OVERHANG
72" Double Pedestal Desk	38-1/4"	11"
66" Double Pedestal Desk	32-1/4"	5"
60" Double Pedestal Desk	26-1/4"	5"

UNIT	KNEESPACE	OVERHANG
72" Double Pedestal Credenza	38-1/4"	n/a
66" Double Pedestal Credenza	32-1/4"	n/a
72" Curved Corner Desk	n/a	5"

CONTEMPORARY LAMINATE



Zone Pricing	1	2	3
--------------	---	---	---

Cluster Work Station (4 People)



Description	Model Number	Qty	Frnt.Class	Cubic Ft.	Ship Weight				
Left Pedestal Computer Corner Desk	A1_451L 72" x 36/24" x 29.5"	4	110	52.4	289	2052	2083	2114	
Right Pedestal Compact Return	A1_452R 36" x 24" x 29.5"	4	110	21.8	145	1029	1044	1060	
Open Overhead Storage Unit	A1_717 72" x 16" x 37"	4	125	33.6	193	1185	1203	1221	
Group Total:					431.2	2108	17064	17320	17580

144" x 144" x 66.5"

MultiStation with Privacy (2 People)



Description	Model Number	Qty	Frnt.Class	Cubic Ft.	Ship Weight				
Left Pedestal Computer Corner Desk	A1_451L 72" x 36/24" x 29.5"	2	110	52.4	289	2052	2083	2114	
Right Pedestal Compact Return	A1_452R 36" x 24" x 29.5"	2	110	21.8	145	1029	1044	1060	
Open Overhead Storage Unit	A1_717 72" x 16" x 37"	2	125	33.6	193	1185	1203	1221	
Group Total:					215.6	1254	8532	8660	8790

177" x 72" x 66.5"

Double Workstation (2 People)



Description	Model Number	Qty	Frnt.Class	Cubic Ft.	Ship Weight				
Left Pedestal Credenza	A1_725L 72" x 24" x 29.5"	1	125	36.3	202	1370	1391	1411	
Right Pedestal Credenza	A1_725R 72" x 24" x 29.5"	1	125	36.3	202	1370	1391	1411	
Bridge	A1_485 48" x 24" x 29.5"	2	100	4.6	78	536	544	552	
Peninsula Desk	A1_799 72" x 36" x 29.5"	1	250	51.6	187	1041	1057	1072	
Overhead Storage Unit with Doors	A1_737 72" x 16" x 37"	2	125	33.6	233	1479	1501	1523	
Open Overhead Storage	A1_317 36" x 16" x 37"	1	125	15.3	111	608	617	626	
Group Total:					215.9	1324	8419	8546	8670

180" x 72" x 66.5"

Reception Station

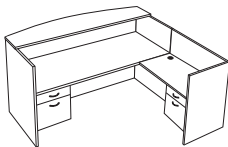

Description	Model Number	Qty	Frnt.Class	Cubic Ft.	Ship Weight				
Left Pedestal Reception Desk	A1_7230L 72" x 36" x 42.5"	1	110	64.4	373	1971	2001	2030	
Right Pedestal Reception Return	A1_2442R 42" x 24" x 41"	1	110	32.9	205	1308	1328	1347	
Total:					97.30	578	3279	3329	3377

72" x 78" x 42.5"

DESKS

Double Pedestal Bow Front Desk

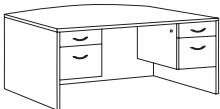

- Bow front top
- Box/File pedestals
- Pre-installed PROfile filing hardware
- Legal or letter filing
- Individual locking pedestals

Freight Class: 110

A1_720B QS	72" X 36" X 29.5"	Cubic Ft: 52.4	Ship Weight: 307	1882	1910	1938	
				Center Drawer C	177	180	182
				Keyboard Platform K	203	206	209

Pulls: Bright Brass **A1B** | Brushed Chrome **A1W** | Ebony **A1E** | Oval Nickel **A1D** | T-Bar Nickel **A1V**

QS FINISHES **FMGP** **WC** **QS PULLS** **W**

Double Full Pedestal Bow Front Desk



- Bow front top
- File/File left pedestal
- Box/Box/File right pedestal
- Pre-installed black filing hardware
- Legal or letter filing
- Individual locking pedestals

Freight Class: 110

A1_720BF2BF	72" X 36" X 29.5"	Cubic Ft: 52.4	Ship Weight: 321	2509	2547	2584	
				Center Drawer C	177	180	182
				Keyboard Platform K	203	206	209

Pulls: Bright Brass **A1B** | Brushed Chrome **A1W** | Ebony **A1E** | Oval Nickel **A1D** | T-Bar Nickel **A1V**

Double Pedestal Desk

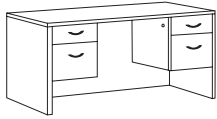

- Box/File pedestals
- Pre-installed, black filing hardware
- Legal or letter filing
- Individually side locking pedestals

Freight Class: 110

		Zone Pricing	1	2	3
A1_720	72" X 36" X 29.5" Cubic Ft: 52.4 Ship Weight: 316	1706	1732	1757	
	Center Drawer C	177	180	182	
	Keyboard Platform K	203	206	209	
A1_700	72" X 30" X 29.5" Cubic Ft: 45.1 Ship Weight: 284	1597	1621	1645	
	Center Drawer C	177	180	182	
	Keyboard Platform K	203	206	209	
A1_660	66" X 30" X 29.5" Cubic Ft: 41 Ship Weight: 270	1596	1620	1644	
	Center Drawer C	177	180	182	
	Keyboard Platform K	203	206	209	
A1_600	60" X 30" X 29.5" Cubic Ft: 37.2 Ship Weight: 254	1514	1537	1559	
	Center Drawer C	165	167	170	
	Keyboard Platform K	196	199	202	
Pulls: Bright Brass A1B Brushed Chrome A1W Ebony A1E Oval Nickel A1D T-Bar Nickel A1V					

Double Full Pedestal Desk

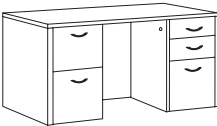

- File/File left pedestal
- Box/Box/File right pedestal
- Pre-installed, black filing hardware
- Legal or letter filing
- Individually side locking pedestals

Freight Class: 110

A1_720F2BF	72" X 36" X 29.5" Cubic Ft: 52.4 Ship Weight: 357	2205	2238	2271	
	Center Drawer C	177	180	182	
	Keyboard Platform K	203	206	209	
A1_700F2BF	72" X 30" X 29.5" Cubic Ft: 45.1 Ship Weight: 320	2076	2107	2138	
	Center Drawer C	177	180	182	
	Keyboard Platform K	203	206	209	
A1_660F2BF	66" X 30" X 29.5" Cubic Ft: 41 Ship Weight: 320	2050	2081	2112	
	Center Drawer C	177	180	182	
	Keyboard Platform K	203	206	209	
A1_600F2BF	60" X 30" X 29.5" Cubic Ft: 37.2 Ship Weight: 303	2021	2051	2082	
	Center Drawer C	165	167	170	
	Keyboard Platform K	196	199	202	
Pulls: Bright Brass A1B Brushed Chrome A1W Ebony A1E Oval Nickel A1D T-Bar Nickel A1V					

Left Pedestal Bow Front Desk



- Bow front top
- Box/File left pedestal
- Pre-installed, black filing hardware
- Legal or letter filing
- Side locking pedestal

Freight Class: 200

A1_721LB QS	72" X 36" X 29.5" Cubic Ft: 52.4 Ship Weight: 270	1688	1713	1739	
	Center Drawer C	165	167	170	
	Keyboard Platform K	196	199	202	
Pulls: Bright Brass A1B Brushed Chrome A1W Ebony A1E Oval Nickel A1D T-Bar Nickel A1V					
QS FINISHES FMGP WC QS PULLS W					

Right Pedestal Bow Front Desk

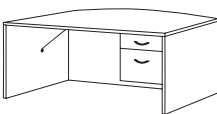

- Same description as above except:
- Box/File right pedestal

Freight Class: 200

A1_721RB QS	72" X 36" X 29.5" Cubic Ft: 52.4 Ship Weight: 270	1688	1713	1739	
	Center Drawer C	165	167	170	
	Keyboard Platform K	196	199	202	
Pulls: Bright Brass A1B Brushed Chrome A1W Ebony A1E Oval Nickel A1D T-Bar Nickel A1V					
QS FINISHES FMGP WC QS PULLS W					

Left Full Pedestal Bow Front Desk

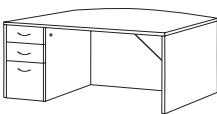

- Bow front top
- Box/Box/File left pedestal
- Pre-installed, black filing hardware
- Legal or letter filing
- Side locking pedestals

Freight Class: 110

A1_721LB2BF	72" X 36" X 29.5" Cubic Ft: 52.4 Ship Weight: 295	2017	2047	2078	
	Center Drawer C	165	167	170	
	Keyboard Platform K	196	199	202	
Pulls: Bright Brass A1B Brushed Chrome A1W Ebony A1E Oval Nickel A1D T-Bar Nickel A1V					

CONTEMPORARY LAMINATE

UNIT	KNEESPACE	OVERHANG
72" Double Pedestal Desk	38-1/4"	11"
66" Double Pedestal Desk	32-1/4"	5"
60" Double Pedestal Desk	26-1/4"	5"

UNIT	KNEESPACE	OVERHANG
72" Double Pedestal Credenza	38-1/4"	n/a
66" Double Pedestal Credenza	32-1/4"	n/a
72" Curved Corner Desk	n/a	5"



Zone Pricing	1	2	3
--------------	---	---	---

Right Full Pedestal Bow Front Desk

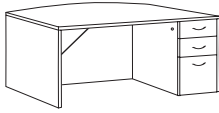

- Bow front top
- Box/Box/File right pedestal
- Pre-installed black filing hardware
- Legal or letter filing
- Side locking pedestal

Freight Class: 110

A1__721RB2BF 72" X 36" X 29.5" Cubic Ft: 52.4 Ship Weight: 295	2017	2047	2078
Center Drawer C	165	167	170
Keyboard Platform K	196	199	202

Pulls: Bright Brass **A1B** | Brushed Chrome **A1W** | Ebony **A1E** | Oval Nickel **A1D** | T-Bar Nickel **A1V**

Left Pedestal Desk

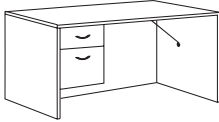

- Box/File left pedestal
- Pre-installed, black filing hardware
- Legal or letter filing
- Side locking pedestal

A1__721L 72" X 36" X 29.5" Cubic Ft: 52.4 Ship Weight: 277	1527	1550	1573
Freight Class: 200	Center Drawer C	165	167
	Keyboard Platform K	196	199

A1__700L 72" X 30" X 29.5" Cubic Ft: 45.1 Ship Weight: 250	1384	1405	1426
Freight Class: 110	Center Drawer C	165	167
	Keyboard Platform K	196	199

A1__651L 66" X 30" X 29.5" Cubic Ft: 41 Ship Weight: 239	1350	1370	1391
Freight Class: 110	Center Drawer C	165	167
	Keyboard Platform K	196	199

A1__641L 60" X 30" X 29.5" Cubic Ft: 37.2 Ship Weight: 218	1317	1337	1357
Freight Class: 110			

A1__431L 48" X 30" X 29.5" Cubic Ft: 31 Ship Weight: 194	1205	1223	1241
Freight Class: 110	Center Drawer C	165	167
	Keyboard Platform K	196	199

Pulls: Bright Brass **A1B** | Brushed Chrome **A1W** | Ebony **A1E** | Oval Nickel **A1D** | T-Bar Nickel **A1V**

Right Pedestal Desk

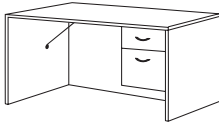

- Same description as above except:
- Box/File right pedestal

A1__721R 72" X 36" X 29.5" Cubic Ft: 52.4 Ship Weight: 277	1527	1550	1573
Freight Class: 200	Center Drawer C	165	167
	Keyboard Platform K	196	199

A1__700R 72" X 30" X 29.5" Cubic Ft: 45.1 Ship Weight: 250	1384	1405	1426
Freight Class: 110	Center Drawer C	165	167
	Keyboard Platform K	196	199

A1__651R 66" X 30" X 29.5" Cubic Ft: 41 Ship Weight: 239	1350	1370	1391
Freight Class: 110	Center Drawer C	165	167
	Keyboard Platform K	196	199

A1__641R 60" X 30" X 29.5" Cubic Ft: 37.2 Ship Weight: 218	1317	1337	1357
Freight Class: 110			

A1__431R 48" X 30" X 29.5" Cubic Ft: 31 Ship Weight: 194	1205	1223	1241
Freight Class: 110	Center Drawer C	165	167
	Keyboard Platform K	196	199

Pulls: Bright Brass **A1B** | Brushed Chrome **A1W** | Ebony **A1E** | Oval Nickel **A1D** | T-Bar Nickel **A1V**

Left Full Pedestal Desk

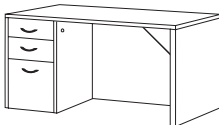

- Box/Box/File left pedestal
- Pre-installed, black filing hardware
- Legal or letter filing
- Side locking pedestal

A1__721L2BF 72" X 36" X 29.5" Cubic Ft: 52.4 Ship Weight: 302	1720	1746	1772
	Center Drawer C	165	167
	Keyboard Platform K	196	199

A1__700L2BF 72" X 30" X 29.5" Cubic Ft: 45.1 Ship Weight: 270	1673	1698	1723
	Center Drawer C	165	167
	Keyboard Platform K	196	199

A1__651L2BF 66" X 30" X 29.5" Cubic Ft: 41 Ship Weight: 264	1615	1639	1663
	Center Drawer C	165	167
	Keyboard Platform K	196	199

A1__641L2BF 60" X 30" X 29.5" Cubic Ft: 37.2 Ship Weight: 243	1409	1430	1451

A1__431L2BF 48" X 30" X 29.5" Cubic Ft: 31 Ship Weight: 219	1279	1298	1317
	Center Drawer C	165	167
	Keyboard Platform K	196	199

Pulls: Bright Brass **A1B** | Brushed Chrome **A1W** | Ebony **A1E** | Oval Nickel **A1D** | T-Bar Nickel **A1V**

Freight Class: 110

Zone Pricing	1	2	3
--------------	---	---	---

Right Full Pedestal Desk

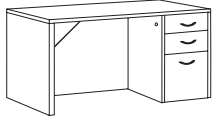

- Same description as above except:
- Box/Box/File right pedestal

Freight Class: 110

		1720	1746	1772
A1__721R2BF 72" X 36" X 29.5" Cubic Ft: 52.4 Ship Weight: 302				
	Center Drawer C	165	167	170
	Keyboard Platform K	196	199	202
A1__700R2BF 72" X 30" X 29.5" Cubic Ft: 45.1 Ship Weight: 270		1673	1698	1723
	Center Drawer C	165	167	170
	Keyboard Platform K	196	199	202
A1__651R2BF 66" X 30" X 29.5" Cubic Ft: 41 Ship Weight: 264		1615	1639	1663
	Center Drawer C	165	167	170
	Keyboard Platform K	196	199	202
A1__641R2BF 60" X 30" X 29.5" Cubic Ft: 37.2 Ship Weight: 243		1409	1430	1451
A1__431R2BF 48" X 30" X 29.5" Cubic Ft: 31 Ship Weight: 219		1279	1298	1317
	Center Drawer C	165	167	170
	Keyboard Platform K	196	199	202

Pulls: Bright Brass **A1B** | Brushed Chrome **A1W** | Ebony **A1E** | Oval Nickel **A1D** | T-Bar Nickel **A1V**

Corner Desks

Left Pedestal Computer Corner Desk



- Locking Box/File left pedestal
- Pre-installed black filing hardware
- Legal or letter filing
- Easy computer pullup
- Keyboard platform standard
- One grommet in top, one in modesty panel and one in support leg

Freight Class: 110

A1__451L 72" X 36/24" X 29.5" Cubic Ft: 52.4 Ship Weight: 289		2052	2083	2114
--	--	-------------	-------------	-------------

Pulls: Bright Brass **A1B** | Brushed Chrome **A1W** | Ebony **A1E** | Oval Nickel **A1D** | T-Bar Nickel **A1V**

Right Pedestal Computer Corner Desk

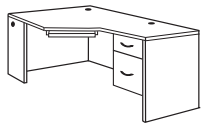

- Same description as above except:
- Locking Box/File right pedestal

Freight Class: 110

A1__451R 72" X 36/24" X 29.5" Cubic Ft: 52.4 Ship Weight: 289		2052	2083	2114
--	--	-------------	-------------	-------------

Pulls: Bright Brass **A1B** | Brushed Chrome **A1W** | Ebony **A1E** | Oval Nickel **A1D** | T-Bar Nickel **A1V**

Left Full Pedestal Computer Corner Desk



- Locking Box/Box/File left pedestal
- Pre-installed black filing hardware
- Legal or letter filing
- Easy computer pullup
- Keyboard platform standard
- One grommet in top, one in modesty panel and one in support leg

Freight Class: 110

A1__451L2BF 72" X 36/24" X 29.5" Cubic Ft: 52.4 Ship Weight: 314		2182	2215	2247
---	--	-------------	-------------	-------------

Pulls: Bright Brass **A1B** | Brushed Chrome **A1W** | Ebony **A1E** | Oval Nickel **A1D** | T-Bar Nickel **A1V**

Right Full Pedestal Computer Corner Desk



- Same description as above except:
- Locking Box/Box/File right pedestal

Freight Class: 110

A1__451R2BF 72" X 36/24" X 29.5" Cubic Ft: 52.4 Ship Weight: 314		2182	2215	2247
---	--	-------------	-------------	-------------

Pulls: Bright Brass **A1B** | Brushed Chrome **A1W** | Ebony **A1E** | Oval Nickel **A1D** | T-Bar Nickel **A1V**

Left Pedestal Curved Corner Desk

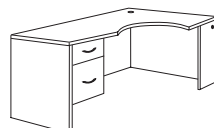

- Use with right asymmetrical bridge or shell with 19" connection
- Locking Box/File left pedestal
- Pre-installed black filing hardware
- Legal or letter filing
- Full access worksurface
- One grommet in top and one in support leg

Freight Class: 200

A1__462L 72" X 42-30" X 29.5" Cubic Ft: 60.5 Ship Weight: 331		2080	2111	2142
--	--	-------------	-------------	-------------

Pulls: Bright Brass **A1B** | Brushed Chrome **A1W** | Ebony **A1E** | Oval Nickel **A1D** | T-Bar Nickel **A1V**

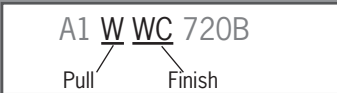
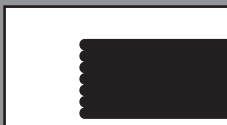

Zone Pricing	1	2	3
--------------	---	---	---

Right Pedestal Curved Corner Desk

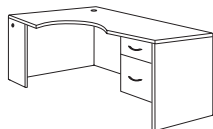

- Same description as above except:
- Locking Box/File right pedestal
- Use with left asymmetrical bridge or shell with 19" connection

Freight Class: 200

A1_462R 72" X 42-30" X 29.5" Cubic Ft: 60.5 Ship Weight: 331	2080	2111	2114
---	-------------	-------------	-------------

Pulls: Bright Brass A1B Brushed Chrome A1W Ebony A1E Oval Nickel A1D T-Bar Nickel A1V

Left Full Pedestal Curved Corner Desk



- Use with right asymmetrical bridge or shell with 19" connection
- Locking Box/Box/File left pedestal
- Pre-installed, black filing hardware
- Legal or letter filing
- Full-access worksurface

Freight Class: 110

A1_462L2BF 72" X 42-30" X 29.5" Cubic Ft: 60.5 Ship Weight: 356	2215	2248	2281
--	-------------	-------------	-------------

Pulls: Bright Brass A1B Brushed Chrome A1W Ebony A1E Oval Nickel A1D T-Bar Nickel A1V

Right Full Pedestal Curved Corner Desk



- Same description as above except:
- Locking Box/Box/File right pedestal
- Use with left asymmetrical bridge or shell with 19" connection

Freight Class: 110

A1_462R2BF 72" X 42-30" X 29.5" Cubic Ft: 60.5 Ship Weight: 356	2215	2248	2281
--	-------------	-------------	-------------

Pulls: Bright Brass A1B Brushed Chrome A1W Ebony A1E Oval Nickel A1D T-Bar Nickel A1V

Peninsula Desks

Peninsula Desk

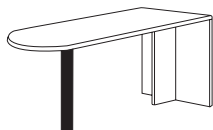

- Use with returns, bridges or rectangular shells
- Steel 4" diameter black cylinder base with leveling glide
- End support panel

Freight Class: 250

A1_799 72" X 36" X 29.5" Cubic Ft: 51.6 Ship Weight: 187	1041	1057	1072
---	-------------	-------------	-------------

Peninsula Desk with Modesty Panel

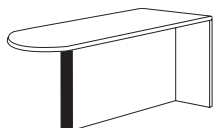

- Use with returns or bridges
- Steel 4" diameter black cylinder base with leveling glide
- End support panel

Freight Class: 250

A1_798 72" X 36" X 29.5" Cubic Ft: 51.6 Ship Weight: 211	1213	1231	1249
---	-------------	-------------	-------------

Peninsula Top and Column

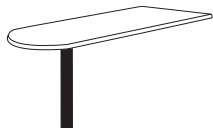

- Connect unsupported end to rectangular shell or credenza
- Steel 4" diameter black cylinder base with leveling glide
- Assembly required

Freight Class: 100

A1_797 72" X 36" X 29.5" Cubic Ft: 15.6 Ship Weight: 127	981	996	1010
---	------------	------------	-------------

Credenzas

Double Lateral File Credenza



- Four lateral file drawers
- Pre-installed, black filing hardware
- Legal or letter filing
- Front locking

Freight Class: 125

A1_733 72.5" X 24" X 29.5" Cubic Ft: 36.3 Ship Weight: 331	2232	2265	2299
---	-------------	-------------	-------------

Pulls: Bright Brass A1B Brushed Chrome A1W Ebony A1E Oval Nickel A1D T-Bar Nickel A1V

EXTRA THICK BOTTOM	\$320 H
---------------------------	----------------

Zone Pricing	1	2	3
--------------	---	---	---

Left Lateral File/Bookcase Credenza



- Two lateral file drawers on left
- Front locking lateral file
- Pre-installed, black filing hardware
- Legal or letter filing
- Bookcase with doors and adjustable shelf on right

Freight Class: 125

A1_BK733L	72.5" X 24" X 29.5"	Cubic Ft: 36.3	Ship Weight: 338	2120	2152	2184
------------------	---------------------	----------------	------------------	-------------	-------------	-------------

Pulls:	Bright Brass A1B	Brushed Chrome A1W	Ebony A1E	Oval Nickel A1D	T-Bar Nickel A1V
---------------	-------------------------	---------------------------	------------------	------------------------	-------------------------

EXTRA THICK BOTTOM	\$160 H
---------------------------	----------------

Right Lateral File/Bookcase Credenza

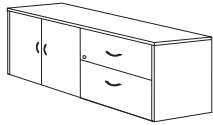

- Same description as above except:
- Lateral file on right
- Bookcase on left

Freight Class: 125

A1_BK733R	72.5" X 24" X 29.5"	Cubic Ft: 36.3	Ship Weight: 338	2120	2152	2184
------------------	---------------------	----------------	------------------	-------------	-------------	-------------

Pulls:	Bright Brass A1B	Brushed Chrome A1W	Ebony A1E	Oval Nickel A1D	T-Bar Nickel A1V
---------------	-------------------------	---------------------------	------------------	------------------------	-------------------------

EXTRA THICK BOTTOM	\$160 H
---------------------------	----------------

Double Bookcase Credenza

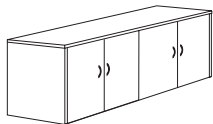

- Two bookcase compartments, each with one adjustable shelf
- Inside compartment dimensions: 34" x 21" x 25"

Freight Class: 125

A1_734	72.5" X 24" X 29.5"	Cubic Ft: 36.3	Ship Weight: 345	1754	1780	1807
---------------	---------------------	----------------	------------------	-------------	-------------	-------------

Pulls:	Bright Brass A1B	Brushed Chrome A1W	Ebony A1E	Oval Nickel A1D	T-Bar Nickel A1V
---------------	-------------------------	---------------------------	------------------	------------------------	-------------------------

Computer Credenza

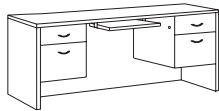

- Keyboard platform standard
- Box/File pedestals
- Pre-installed, black filing hardware
- Legal or letter filing
- Grommet in modesty panel
- Individually locking pedestals

Freight Class: 110

A1_744 QS	72" X 24" X 29.5"	Cubic Ft: 36.3	Ship Weight: 293	1596	1620	1644
------------------	-------------------	----------------	------------------	-------------	-------------	-------------

A1_644	66" X 24" X 29.5"	Cubic Ft: 33.4	Ship Weight: 266	1560	1583	1607
---------------	-------------------	----------------	------------------	-------------	-------------	-------------

Pulls:	Bright Brass A1B	Brushed Chrome A1W	Ebony A1E	Oval Nickel A1D	T-Bar Nickel A1V
---------------	-------------------------	---------------------------	------------------	------------------------	-------------------------

QS FINISHES	FMGP	WC	QS PULLS	W
--------------------	-------------	-----------	-----------------	----------

Full Pedestal Computer Credenza



- Same description as above except:
- File/File pedestals

Freight Class: 110

A1_744F	72" X 24" X 29.5"	Cubic Ft: 36.3	Ship Weight: 323	1903	1932	1960
----------------	-------------------	----------------	------------------	-------------	-------------	-------------

A1_644F	66" X 24" X 29.5"	Cubic Ft: 33.4	Ship Weight: 296	1851	1879	1907
----------------	-------------------	----------------	------------------	-------------	-------------	-------------

Pulls:	Bright Brass A1B	Brushed Chrome A1W	Ebony A1E	Oval Nickel A1D	T-Bar Nickel A1V
---------------	-------------------------	---------------------------	------------------	------------------------	-------------------------

Left Pedestal Credenza



- Box/File left pedestal
- Pre-installed, black filing hardware
- Legal or letter filing
- Side locking
- One wire management grommet in modesty panel
- Use 60" x 24" credenza with 42" x 19" bridge

Freight Class: 125

A1_725L	72" X 24" X 29.5"	Cubic Ft: 36.3	Ship Weight: 202	1370	1391	1411
----------------	-------------------	----------------	------------------	-------------	-------------	-------------

Center Drawer C	165	167	170
------------------------	-----	-----	-----

Keyboard Platform K	196	199	202
----------------------------	-----	-----	-----

A1_625L	66" X 24" X 29.5"	Cubic Ft: 33.4	Ship Weight: 190	1327	1347	1367
----------------	-------------------	----------------	------------------	-------------	-------------	-------------

Center Drawer C	165	167	170
------------------------	-----	-----	-----

Keyboard Platform K	196	199	202
----------------------------	-----	-----	-----

A1_615L	60" X 24" X 29.5"	Cubic Ft: 31	Ship Weight: 179	1291	1310	1330
----------------	-------------------	--------------	------------------	-------------	-------------	-------------

Pulls:	Bright Brass A1B	Brushed Chrome A1W	Ebony A1E	Oval Nickel A1D	T-Bar Nickel A1V
---------------	-------------------------	---------------------------	------------------	------------------------	-------------------------

Right Pedestal Credenza

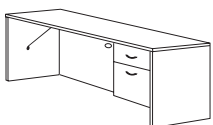

- Same description as above except:
- Box/File right pedestal

Freight Class: 125

A1_725R	72" X 24" X 29.5"	Cubic Ft: 36.3	Ship Weight: 202	1370	1391	1411
----------------	-------------------	----------------	------------------	-------------	-------------	-------------

Center Drawer C	165	167	170
------------------------	-----	-----	-----

Keyboard Platform K	196	199	202
----------------------------	-----	-----	-----

A1_625R	66" X 24" X 29.5"	Cubic Ft: 33.4	Ship Weight: 190	1327	1347	1367
----------------	-------------------	----------------	------------------	-------------	-------------	-------------

Center Drawer C	165	167	170
------------------------	-----	-----	-----

Keyboard Platform K	196	199	202
----------------------------	-----	-----	-----

A1_615R	60" X 24" X 29.5"	Cubic Ft: 31	Ship Weight: 179	1291	1310	1330
----------------	-------------------	--------------	------------------	-------------	-------------	-------------

Pulls:	Bright Brass A1B	Brushed Chrome A1W	Ebony A1E	Oval Nickel A1D	T-Bar Nickel A1V
---------------	-------------------------	---------------------------	------------------	------------------------	-------------------------

CONTEMPORARY LAMINATE



A1 **W** WC 720B
 Pull Finish

Zone Pricing	1	2	3
--------------	---	---	---

Left Full Pedestal Credenza



- File/File left pedestal
- Pre-installed, black filing hardware
- Legal or letter filing
- Side locking
- One wire management grommet in modesty panel

Freight Class: 125

A1__725LF 72" X 24" X 29.5" Cubic Ft: 36.3 Ship Weight: 217	1577	1601	1624
Center Drawer C	165	167	170
Keyboard Platform K	196	199	202
A1__625LF 66" X 24" X 29.5" Cubic Ft: 33.4 Ship Weight: 205	1559	1582	1606
Center Drawer C	165	167	170
Keyboard Platform K	196	199	202
A1__615LF 60" X 24" X 29.5" Cubic Ft: 31 Ship Weight: 194	1538	1561	1584
Pulls: Bright Brass A1B Brushed Chrome A1W Ebony A1E Oval Nickel A1D T-Bar Nickel A1V			

Right Full Pedestal Credenza



- Same description as above except:
- File/File right pedestal

Freight Class: 125

A1__725RF 72" X 24" X 29.5" Cubic Ft: 36.3 Ship Weight: 217	1577	1601	1624
Center Drawer C	165	167	170
Keyboard Platform K	196	199	202
A1__625RF 66" X 24" X 29.5" Cubic Ft: 33.4 Ship Weight: 205	1559	1582	1606
Center Drawer C	165	167	170
Keyboard Platform K	196	199	202
A1__615RF 60" X 24" X 29.5" Cubic Ft: 31 Ship Weight: 194	1538	1561	1584
Pulls: Bright Brass A1B Brushed Chrome A1W Ebony A1E Oval Nickel A1D T-Bar Nickel A1V			

Left Lateral File Credenza



- Two lateral file drawers on left
- Pre-installed, black filing hardware
- Legal or letter filing
- Front locking

Freight Class: 125

A1__733L QS 72" X 24" X 29.5" Cubic Ft: 36.3 Ship Weight: 261	1766	1792	1819
Pulls: Bright Brass A1B Brushed Chrome A1W Ebony A1E Oval Nickel A1D T-Bar Nickel A1V			
QS FINISHES FMGP WC QS PULLS W			
EXTRA THICK BOTTOM \$160 H			

Right Lateral File Credenza

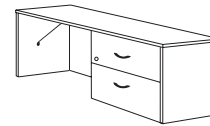

- Same description as above except:
- Two lateral file drawers on right

Freight Class: 125

A1__733R QS 72" X 24" X 29.5" Cubic Ft: 36.3 Ship Weight: 261	1766	1792	1819
Pulls: Bright Brass A1B Brushed Chrome A1W Ebony A1E Oval Nickel A1D T-Bar Nickel A1V			
QS FINISHES FMGP WC QS PULLS W			
EXTRA THICK BOTTOM \$160 H			

MultiFile Credenza

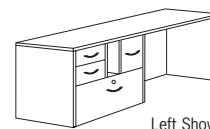

Left Shown

- One lateral file drawer with lock and extra thick drawer bottom
- One file drawer
- Pre-installed, black filing hardware
- Legal or letter filing
- Two box drawers
- HOT PROJECTS ACCESS SLOT

Freight Class: 125

A1__735L 72" X 24" X 29.5" Cubic Ft: 36.3 Ship Weight: 286	1827	1854	1882
A1__735R 72" X 24" X 29.5" Cubic Ft: 36.3 Ship Weight: 286	1827	1854	1882
Pulls: Bright Brass A1B Brushed Chrome A1W Ebony A1E Oval Nickel A1D T-Bar Nickel A1V			

Returns & Bridges

Left MultiFile Return



- Lateral file drawer with lock and extra thick drawer bottom
- File drawer
- Pre-installed, black filing hardware
- Legal or letter filing
- Two box drawers
- HOT PROJECTS ACCESS SLOT
- Connects with single pedestal desks or credenzas
- One grommet in modesty panel

Freight Class: 110

A1__735LRT 72" X 24" X 29.5" Cubic Ft: 36.3 Ship Weight: 280	1827	1854	1882
Keyboard Platform K	196	199	202
Pulls: Bright Brass A1B Brushed Chrome A1W Ebony A1E Oval Nickel A1D T-Bar Nickel A1V			

CONTEMPORARY LAMINATE

TOP BASE FINISHES

MAHOGANY **M** | NATURAL MAPLE **FM** | WINDSOR CHERRY **WC** |

BASE ONLY FINISHES

BLACK **E** | BOARDWALK **BW** | DRIFTWOOD **DW** | ESPRESSO **X** | GRAPHITE **GP** | SHORELINE **SL** |

Right MultiFile Return

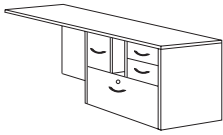

Freight Class: 110

- Lateral file drawer with lock and extra thick drawer bottom
- File drawer
- Pre-installed, black filing hardware
- Legal or letter filing
- Two box drawers
- HOT PROJECTS ACCESS SLOT
- Connects with single pedestal desks or credenzas
- One grommet in modesty panel

Zone Pricing	1	2	3
--------------	---	---	---

A1_735RRT 72" X 24" X 29.5" Cubic Ft: 36.3 Ship Weight: 280	1827	1854	1882
Keyboard Platform K	196	199	202

Pulls: Bright Brass **A1B** | Brushed Chrome **A1W** | Ebony **A1E** | Oval Nickel **A1D** | T-Bar Nickel **A1V**

Left Pedestal Desk Height Return

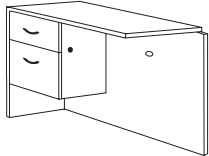

Freight Class: 110

- Box/File left pedestal
- Pre-installed, black filing hardware
- Legal or letter filing
- Side locking
- Wire management grommet in modesty

A1_722L 48" X 24" X 29.5" Cubic Ft: 24.7 Ship Weight: 166	1082	1098	1114
Keyboard Platform K	196	199	202

A1_622L 42" X 24" X 29.5" Cubic Ft: 21.8 Ship Weight: 156	1031	1046	1062
Keyboard Platform K	196	199	202

A1_452L 36" X 24" X 29.5" Cubic Ft: 21.8 Ship Weight: 145	1029	1044	1060
--	-------------	-------------	-------------

Pulls: Bright Brass **A1B** | Brushed Chrome **A1W** | Ebony **A1E** | Oval Nickel **A1D** | T-Bar Nickel **A1V**

Right Pedestal Desk Height Return

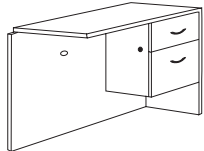

Freight Class: 110

- Same description as above except:
- Box/File right pedestal

A1_722R 48" X 24" X 29.5" Cubic Ft: 24.7 Ship Weight: 166	1082	1098	1114
Keyboard Platform K	196	199	202

A1_622R 42" X 24" X 29.5" Cubic Ft: 21.8 Ship Weight: 156	1031	1046	1062
Keyboard Platform K	196	199	202

A1_452R 36" X 24" X 29.5" Cubic Ft: 21.8 Ship Weight: 145	1029	1044	1060
--	-------------	-------------	-------------

Pulls: Bright Brass **A1B** | Brushed Chrome **A1W** | Ebony **A1E** | Oval Nickel **A1D** | T-Bar Nickel **A1V**

Left Full Pedestal Desk Height Return

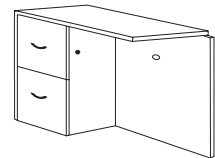

Freight Class: 110

- File/File left pedestal
- Pre-installed, black filing hardware
- Legal or letter filing
- Side locking
- Wire management grommet in modesty panel

A1_722LF 48" X 24" X 29.5" Cubic Ft: 24.7 Ship Weight: 182	1308	1328	1347
Keyboard Platform K	196	199	202

A1_622LF 42" X 24" X 29.5" Cubic Ft: 21.8 Ship Weight: 172	1289	1308	1328
Keyboard Platform K	196	199	202

A1_452LF 36" X 24" X 29.5" Cubic Ft: 21.8 Ship Weight: 161	1265	1284	1303
---	-------------	-------------	-------------

Pulls: Bright Brass **A1B** | Brushed Chrome **A1W** | Ebony **A1E** | Oval Nickel **A1D** | T-Bar Nickel **A1V**

Right Full Pedestal Desk Height Return

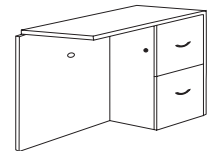

Freight Class: 110

- Same description as above except:
- File/File right pedestal

A1_722RF 48" X 24" X 29.5" Cubic Ft: 24.7 Ship Weight: 182	1308	1328	1347
Keyboard Platform K	196	199	202

A1_622RF 42" X 24" X 29.5" Cubic Ft: 21.8 Ship Weight: 172	1289	1308	1328
Keyboard Platform K	196	199	202

A1_452RF 36" X 24" X 29.5" Cubic Ft: 21.8 Ship Weight: 161	1265	1284	1303
---	-------------	-------------	-------------

Pulls: Bright Brass **A1B** | Brushed Chrome **A1W** | Ebony **A1E** | Oval Nickel **A1D** | T-Bar Nickel **A1V**

Desk Height Bridge

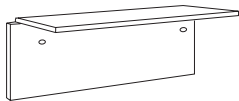

Freight Class: 100

- Use A1_384 with 60" desks to allow more kneespace
- Two wire management grommets in modesty panel
- Requires assembly of top to modesty panel

A1_485 QS 48" X 24" X 29.5" Cubic Ft: 4.6 Ship Weight: 78	536	544	552
A1_484 42" X 24" X 29.5" Cubic Ft: 4.6 Ship Weight: 69	483	490	497
A1_384 42" X 19" X 29.5" Cubic Ft: 4.6 Ship Weight: 57	490	497	505

QS FINISHES **FMGP** **WC**

CONTEMPORARY LAMINATE



Zone Pricing	1	2	3
--------------	---	---	---

Asymmetrical Shells & Bridges

Left Asymmetrical Bridge

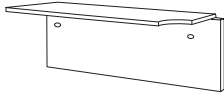

- Connects with right curved corner desk
- Connects at both ends; not freestanding
- Radius 19" deep right end
- Two grommets in modesty panel
- Assembly required

Freight Class: 100

A1_496L	48" X 24" X 29.5"	Cubic Ft: 4.6	Ship Weight: 78	672	682	692
A1_495L	42" X 24" X 29.5"	Cubic Ft: 4.6	Ship Weight: 67	656	666	676

Right Asymmetrical Bridge

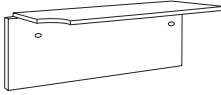

- Connects with left curved corner desk
- Connects at both ends; not freestanding
- Radius 19" deep left end
- Two grommets in modesty panel
- Requires assembly

Freight Class: 100

A1_496R	48" X 24" X 29.5"	Cubic Ft: 4.6	Ship Weight: 78	672	682	692
A1_495R	42" X 24" X 29.5"	Cubic Ft: 4.6	Ship Weight: 67	656	666	676

Corner Units

Corner Module with Curved Corner

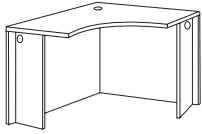

- Curved surface for easy pull up and full access to work area
- Freestanding with two half-legs
- Use 42" x 42" module with 30" deep asymmetrical shells (24" hookup) or 24" deep rectangular shells
- Use 36" x 36" module with 24" deep asymmetrical shells (19" hookup)
- One grommet in top, two in modesty and one in each support leg

Freight Class: 200

A1_449	42" X 42" X 29.5"	Cubic Ft: 34.3	Ship Weight: 172	925	939	953
24" Hook Up						
A1_448	36" X 36" X 29.5"	Cubic Ft: 27.7	Ship Weight: 135	821	833	846
19" Hook Up						

Corner Module with Straight Front

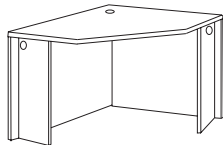

- Freestanding with two half legs
- Straight surface across front
- Easy computer pull up
- One grommet in top, two in modesty panel and one in each half leg
- 24" hookups

Freight Class: 200

A1_449S	42" X 42" X 29.5"	Cubic Ft: 34.3	Ship Weight: 173	925	939	953
24" Hook Up						

Shells 30" Deep

Freestanding 30" Deep Rectangular Shell

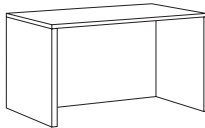

- Optional utility pedestals available
- Freestanding with two full legs

A1_RS3072	72" X 30" X 29.5"	Cubic Ft: 45.1	Ship Weight: 222	851	864	877
A1_RS3066	66" X 30" X 29.5"	Cubic Ft: 41	Ship Weight: 213	826	838	851
A1_RS3060	60" X 30" X 29.5"	Cubic Ft: 37.2	Ship Weight: 203	826	838	851
Freight Class: 200						
A1_RS3048	48" X 30" X 29.5"	Cubic Ft: 31	Ship Weight: 194	734	745	756
A1_RS3042	42" X 30" X 29.5"	Cubic Ft: 27	Ship Weight: 184	700	711	721
A1_RS3036	36" X 30" X 29.5"	Cubic Ft: 23.4	Ship Weight: 174	663	673	683
A1_RS3030	30" X 30" X 29.5"	Cubic Ft: 19.8	Ship Weight: 164	630	639	649
Freight Class: 110						

Shells 24" Deep

Zone Pricing	1	2	3
--------------	---	---	---

Freestanding 24" Deep Rectangular Shell

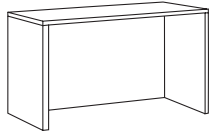

- Freestanding with two full legs
- Optional utility and mobile pedestals available

A1_RS2472	72" X 24" X 29.5"	Cubic Ft: 36.3	Ship Weight: 187	800	812	824
Freight Class: 200						
A1_RS2466	66" X 24" X 29.5"	Cubic Ft: 33.4	Ship Weight: 173	762	773	785
Freight Class: 200						
A1_RS2460	60" X 24" X 29.5"	Cubic Ft: 31.0	Ship Weight: 164	744	755	766
Freight Class: 200						
A1_RS2448	48" X 24" X 29.5"	Cubic Ft: 24.7	Ship Weight: 141	684	694	705
Freight Class: 110						
A1_RS2442	42" X 24" X 29.5"	Cubic Ft: 24.7	Ship Weight: 130	647	657	666
Freight Class: 110						
A1_RS2436	36" X 24" X 29.5"	Cubic Ft: 19.1	Ship Weight: 118	630	639	649
Freight Class: 110						
A1_RS2430	30" X 24" X 29.5"	Cubic Ft: 19.1	Ship Weight: 106	601	610	619
Freight Class: 110						

Left 24" Deep Rectangular Shell

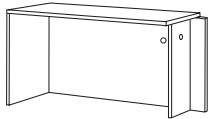

Support legs on 72", 66" and 60" lengths should be relocated inward (12" from either end) for increased worksurface support

- Connects with straight edge; not freestanding
- Full left, half right leg
- Grommet in half leg and modesty panel

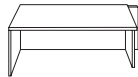

Support legs on 48", 42" and 36" and 30" lengths located close to ends

A1_RS2472L	72" X 24" X 29.5"	Cubic Ft: 36.3	Ship Weight: 187	800	812	824
Freight Class: 200						
A1_RS2466L	66" X 24" X 29.5"	Cubic Ft: 33.4	Ship Weight: 175	762	773	785
Freight Class: 200						
A1_RS2460L	60" X 24" X 29.5"	Cubic Ft: 31.0	Ship Weight: 164	744	755	766
Freight Class: 200						
A1_RS2448L	48" X 24" X 29.5"	Cubic Ft: 24.7	Ship Weight: 141	684	694	705
Freight Class: 110						
A1_RS2442L	42" X 24" X 29.5"	Cubic Ft: 24.7	Ship Weight: 130	647	657	666
Freight Class: 200						
A1_RS2436L	36" X 24" X 29.5"	Cubic Ft: 19.1	Ship Weight: 118	630	639	649
Freight Class: 110						
A1_RS2430L	30" X 24" X 29.5"	Cubic Ft: 19.1	Ship Weight: 106	601	610	619
Freight Class: 110						

Right 24" Deep Rectangular Shell

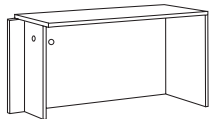

Support legs on 72", 66" and 60" lengths should be relocated inward (12" from either end) for increased worksurface support

- Connects with straight edge; not freestanding
- Full right, half left leg
- Grommet in half leg and modesty panel

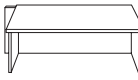

Support legs on 48", 42" and 36" and 30" lengths located close to ends

A1_RS2472R	72" X 24" X 29.5"	Cubic Ft: 36.3	Ship Weight: 187	800	812	824
Freight Class: 200						
A1_RS2466R	66" X 24" X 29.5"	Cubic Ft: 33.4	Ship Weight: 175	762	773	785
Freight Class: 200						
A1_RS2460R	60" X 24" X 29.5"	Cubic Ft: 31.0	Ship Weight: 164	744	755	766
Freight Class: 200						
A1_RS2448R	48" X 24" X 29.5"	Cubic Ft: 24.7	Ship Weight: 141	684	694	705
Freight Class: 110						
A1_RS2442R	42" X 24" X 29.5"	Cubic Ft: 24.7	Ship Weight: 130	647	657	666
Freight Class: 200						
A1_RS2436R	36" X 24" X 29.5"	Cubic Ft: 19.1	Ship Weight: 118	630	639	649
Freight Class: 110						
A1_RS2430R	30" X 24" X 29.5"	Cubic Ft: 19.1	Ship Weight: 106	601	610	619
Freight Class: 110						

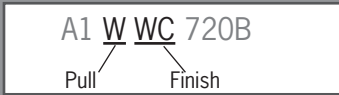

Zone Pricing	1	2	3
--------------	---	---	---

Modular Filing

Box/File Utility Pedestal



- 3/4 height pedestal for field installation inside shell
- Pre-installed, black filing hardware
- Legal or letter filing
- Single-key locking on front

Freight Class: 100

H_UP QS	15.75" X 22" X 17.75"	Cubic Ft: 7	Ship Weight: 61	660	670	680
----------------	-----------------------	-------------	-----------------	------------	------------	------------

Pulls:	Bright Brass HB	Brushed Chrome HW	Ebony HE	Oval Nickel HD	T-Bar Nickel HV
---------------	------------------------	--------------------------	-----------------	-----------------------	------------------------

QS FINISHES	FMGP	WC	QS PULLS	W
--------------------	-------------	-----------	-----------------	----------

Box/Box/File Utility Pedestal



- Full-to-floor pedestal for field installation inside shell
- Pre-installed, black filing hardware
- Legal or letter filing
- Single-key locking on front

Freight Class: 100

H_UP2BF	15.75" X 22" X 27.25"	Cubic Ft: 10.1	Ship Weight: 83	797	809	821
----------------	-----------------------	----------------	-----------------	------------	------------	------------

Pulls:	Bright Brass HB	Brushed Chrome HW	Ebony HE	Oval Nickel HD	T-Bar Nickel HV
---------------	------------------------	--------------------------	-----------------	-----------------------	------------------------

File/File Utility Pedestal



- Full-to-floor pedestal for field installation inside shell
- Pre-installed, black filing hardware
- Legal or letter filing
- Single-key locking on front

Freight Class: 100

H_UPF	15.75" X 22" X 27.25"	Cubic Ft: 10.1	Ship Weight: 83	797	809	821
--------------	-----------------------	----------------	-----------------	------------	------------	------------

Pulls:	Bright Brass HB	Brushed Chrome HW	Ebony HE	Oval Nickel HD	T-Bar Nickel HV
---------------	------------------------	--------------------------	-----------------	-----------------------	------------------------

Lateral Pedestal



- Full-to-floor pedestal for field installation inside shell
- Pre-installed, black filing hardware
- Legal or letter filing
- Single-key locking on front

Freight Class: 100

H_ULF	30.5" X 22" X 27.25"	Cubic Ft: 19.8	Ship Weight: 165	1001	1016	1031
--------------	----------------------	----------------	------------------	-------------	-------------	-------------

Pulls:	Bright Brass HB	Brushed Chrome HW	Ebony HE	Oval Nickel HD	T-Bar Nickel HV
---------------	------------------------	--------------------------	-----------------	-----------------------	------------------------

Reception Stations

Left Pedestal Reception Desk

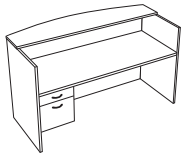

- 42" privacy height
- 18" Bow front transaction counter field installed
- Box/File left pedestal
- Pre-installed, black filing hardware
- Legal or letter filing
- Single-key side locking pedestal

Freight Class: 110

A1_7230L	72" X 36" X 42.5"	Cubic Ft: 64.4	Ship Weight: 373	1971	2001	2030
-----------------	-------------------	----------------	------------------	-------------	-------------	-------------

Center Drawer C	165	167	170
Keyboard Platform K	196	199	202

Pulls:	Bright Brass A1B	Brushed Chrome A1W	Ebony A1E	Oval Nickel A1D	T-Bar Nickel A1V
---------------	-------------------------	---------------------------	------------------	------------------------	-------------------------

Right Pedestal Reception Desk

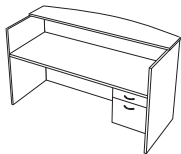

- Same description as above except:
- Box/File right pedestal

Freight Class: 110

A1_7230R	72" X 36" X 42.5"	Cubic Ft: 64.4	Ship Weight: 373	1971	2001	2030
-----------------	-------------------	----------------	------------------	-------------	-------------	-------------

Center Drawer C	165	167	170
Keyboard Platform K	196	199	202

Pulls:	Bright Brass A1B	Brushed Chrome A1W	Ebony A1E	Oval Nickel A1D	T-Bar Nickel A1V
---------------	-------------------------	---------------------------	------------------	------------------------	-------------------------

Zone Pricing	1	2	3
--------------	---	---	---

Left Pedestal Reception Return

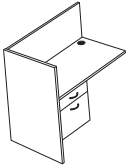

Freight Class: 110

- 41" privacy height
- Box/File left pedestal
- Pre-installed, black filing hardware
- Legal or letter filing
- Grommet in modesty panel
- Single-key side locking pedestal

A1_2442L 42" X 24" X 41" Cubic Ft: 32.9 Ship Weight: 205	1308	1328	1347
Keyboard Platform K	196	199	202

Pulls: Bright Brass **A1B** | Brushed Chrome **A1W** | Ebony **A1E** | Oval Nickel **A1D** | T-Bar Nickel **A1V**

Right Pedestal Reception Return

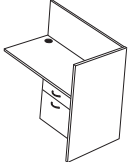

Freight Class: 110

- Same description as above except:
- Box/File left pedestal

A1_2442R 42" X 36" X 41" Cubic Ft: 32.9 Ship Weight: 205	1308	1328	1347
Keyboard Platform K	196	199	202

Pulls: Bright Brass **A1B** | Brushed Chrome **A1W** | Ebony **A1E** | Oval Nickel **A1D** | T-Bar Nickel **A1V**

Left Pedestal Reception Desk



Freight Class: 110

- 42" privacy height
- 18" Bow front transaction counter (field installed)
- Box/Box/File left pedestal
- Pre-installed, black filing hardware
- Legal or letter filing
- Single-key side locking pedestal

A1_7230L2BF 72" X 36" X 42.5" Cubic Ft: 64.4 Ship Weight: 398	2285	2319	2354
Center Drawer C	165	167	170
Keyboard Platform K	196	199	202

Pulls: Bright Brass **A1B** | Brushed Chrome **A1W** | Ebony **A1E** | Oval Nickel **A1D** | T-Bar Nickel **A1V**

Right Pedestal Reception Desk

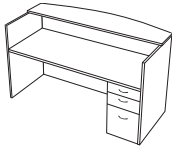

Freight Class: 110

- Same description as above except:
- Box/Box/File right pedestal

A1_7230R2BF 72" X 36" X 42.5" Cubic Ft: 64.4 Ship Weight: 398	2285	2319	2354
Center Drawer C	165	167	170
Keyboard Platform K	196	199	202

Pulls: Bright Brass **A1B** | Brushed Chrome **A1W** | Ebony **A1E** | Oval Nickel **A1D** | T-Bar Nickel **A1V**

Left Full Pedestal Reception Return



Freight Class: 110

- 41" privacy height
- File/File left pedestal
- Pre-installed, black filing hardware
- Legal or letter filing
- Grommet in top and modesty panel
- Single-key side locking pedestal

A1_2442LF 42" X 24" X 41" Cubic Ft: 32.9 Ship Weight: 230	1507	1530	1552
Keyboard Platform K	196	199	202

Pulls: Bright Brass **A1B** | Brushed Chrome **A1W** | Ebony **A1E** | Oval Nickel **A1D** | T-Bar Nickel **A1V**

Right Full Pedestal Reception Return

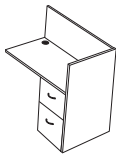

Freight Class: 110

- Same description as above except:
- File/File right pedestal

A1_2442RF 42" X 24" X 41" Cubic Ft: 32.9 Ship Weight: 230	1507	1530	1552
Keyboard Platform K	196	199	202

Pulls: Bright Brass **A1B** | Brushed Chrome **A1W** | Ebony **A1E** | Oval Nickel **A1D** | T-Bar Nickel **A1V**

Reception Screen for Main

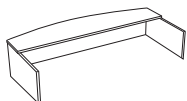

Freight Class: 70

- Fits 72" x 30" desks
- 18" Bow front transaction corner
- Non-skid rubber strips on bottom prohibit movement

A1_710 72" X 36" X 14.5" Cubic Ft: 28.9 Ship Weight: 145	1162	1179	1197
---	-------------	-------------	-------------



Zone Pricing	1	2	3
--------------	---	---	---

Reception Screen for Return



- Fits 42" x 24" executive height return
- Hardware included to join to main reception screen
- A1_611L fits left return
- A1_611R fits right return
- Assembly required

Freight Class: 70

A1_611L	42" X 24" X 13" Cubic Ft: 1.5 Ship Weight: 27	244	248	251
A1_611R	42" X 24" X 13" Cubic Ft: 1.5 Ship Weight: 27	244	248	251

Overhead Storage

Overhead Storage Unit

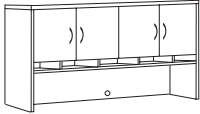

- Two storage compartments
- Four doors
- Five paper storage shelves, six shelves in A1_738
- 18.5" monitor clearance under cabinet
- Grommet in back panel

Freight Class: 125

A1_738 QS	72" X 16" X 37" Cubic Ft: 33.6 Ship Weight: 252	1863	1891	1919
Task Light T		124	126	128

A1_678	66" X 16" X 37" Cubic Ft: 28.3 Ship Weight: 226	1596	1620	1644
Task Light T		124	126	128

A1_676	60" X 16" X 37" Cubic Ft: 28.3 Ship Weight: 210	1577	1601	1624
Task Light T		124	126	128

Pulls: Bright Brass **A1B** Brushed Chrome **A1W** Ebony **A1E** Oval Nickel **A1D** T-Bar Nickel **A1V**

Locks: \$150_Y **QS FINISHES** **FMGP** **WC** **QS PULLS** **W**

Overhead Storage Unit

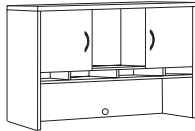

- Two storage compartments with doors
- Center open storage
- Four paper storage shelves
- 18.5" monitor clearance under cabinet
- Grommet in back panel

Freight Class: 125

A1_478	48" X 16" X 37" Cubic Ft: 24.3 Ship Weight: 191	1283	1302	1321
Task Light T		124	126	128

Pulls: Bright Brass **A1B** Brushed Chrome **A1W** Ebony **A1E** Oval Nickel **A1D** T-Bar Nickel **A1V**

Locks: \$150_Y

Overhead Storage Unit

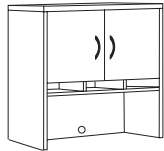

- One storage compartment
- Two doors
- Three paper storage shelves, four shelves in A1_476
- 18.5" monitor clearance under cabinet
- Grommet in back panel

Freight Class: 125

A1_456	42" X 16" X 37" Cubic Ft: 24.3 Ship Weight: 170	1202	1220	1238
Task Light T		124	126	128

A1_338	36" X 16" X 37" Cubic Ft: 15.3 Ship Weight: 151	1164	1181	1199
Task Light T		124	126	128

A1_336	30" X 16" X 37" Cubic Ft: 15.3 Ship Weight: 145	1102	1119	1135
Task Light T		124	126	128

Pulls: Bright Brass **A1B** Brushed Chrome **A1W** Ebony **A1E** Oval Nickel **A1D** T-Bar Nickel **A1V**

Locks: \$75_Y

Overhead Storage Unit

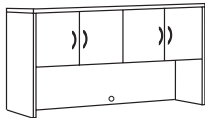

- Two storage compartments
- Four doors
- 21" monitor clearance under cabinet
- Grommet in back panel

Freight Class: 125

A1_737 QS	72" X 16" X 37" Cubic Ft: 33.6 Ship Weight: 233	1479	1501	1523
Task Light T		124	126	128

A1_677	66" X 16" X 37" Cubic Ft: 28.3 Ship Weight: 209	1213	1231	1249
Task Light T		124	126	128

A1_675	60" X 16" X 37" Cubic Ft: 28.3 Ship Weight: 190	1162	1179	1197
Task Light T		124	126	128

Pulls: Bright Brass **A1B** Brushed Chrome **A1W** Ebony **A1E** Oval Nickel **A1D** T-Bar Nickel **A1V**

Locks: \$150_Y **QS FINISHES** **FMGP** **WC** **QS PULLS** **W**

Zone Pricing	1	2	3
--------------	---	---	---

Overhead Storage Unit

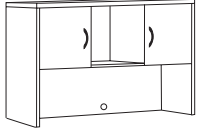

- Two storage compartments with doors
- Center open storage
- 21" monitor clearance under cabinet
- Grommet in back panel

Freight Class: 125

A1_477	48" X 16" X 37"	Cubic Ft: 24.3	Ship Weight: 171	942	956	970
Task Light I				124	126	128

Pulls: Bright Brass **A1B** | Brushed Chrome **A1W** | Ebony **A1E** | Oval Nickel **A1D** | T-Bar Nickel **A1V**

Locks: \$150_Y

Overhead Storage Unit

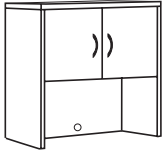

- One storage compartment
- Two doors
- 21" monitor clearance under cabinet
- Grommet in back panel

Freight Class: 125

A1_455	42" X 16" X 37"	Cubic Ft: 24.3	Ship Weight: 150	884	897	911
Task Light I				124	126	128

A1_337	36" X 16" X 37"	Cubic Ft: 28.3	Ship Weight: 131	821	833	846
Task Light I				124	126	128

A1_335	30" X 16" X 37"	Cubic Ft: 15.3	Ship Weight: 125	717	728	739
Task Light I				124	126	128

Pulls: Bright Brass **A1B** | Brushed Chrome **A1W** | Ebony **A1E** | Oval Nickel **A1D** | T-Bar Nickel **A1V**

Locks: \$75_Y

Open Overhead Storage Unit

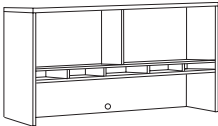

- Two cabinet compartments
- Five paper storage shelves, six shelves in A1_718
- 18.5" monitor clearance under cabinet
- Grommet in back panel

Freight Class: 125

A1_718	72" X 16" X 37"	Cubic Ft: 33.6	Ship Weight: 212	1675	1700	1725
Task Light I				124	126	128

A1_618	66" X 16" X 37"	Cubic Ft: 28.3	Ship Weight: 189	1261	1280	1299
Task Light I				124	126	128

A1_616	60" X 16" X 37"	Cubic Ft: 28.3	Ship Weight: 170	1232	1250	1269
Task Light I				124	126	128

Open Overhead Storage Unit

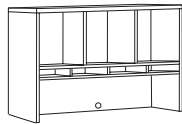

- Three cabinet compartments
- Four paper storage shelves
- 18.5" monitor clearance under cabinet
- Grommet in back panel

Freight Class: 125

A1_418	48" X 16" X 37"	Cubic Ft: 24.3	Ship Weight: 166	1076	1092	1108
Task Light I				124	126	128

Open Overhead Storage Unit

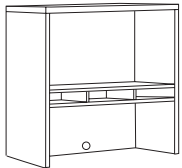

- One cabinet compartment
- Three paper storage shelves, four shelves in A1_416
- 18.5" monitor clearance under cabinet
- Grommet in back panel

Freight Class: 125

A1_416	42" X 16" X 37"	Cubic Ft: 24.3	Ship Weight: 147	996	1011	1026
Task Light I				124	126	128

A1_318	36" X 16" X 37"	Cubic Ft: 15.3	Ship Weight: 131	979	994	1008
Task Light I				124	126	128

A1_316	30" X 16" X 37"	Cubic Ft: 15.3	Ship Weight: 125	959	973	988
Task Light I				124	126	128

CONTEMPORARY LAMINATE



Open Overhead Storage Unit

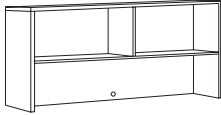

- Two cabinet compartments
- 21" monitor clearance under cabinet
- Grommet in back panel

Freight Class: 125

Open Overhead Storage Unit

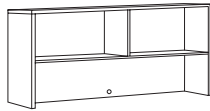

- Two cabinet compartments
- 21" monitor clearance under cabinet
- Grommet in back panel

Freight Class: 125

Open Overhead Storage Unit

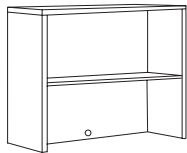

- Storage compartment
- 21" monitor clearance under cabinet
- Grommet in back panel

Freight Class: 125

Overhead Bookcase



- 2 adjustable 1" thick shelves
- Fits 36" lateral file, multfile or two-door storage cabinet

Freight Class: 125

Storage & Filing

Mobility Pedestal



- Fits under work surface
- Box/Box/File pedestal
- Pre-installed, black filing hardware
- Legal or letter filing
- Single-key front locking
- Four casters, two locking
- See additional on front mobile pedestals in Hyperwork section

Freight Class: 100

				Zone Pricing	1	2	3
A1_717	72" X 16" X 37"	Cubic Ft: 33.6	Ship Weight: 193	1185	1203	1221	
	Task Light T			124	126	128	
A1_617	66" X 16" X 37"	Cubic Ft: 28.3	Ship Weight: 169	849	862	874	
	Task Light T			124	126	128	
A1_615	60" X 16" X 37"	Cubic Ft: 28.3	Ship Weight: 150	805	817	829	
	Task Light T			124	126	128	
A1_417	48" X 16" X 37"	Cubic Ft: 24.3	Ship Weight: 146	744	755	766	
	Task Light T			124	126	128	
A1_415	42" X 16" X 37"	Cubic Ft: 24.3	Ship Weight: 130	648	658	667	
	Task Light T			124	126	128	
A1_317	36" X 16" X 37"	Cubic Ft: 15.3	Ship Weight: 111	608	617	626	
	Task Light T			124	126	128	
A1_315	30" X 16" X 37"	Cubic Ft: 15.3	Ship Weight: 105	536	544	552	
	Task Light T			124	126	128	
A1_319	36" X 16" X 37"	Cubic Ft: 15.3	Ship Weight: 125	817	829	842	

H_212BF	16" X 22.25" X 27.25"	Cubic Ft: 10.3	Ship Weight: 125	982	997	1011	
Pulls:	Bright Brass HB	Brushed Chrome HW	Ebony HE	Oval Nickel HD	T-Bar Nickel HV		

Zone Pricing	1	2	3
--------------	---	---	---

Two-Drawer Lateral File



- Two lateral file drawers, legal or letter filing
- Pre-installed black filing hardware
- Front locking
- Anti-tilt counterweight standard
- Hardwood bottom support rail secured with metal bracket at each end

Freight Class: 100

A1_346 QS	36.5" X 24" X 29.5" Cubic Ft: 19.8 Ship Weight: 194	1364	1384	1405
------------------	---	-------------	-------------	-------------

Pulls:	Bright Brass A1B	Brushed Chrome A1W	Ebony A1E	Oval Nickel A1D	T-Bar Nickel A1V
---------------	-------------------------	---------------------------	------------------	------------------------	-------------------------

EXTRA THICK BOTTOM	\$160 H
---------------------------	----------------

QS FINISHES	FMGP	WC	QS PULLS	W
--------------------	-------------	-----------	-----------------	----------

MultiFile

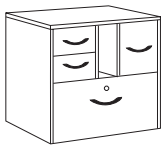

- Lateral file drawer with lock and extra thick drawer bottom
- File drawer
- Two box drawers
- Hot projects access slot
- Pre-installed black filing hardware
- Legal or letter filing

Freight Class: 125

A1_735	36.5" X 24" X 29.5" Cubic Ft: 19.8 Ship Weight: 205	1368	1389	1409
---------------	---	-------------	-------------	-------------

Pulls:	Bright Brass A1B	Brushed Chrome A1W	Ebony A1E	Oval Nickel A1D	T-Bar Nickel A1V
---------------	-------------------------	---------------------------	------------------	------------------------	-------------------------

Two-Door Storage Cabinet

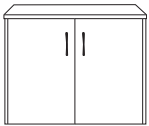

- Two hinged doors
- One adjustable shelf
- Leveling glides
- Inside dimensions: 34" x 21" x 24"

Freight Class: 125

A1_732	36.5" X 24" X 29.5" Cubic Ft: 19.8 Ship Weight: 141	1085	1101	1118
---------------	---	-------------	-------------	-------------

Pulls:	Bright Brass A1B	Brushed Chrome A1W	Ebony A1E	Oval Nickel A1D	T-Bar Nickel A1V
---------------	-------------------------	---------------------------	------------------	------------------------	-------------------------

Four-Drawer Lateral File



- Four lateral file drawers, legal or letter filing
- Pre-installed black filing hardware
- Central locking (lock on front)
- Anti-tilt mechanism prevents more than one drawer opening at a time
- Hardwood bottom support rail secured with metal bracket at each end

Freight Class: 100

A1_426	30.75" X 20.75" X 57.25" Cubic Ft: 27.9 Ship Weight: 259	2551	2589	2628
---------------	--	-------------	-------------	-------------

Pulls:	Bright Brass A1B	Brushed Chrome A1W	Ebony A1E	Oval Nickel A1D	T-Bar Nickel A1V
---------------	-------------------------	---------------------------	------------------	------------------------	-------------------------

EXTRA THICK BOTTOM	\$320 H
---------------------------	----------------

Three-Drawer Lateral File



- Three lateral file drawers, legal or letter filing
- Pre-installed black filing hardware
- Central locking (lock on front)
- Anti-tilt mechanism prevents more than one drawer opening at a time
- Hardwood bottom support rail secured with metal bracket at each end

Freight Class: 100

A1_3036	30.75" X 20.75" X 45" Cubic Ft: 21.7 Ship Weight: 202	1805	1832	1859
----------------	---	-------------	-------------	-------------

Pulls:	Bright Brass A1B	Brushed Chrome A1W	Ebony A1E	Oval Nickel A1D	T-Bar Nickel A1V
---------------	-------------------------	---------------------------	------------------	------------------------	-------------------------

EXTRA THICK BOTTOM	\$240 H
---------------------------	----------------

Storage Cabinet



- Storage compartment 34" x 19.625" x 34"
- Two adjustable shelves in storage compartment
- Two lateral file drawers, legal or letter filing
- Front-locking file cabinet
- Hardwood bottom support rail secured with metal bracket at each end

Freight Class: 125

A1_65STOR QS	36" X 24" X 66.5" Cubic Ft: 43.1 Ship Weight: 309	2197	2230	2263
---------------------	---	-------------	-------------	-------------

Pulls:	Bright Brass A1B	Brushed Chrome A1W	Ebony A1E	Oval Nickel A1D	T-Bar Nickel A1V
---------------	-------------------------	---------------------------	------------------	------------------------	-------------------------

EXTRA THICK BOTTOM	\$160 H
---------------------------	----------------

QS FINISHES	FMGP	WC	QS PULLS	W
--------------------	-------------	-----------	-----------------	----------

CONTEMPORARY LAMINATE

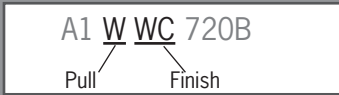

Zone Pricing	1	2	3
--------------	---	---	---

Wardrobe

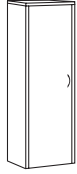

- Coat rod mounted side-to-side
- Adjustable shelf near bottom
- A1_65WDL - Hinge on left
- A1_65WDR - Hinge on right

Freight Class: 125

A1_65WDL	24" X 24" X 66.5"	Cubic Ft: 31.6	Ship Weight: 134	1747	1773	1799
A1_65WDR	24" X 24" X 66.5"	Cubic Ft: 31.6	Ship Weight: 134	1747	1773	1799
Pulls:	Bright Brass A1B	Brushed Chrome A1W	Ebony A1E	Oval Nickel A1D	T-Bar Nickel A1V	

Five Shelf Bookcase

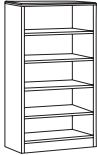

- 84" = 5 adjustable shelves
- 72" = 4 adjustable shelves
- 60" = 3 adjustable shelves
- Bottom shelf fixed
- All shelves 1" thick
- Back panel finished one side

Freight Class: 125

A1_84	36" X 12" X 84.5"	Cubic Ft: 28.6	Ship Weight: 182	1230	1248	1267
A1_72	36" X 12" X 72.5"	Cubic Ft: 24.7	Ship Weight: 154	1150	1167	1185
A1_60	36" X 12" X 60.5"	Cubic Ft: 20.7	Ship Weight: 125	1012	1027	1042

Three Shelf Bookcase



- Two adjustable shelves
- Bottom shelf fixed
- All shelves 1" thick and adjustable every 1.25"
- Back panel finished one side

Freight Class: 125

A1_48	36" X 12" X 48.5"	Cubic Ft: 16.8	Ship Weight: 107	740	751	762
A1_36	36" X 12" X 36.5"	Cubic Ft: 12.5	Ship Weight: 89	694	704	715

Five Shelf Bookcase

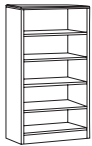

- Three adjustable shelves
- Bottom and second-from-bottom shelves fixed
- All shelves 1" thick
- Back panel 3/4" thick, finished both sides
- Shelves adjustable every 1.25"

Freight Class: 125

A1_65 QS	36" X 16" X 66.5"	Cubic Ft: 28.9	Ship Weight: 212	1024	1039	1055
QS FINISHES	FMGP	WC				

Bookcase with Doors

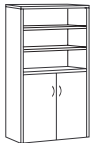

- Two door storage area
- One adjustable and one fixed shelf behind doors
- Two adjustable and one fixed shelf above doors
- 1" thick shelves
- Back panel 3/4" thick, finished both sides

Freight Class: 125

A1_652D	36" X 16" X 66.5"	Cubic Ft: 28.9	Ship Weight: 232	1382	1403	1423
Pulls:	Bright Brass A1B	Brushed Chrome A1W	Ebony A1E	Oval Nickel A1D	T-Bar Nickel A1V	

Curved Corner Bookcase, 66.5" High

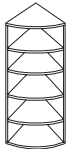

- Fits in corner at end of workstation
- Five shelf storage
- Four adjustable shelves
- Bottom shelf fixed
- 1" thick shelves
- AdvantEdge front edge

Freight Class: 125

A1_CB65	24" X 24" X 66.5"	Cubic Ft: 31.6	Ship Weight: 192	1248	1267	1285
----------------	-------------------	----------------	------------------	-------------	-------------	-------------

Curved Corner Bookcase, 29" High



- Fits in corner of workstation
- Middle shelf adjustable
- 1" thick shelves
- AdvantEdge front edge

Freight Class: 125

A1_CB29	24" X 24" X 29.5"	Cubic Ft: 20	Ship Weight: 123	1093	1109	1126
----------------	-------------------	--------------	------------------	-------------	-------------	-------------

Conference Room Accessories

Zone Pricing	1	2	3
--------------	---	---	---

Multiuse Wardrobe/Storage

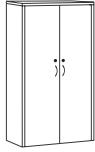

- Two-door storage area
- Coat rod mounted side-to-side on left
- Four adjustable shelves right
- Both sides drilled for adjustable shelves
- 3/4" thick shelves
- Individually locking doors

Freight Class: 125

A1_65DWD	36.5" X 24" X 66.5" Cubic Ft: 43.1 Ship Weight: 359	2276	2310	2344
-----------------	---	-------------	-------------	-------------

Pulls:	BRUSHED CHROME A1W	EBONY A1E	BRIGHT BRASS A1B	OVAL NICKEL A1D	T-BAR NICKEL A1V
---------------	---------------------------	------------------	-------------------------	------------------------	-------------------------

Two-Door Storage Cabinet

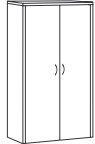

- Two-door storage cabinet
- Four full width adjustable shelves
- 1" thick shelves

Freight Class: 125

A1_65DS	36.5" X 24" X 66.5" Cubic Ft: 43.1 Ship Weight: 309	2156	2188	2221
----------------	---	-------------	-------------	-------------

Pulls:	BRUSHED CHROME A1W	EBONY A1E	BRIGHT BRASS A1B	OVAL NICKEL A1D	T-BAR NICKEL A1V
---------------	---------------------------	------------------	-------------------------	------------------------	-------------------------

Mobile Audio/Visual Cabinet



- Full-opening doors
- Upper/lower locks
- Up to 29", 150-lb. TV
- Pull out 360 degree swivel TV shelf
- Adjustable DVD shelf at top
- Two adjustable shelves in bottom
- Shelf & back grommets
- 400 lb. capacity
- Handhold for easy movement
- Casters for mobility

Freight Class: 125

A1_65AV	36.5" X 24" X 66.5" Cubic Ft: 43.1 Ship Weight: 309	3006	3051	3096
----------------	---	-------------	-------------	-------------

Pulls:	Bright Brass A1B	Brushed Chrome A1W	Ebony A1E	Oval Nickel A1D	T-Bar Nickel A1V
---------------	-------------------------	---------------------------	------------------	------------------------	-------------------------

Mobile Media Stand



- Three adjustable shelves
- Cords drop behind shelves
- Grommets in back for wire management
- Casters for mobility
- Hand hold for easy movement

Freight Class: 125

A1_MMS	24" X 24" X 66.5" Cubic Ft: 31.6 Ship Weight: 136	1511	1534	1556
---------------	---	-------------	-------------	-------------

Mobile Height-Adjustable Pie Shaped Table



- Pie-shaped top
- 10" pneumatic height adjustment for standing or sitting work area
- Five-star base with locking casters
- Freestanding

Freight Class: 125

A1_ET24	24" X 28" X 23.5-33.5" Cubic Ft: 16.7 Ship Weight: 46	1043	1059	1074
----------------	---	-------------	-------------	-------------

A1_ET30	30" X 35" X 23.5-33.5" Cubic Ft: 16.7 Ship Weight: 58	1096	1112	1129
----------------	---	-------------	-------------	-------------

Mobile Height-Adjustable Bullet Shape Table



- Bullet-shaped top
- 10" pneumatic height adjustment for standing or sitting work area
- Five-star base with locking casters
- Freestanding

Freight Class: 125

A1_MT24	28" X 24" X 23.5-33.5" Cubic Ft: 16.7 Ship Weight: 50	884	897	911
----------------	---	------------	------------	------------

A1_MT30	30" X 28" X 23.5-33.5" Cubic Ft: 16.7 Ship Weight: 66	968	983	997
----------------	---	------------	------------	------------

GENERAL

All cases are thermally fused laminate surfaced on the outside and edge banded as required

LAMINATE FINISH OPTIONS

All colors are the same price.
 All finishes are thermally fused laminates unless otherwise noted.

FINISHES - Available for all surfaces:

E	Black
BW	Boardwalk
DW	Driftwood
X	Espresso
GP	Graphite
M	Mahogany (Quick Ship)
FM	Natural Maple
SL	Shoreline
WC	Windsor Cherry

TACKBOARDS

Tackboards are available in any HPFi fabric. See web site for patterns and colors available.

TOPS

Utility, meeting and conference table tops are 1-1/8" thick, all other tops are 1" thick with thermally fused laminate surface, proper backing and full 3 millimeter PVC AdvantEdge banding.

PEDESTALS AND FILE CABINETS

All cases are thermally fused laminate surfaced on the outside and edge banded as required. Units fully assembled with dowels/glue, wood cleats, metal brackets and screws.

DRAWERS

All drawer fronts are thermally fused laminate surfaced on both sides with laminate and edge banded as required. Drawer sides and bottoms are printed with an oak grain pattern.

- All box drawers are suspended on smooth-action metal slides with ball bearings
- File cabinet drawers and file drawers are mounted on heavy-duty ball bearing, full-extension slides
- All file drawers are fitted for letter size filing front-to-back and legal size filing from side-to-side
- All file drawers are constructed for suspended filing
- Black filing hardware includes pre-installed rails with easy-adjust crossbar
- Maximum weight for bottom loading is 25 lbs
- Drawers are constructed with 5 sides for extra strength and durability. The drawer front is the 5th side and is removable in the field for repairs or hardware additions

CREDENZAS / HUTCHES

Doors operate on concealed hinges that permit 95° throw. Hutch placed over desk or credenza will be 62"H.

LEVELING GLIDES

All units fitted with leveling glides.

LOCKS

Front locks are included on all drawer and lateral file drawer pedestals. All locks are keyed identical.

For optional locking on overhead storage hutch add Y to the end of the model number and add \$75 per door to list price of unit.

PULLS

Vision features a European style 5-3/8" pull installed vertically on the surface facade. Metallic satin nickel finish. Pulls add 1-1/2" to depth of unit.

METAL LEGS

Table desks are equipped with 2" diameter brushed steel legs. Pedestal feet are 2" high and 1" diameter polished aluminum with levelers.

WIRE MANAGEMENT

See features for number of grommets and location. Additional round grommets with 1½" opening can be added for extended wire management capability at \$106 list per grommet. Includes factory cut and installed grommet and black sleeve. Must specify location.

PACKING

All units are properly packed in heavy duty cartons with heavy duty corner pads. All packaging conforms to or exceeds specifications as outlined in the Uniform Freight Classification.

All desks, credenzas, files, and overhead storage units are shipped set up. Modular L-shaped, and U-shaped workstations are shipped in multiple cartons and require connection in the field.

CARE AND MAINTENANCE

Dust only with a clean, dry cloth. Clean any marks with a damp cloth, using a small amount of mild soap or clean with a window cleaner which contains no ammonia, followed by wiping dry using a dry soft cloth. Do not use any furniture polish containing silicone. Excessive use of any polish can eventually cause a film build up and discolor the surfaces. Do not place furniture in a position of permanent exposure to direct sunlight.

Specifications subject to change without notice.

Configurations

Left L-Shape Station



Freight Class: 100

30" main surface and 20" return depth

MODEL NUMBER	FOOT PRINT	CUBIC FT	SHIP WEIGHT	Zone Pricing		
VC_72LL42	72"W X 72"D X 29"H	26	253	2122	2154	2186
VC_66LL42	66"W X 72"D X 29"H	25	246	2093	2124	2156
VC_60LL42	60"W X 72"D X 29"H	25	241	2063	2094	2125

24" main surface and 20" return depth

VC_72LL48	72"W X 72"D X 29"H	28	239	2041	2072	2102
VC_66LL48	66"W X 72"D X 29"H	27	234	2018	2048	2079
VC_60LL48	60"W X 72"D X 29"H	27	230	1993	2023	2053

- For front locking Box/box/file pedestal on left, please add suffix -3 after model number
- For front locking File/file pedestal on left side, please add suffix -2 after model number
- Metal post legs, 8" raised satin acrylic modesty panel on desk and full height side panels
- Pedestal is inset by 3"
- Table desk requires simple assembly using supplied hardware
- Return unit ships fully assembled

Left L-Shape Station with Integrated Hutch

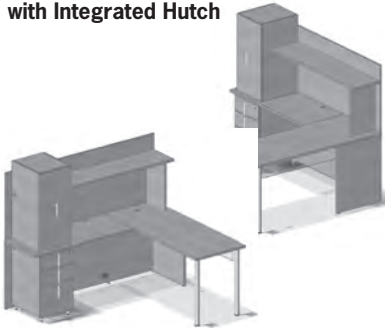

Freight Class: 125

30" main surface and 20" return depth

MODEL NUMBER	FOOT PRINT	CUBIC FT	SHIP WEIGHT	Zone Pricing		
VC_72LL42H	72"W X 72"D X 29/62"H	56	395	3159	3206	3254
VC_66LL42H	66"W X 72"D X 29/62"H	55	388	3118	3165	3212
VC_60LL42H	60"W X 72"D X 29/62"H	55	383	3073	3119	3165

24" main surface and 20" return depth

VC_72LL48H	72"W X 72"D X 29/62"H	58	381	3079	3125	3171
VC_66LL48H	66"W X 72"D X 29/62"H	57	371	3056	3102	3148
VC_60LL48H	60"W X 72"D X 29/62"H	57	361	3030	3075	3121

- For front locking Box/box/file pedestal on left, please add suffix -3 after model number
- For front locking File/file pedestal on left side, please add suffix -2 after model number
- Metal post legs, 8" raised satin acrylic modesty panel on desk and full height side panels
- Pedestal is inset by 3"
- Table desk requires simple assembly using supplied hardware
- Hutch and return ship fully assembled

Left Executive U-Shape Station



Freight Class: 100

48" X 20" bridge units

MODEL NUMBER	FOOT PRINT	CUBIC FT	SHIP WEIGHT	Zone Pricing		
VC_72UL48	72"W X 98"D X 29"H	41	350	2696	2736	2777
VC_66UL48	66"W X 98"D X 29"H	38	335	2654	2694	2734
VC_60UL48	60"W X 98"D X 29"H	35	323	2608	2647	2686

42" X 20" bridge units

VC_72UL42	72"W X 98"D X 29"H	41	345	2657	2697	2737
VC_66UL42	66"W X 98"D X 29"H	38	330	2614	2653	2692
VC_60UL42	60"W X 98"D X 29"H	35	318	2569	2608	2646

- For front locking Box/box/file pedestal on left side, add suffix -3 after model number
- For front locking File/file pedestal on left side, add suffix -2 after model number
- Metal post legs and 8" raised satin acrylic modesty panel on 30" deep table desk
- Bridge with high profile modesty panel
- Pedestal and end gables are inset by 3"
- Table desk and bridge requires simple assembly using supplied hardware
- Credenza ships fully assembled

Left Executive U-Shape Station with Integrated Hutch

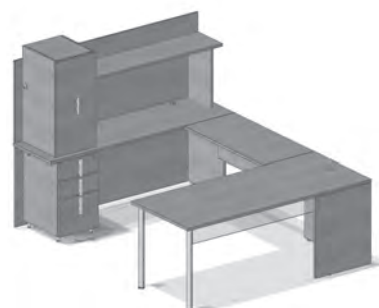

Freight Class: 125

48" X 20" bridge units

MODEL NUMBER	FOOT PRINT	CUBIC FT	SHIP WEIGHT	Zone Pricing		
VC_72UL48H	72"W X 98"D X 29/62"H	71	492	3733	3789	3845
VC_66UL48H	66"W X 98"D X 29/62"H	65	472	3678	3733	3788
VC_60UL48H	60"W X 98"D X 29/62"H	60	454	3618	3672	3727

42" X 20" bridge units

VC_72UL42H	72"W X 98"D X 29"H	71	487	3695	3750	3806
VC_66UL42H	66"W X 98"D X 29"H	65	467	3640	3695	3749
VC_60UL42H	60"W X 98"D X 29"H	60	449	3580	3634	3687

- For front locking Box/box/file pedestal on left side, add suffix -3 after model number
- For front locking File/file pedestal on left side, add suffix -2 after model number
- Metal post legs and 8" raised satin acrylic modesty panel on 30" deep table desk
- Bridge with high profile modesty panel
- Pedestal and end gables are inset by 3"
- Table desk and bridge requires simple assembly using supplied hardware
- Hutch and credenza ship fully assembled

Configurations

Right L-Shape Computer Station

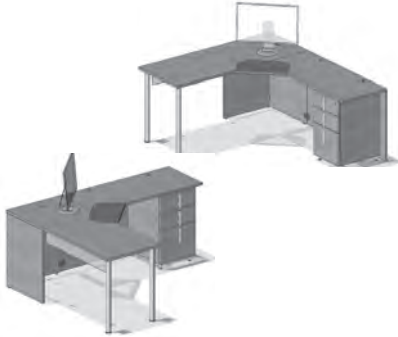

Freight Class: 100

30" main surface and 20" return depth

MODEL NUMBER	FOOT PRINT	CUBIC FT	SHIP WEIGHT	Zone Pricing		
VC_72LR42	72"W X 72"D X 29"H	26	253	2122	2154	2186
VC_66LR42	66"W X 72"D X 29"H	25	246	2093	2124	2156
VC_60LR42	60"W X 72"D X 29"H	25	241	2063	2094	2125

24" main surface and 20" return depth

MODEL NUMBER	FOOT PRINT	CUBIC FT	SHIP WEIGHT	Zone Pricing		
VC_72LR48	72"W X 72"D X 29"H	28	239	2041	2072	2102
VC_66LR48	66"W X 72"D X 29"H	27	234	2018	2048	2079
VC_60LR48	60"W X 72"D X 29"H	27	230	1993	2023	2053

- For front locking Box/box/file pedestal on right, please add -3 after model number
- For front locking File/file pedestal on right, please add -2 after model number
- Metal post legs, 8" raised satin acrylic modesty panel on desk and full height side panels
- Pedestal is inset by 3"
- Table desk requires simple assembly using supplied hardware
- Monitor and XDECCA computer corner add-on are shown, but not included
- Return unit ships fully assembled

Right L-Shape Computer Station with Integrated Hutch

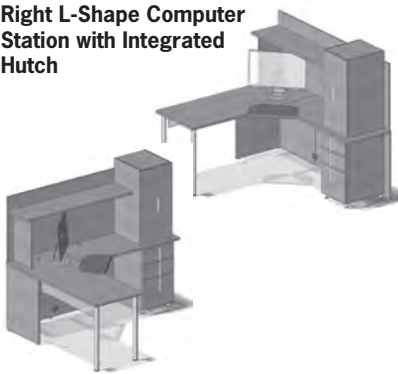

Freight Class: 125

30" main surface and 20" return depth

MODEL NUMBER	FOOT PRINT	CUBIC FT	SHIP WEIGHT	Zone Pricing		
VC_72LR42H	72"W X 72"D X 29/62"H	56	395	3159	3206	3254
VC_66LR42H	66"W X 72"D X 29/62"H	55	388	3118	3165	3212
VC_60LR42H	60"W X 72"D X 29/62"H	55	383	3073	3119	3165

24" main surface and 20" return depth

MODEL NUMBER	FOOT PRINT	CUBIC FT	SHIP WEIGHT	Zone Pricing		
VC_72LR48H	72"W X 72"D X 29/62"H	58	381	3079	3125	3171
VC_66LR48H	66"W X 72"D X 29/62"H	57	371	3056	3102	3148
VC_60LR48H	60"W X 72"D X 29/62"H	57	361	3030	3075	3121

- For front locking Box/box/file pedestal on right, please add -3 after model number
- For front locking File/file pedestal on right, please add -2 after model number
- Metal post legs, 8" raised satin acrylic modesty panel on desk and full height side panels
- Pedestal is inset by 3"
- Monitor and XDECCA computer corner add-on are shown, but not included
- Table desk requires simple assembly using supplied hardware
- Hutch and return unit ship fully assembled

Right Executive U-Shape Computer Station

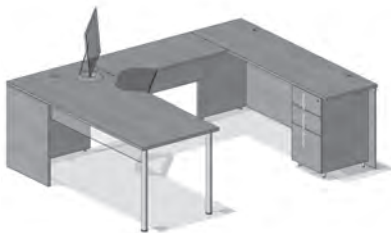

Freight Class: 100

48" X 20" bridge units

MODEL NUMBER	FOOT PRINT	CUBIC FT	SHIP WEIGHT	Zone Pricing		
VC_72UR48	72"W X 98"D X 29"H	41	350	2696	2736	2777
VC_66UR48	66"W X 98"D X 29"H	38	335	2654	2694	2734
VC_60UR48	60"W X 98"D X 29"H	35	323	2608	2647	2686

42" X 20" bridge units

MODEL NUMBER	FOOT PRINT	CUBIC FT	SHIP WEIGHT	Zone Pricing		
VC_72UR42	72"W X 98"D X 29"H	41	345	2657	2697	2737
VC_66UR42	66"W X 98"D X 29"H	38	330	2614	2653	2692
VC_60UR42	60"W X 98"D X 29"H	35	318	2569	2608	2646

- For front locking Box/box/file pedestal on right, add -3 after model number
- For front locking File/file pedestal on right, add -2 after model number
- Metal post legs and 8" raised satin acrylic modesty panel on 30" deep table desk
- Bridge with high profile modesty panel
- Pedestal and end gables are inset by 3"
- Monitor and XDECCA computer corner add-on are shown, but not included
- Table desk and bridge requires simple assembly using supplied hardware
- Credenza ships fully assembled

Right Executive U-Shape Computer Station with Integrated Hutch

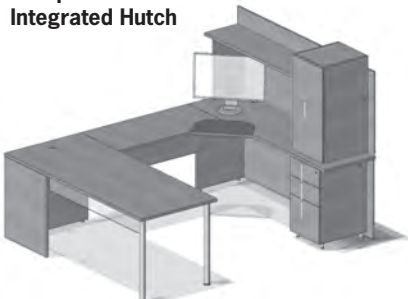

Freight Class: 125







48" X 20" bridge units

MODEL NUMBER	FOOT PRINT	CUBIC FT	SHIP WEIGHT	Zone Pricing		
VC_72UR48H	72"W X 98"D X 29/62"H	71	492	3733	3789	3845
VC_66UR48H	66"W X 98"D X 29/62"H	65	472	3678	3733	3788
VC_60UR48H	60"W X 98"D X 29/62"H	60	454	3618	3672	3727

42" X 20" bridge units

MODEL NUMBER	FOOT PRINT	CUBIC FT	SHIP WEIGHT	Zone Pricing		
VC_72UR42H	72"W X 98"D X 29"H	71	487	3695	3750	3806
VC_66UR42H	66"W X 98"D X 29"H	65	467	3640	3695	3749
VC_60UR42H	60"W X 98"D X 29"H	60	449	3580	3634	3687







- For front locking Box/box/file pedestal on right, add -3 after model number
- For front locking File/file pedestal on right, add -2 after model number
- Metal post legs and 8" raised satin acrylic modesty panel on 30" deep table desk
- Bridge with high profile modesty panel
- Pedestal and end gables are inset by 3"
- Monitor and XDECCA computer corner add-on are shown, but not included
- Table desk and bridge requires simple assembly using supplied hardware
- Hutch and credenza ship fully assembled

Desks		Zone Pricing	1	2	3		
 <ul style="list-style-type: none"> • Box/box/file pedestal on each side • 30" deep left pedestal • 24" deep right pedestal • Front locks • Desk ships fully assembled 	VC_7230DL3	72" X 30" X 29"	Cubic Ft: 42	Ship Weight: 295	1904	1933	1961
	VC_6630DL3	66" X 30" X 29"	Cubic Ft: 39	Ship Weight: 286	1882	1910	1938
	Freight Class: 125						
 <ul style="list-style-type: none"> • Front locking box/box/file pedestal on left • Full end panel on right • Open center modesty with 8" raised satin acrylic modesty panel • Ships fully assembled 	VC_7230L3	72" X 30" X 29"	Cubic Ft: 42	Ship Weight: 222	1497	1519	1542
	Freight Class: 150						
	 <ul style="list-style-type: none"> • Front locking box/box/file pedestal on left • Metal post legs and 8" raised satin acrylic modesty panel • Table desk ships fully assembled 	VC_7230TL3	72" X 30" X 29"	Cubic Ft: 42	Ship Weight: 197	1557	1580
VC_6630TL3		66" X 30" X 29"	Cubic Ft: 39	Ship Weight: 190	1528	1551	1574
VC_6030TL3		60" X 30" X 29"	Cubic Ft: 36	Ship Weight: 185	1498	1520	1543
Freight Class: 150							
 <ul style="list-style-type: none"> • Metal post legs and 8" raised satin acrylic modesty panel • Side gable can be installed inset by 3" for U-shape and flush for L-shape assemblies • Table ships knocked down for assembly in the field 	VC_7230TL	72" X 30" X 29"	Cubic Ft: 9	Ship Weight: 124	1135	1152	1169
	VC_6630TL	66" X 30" X 29"	Cubic Ft: 8	Ship Weight: 117	1106	1123	1139
	VC_6030TL	60" X 30" X 29"	Cubic Ft: 8	Ship Weight: 112	1076	1092	1108
	VC_7224TL	72" X 24" X 29"	Cubic Ft: 8	Ship Weight: 104	1039	1055	1070
	VC_6624TL	66" X 24" X 29"	Cubic Ft: 7	Ship Weight: 99	1017	1032	1048
	VC_6024TL	60" X 24" X 29"	Cubic Ft: 7	Ship Weight: 95	992	1007	1022
Freight Class: 85							
 <ul style="list-style-type: none"> • Front locking pedestal • Pedestal is inset by 3" • Return ships fully assembled 	VC_2048L3	48" X 20" X 29"	Cubic Ft: 20	Ship Weight: 135	1002	1017	1032
	VC_2042L3	42" X 20" X 29"	Cubic Ft: 17	Ship Weight: 129	986	1001	1016
	Freight Class: 125						
 <ul style="list-style-type: none"> • Front locking pedestal • Pedestal is inset by 3" • Return ships fully assembled 	VC_2048L2	48" X 20" X 29"	Cubic Ft: 20	Ship Weight: 135	1002	1017	1032
	VC_2042L2	42" X 20" X 29"	Cubic Ft: 17	Ship Weight: 129	986	1001	1016
	Freight Class: 125						
 <ul style="list-style-type: none"> • Four metal post legs and center 8" raised satin acrylic modesty panel • Top includes leg braces for stability • Table ships knocked down for assembly in the field 	VC_7230T	72" X 30" X 29"	Cubic Ft: 8	Ship Weight: 109	1139	1156	1173
	VC_6630T	66" X 30" X 29"	Cubic Ft: 7	Ship Weight: 101	1097	1113	1130
	VC_6030T	60" X 30" X 29"	Cubic Ft: 7	Ship Weight: 95	1055	1071	1087
	Freight Class: 85						

CONTEMPORARY LAMINATE

FINISH SELECTION

BLACK **E** | BOARDWALK **BW** | DRIFTWOOD **DW** |
 ESPRESSO **X** | GRAPHITE **GP** | MAHOGANY **M** | NATURAL
 MAPLE **FM** | SHORELINE **SL** | WINDSOR CHERRY **WC** |

		Zone Pricing		1	2	3	
 <p>Right Double Pedestal Desk</p> <ul style="list-style-type: none"> • Box/box/file pedestal on each side • 30" deep right pedestal • 24" deep left pedestal • Front locks • Desk ships fully assembled <p>Freight Class: 125</p>	VC_7230DR3	72" X 30" X 29"	Cubic Ft: 42	Ship Weight: 295	1904	1933	1961
	VC_6630DR3	66" X 30" X 29"	Cubic Ft: 39	Ship Weight: 286	1882	1910	1938
 <p>Right Single Pedestal Desk</p> <ul style="list-style-type: none"> • Front locking box/box/file pedestal on right • Full end panel on left • Open center modesty with 8" raised satin acrylic modesty panel • Ships fully assembled <p>Freight Class: 150</p>	VC_7230R3	72" X 30" X 29"	Cubic Ft: 42	Ship Weight: 222	1497	1519	1542
 <p>Right Single Pedestal Table Desk</p> <ul style="list-style-type: none"> • Box/box/file pedestal • Metal post legs and 8" raised satin acrylic modesty panel • Table desk ships fully assembled <p>Freight Class: 150</p>	VC_7230TR3	72" X 30" X 29"	Cubic Ft: 42	Ship Weight: 197	1557	1580	1604
	VC_6630TR3	66" X 30" X 29"	Cubic Ft: 39	Ship Weight: 190	1528	1551	1574
	VC_6030TR3	60" X 30" X 29"	Cubic Ft: 36	Ship Weight: 185	1498	1520	1543
 <p>Right Table Desk</p> <ul style="list-style-type: none"> • Metal post legs and 8" raised satin acrylic modesty panel • Side gable can be installed inset by 3" for U-shape and flush for L-shape assemblies • Table ships knocked down for assembly in the field <p>Freight Class: 85</p>	VC_7230TR	72" X 30" X 29"	Cubic Ft: 9	Ship Weight: 124	1135	1152	1169
	VC_6630TR	66" X 30" X 29"	Cubic Ft: 8	Ship Weight: 117	1106	1123	1139
	VC_6030TR	60" X 30" X 29"	Cubic Ft: 8	Ship Weight: 112	1076	1092	1108
	VC_7224TR	72" X 24" X 29"	Cubic Ft: 8	Ship Weight: 104	1039	1055	1070
	VC_6624TR	66" X 24" X 29"	Cubic Ft: 7	Ship Weight: 99	1017	1032	1048
	VC_6024TR	60" X 24" X 29"	Cubic Ft: 7	Ship Weight: 95	992	1007	1022
 <p>Right Box/Box/File Single Pedestal Return</p> <ul style="list-style-type: none"> • Front locking pedestal • Pedestal is inset by 3" • Return ships fully assembled <p>Freight Class: 125</p>	VC_2048R3	48" X 20" X 29"	Cubic Ft: 20	Ship Weight: 135	1002	1017	1032
	VC_2042R3	42" X 20" X 29"	Cubic Ft: 17	Ship Weight: 129	986	1001	1016
 <p>Right File/File Single Pedestal Return</p> <ul style="list-style-type: none"> • Front locking pedestal • Pedestal is inset by 3" • Return ships fully assembled <p>Freight Class: 125</p>	VC_2048R2	48" X 20" X 29"	Cubic Ft: 20	Ship Weight: 135	1002	1017	1032
	VC_2042R2	42" X 20" X 29"	Cubic Ft: 17	Ship Weight: 129	986	1001	1016
 <p>Bridge</p> <ul style="list-style-type: none"> • Bridge ships knocked down for assembly in the field <p>Freight Class: 70</p>	VC_2048	48" X 20" X 29"	Cubic Ft: 8	Ship Weight: 109	367	373	378
	VC_2042	42" X 20" X 29"	Cubic Ft: 7	Ship Weight: 101	329	334	339

CONTEMPORARY LAMINATE

Single Tower Left Hutch



- Tower with hinged door and one adjustable shelf on right side and fixed shelf on left side
- Hutch placed over credenza will be approximately 62" high
- Hutch ships fully assembled

Freight Class: 150

				Zone Pricing	1	2	3
VC_OH7220L	72" X 18" X 32"	Cubic Ft: 32	Ship Weight: 142		1037	1053	1068
VC_OH6620L	66" X 18" X 32"	Cubic Ft: 32	Ship Weight: 137		1025	1040	1056
VC_OH6020L	60" X 18" X 32"	Cubic Ft: 32	Ship Weight: 131		1010	1025	1040

Single Tower Right Hutch



- Tower with hinged door and one adjustable shelf on right side and fixed shelf on left side
- Hutch placed over credenza will be approximately 62" high
- Hutch ships fully assembled

Freight Class: 150

VC_OH7220R	72" X 18" X 32"	Cubic Ft: 32	Ship Weight: 142		1037	1053	1068
VC_OH6620R	66" X 18" X 32"	Cubic Ft: 32	Ship Weight: 137		1025	1040	1056
VC_OH6020R	60" X 18" X 32"	Cubic Ft: 32	Ship Weight: 131		1010	1025	1040

Box/Box/File Single Pedestal Credenza



- Front locking pedestal
- Pedestal and gable are inset 3" from ends
- Credenza ships fully assembled

Freight Class: 125

VC_7220L3 Shown

VC_7220L3	72" X 20" X 29"	Cubic Ft: 29	Ship Weight: 178		1193	1211	1229
VC_6620L3	66" X 20" X 29"	Cubic Ft: 27	Ship Weight: 170		1180	1198	1215
VC_6020L3	60" X 20" X 29"	Cubic Ft: 24	Ship Weight: 163		1164	1181	1199
VC_7220R3	72" X 20" X 29"	Cubic Ft: 29	Ship Weight: 178		1193	1211	1229
VC_6620R3	66" X 20" X 29"	Cubic Ft: 27	Ship Weight: 170		1180	1198	1215
VC_6020R3	60" X 20" X 29"	Cubic Ft: 24	Ship Weight: 163		1164	1181	1199

File/File Single Pedestal Credenza



- Front locking pedestal
- Pedestal and gable are inset 3" from ends
- Credenza ships fully assembled

Freight Class: 125

VC_7220L2 Shown

VC_7220L2	72" X 20" X 29"	Cubic Ft: 29	Ship Weight: 178		1193	1211	1229
VC_6620L2	66" X 20" X 29"	Cubic Ft: 27	Ship Weight: 170		1180	1198	1215
VC_6020L2	60" X 20" X 29"	Cubic Ft: 24	Ship Weight: 163		1164	1181	1199
VC_7220R2	72" X 20" X 29"	Cubic Ft: 29	Ship Weight: 178		1193	1211	1229
VC_6620R2	66" X 20" X 29"	Cubic Ft: 27	Ship Weight: 170		1180	1198	1215
VC_6020R2	60" X 20" X 29"	Cubic Ft: 24	Ship Weight: 163		1164	1181	1199

Lateral File Single Pedestal Credenza



- Front locking pedestal
- Pedestal and gable are inset 3" from ends
- Credenza ships fully assembled

Freight Class: 100

VC_7220LF Shown

VC_7220LF	72" X 20" X 29"	Cubic Ft: 29	Ship Weight: 243		1474	1496	1518
VC_6620LF	66" X 20" X 29"	Cubic Ft: 27	Ship Weight: 235		1460	1482	1504
VC_6020LF	60" X 20" X 29"	Cubic Ft: 24	Ship Weight: 228		1446	1468	1489
VC_7220RF	72" X 20" X 29"	Cubic Ft: 29	Ship Weight: 243		1474	1496	1518
VC_6620RF	66" X 20" X 29"	Cubic Ft: 27	Ship Weight: 235		1460	1482	1504
VC_6020RF	60" X 20" X 29"	Cubic Ft: 24	Ship Weight: 228		1446	1468	1489

Storage Single Pedestal Credenza



- Includes one adjustable shelf. Optional door lock available
- Pedestal and gable are inset 3" from ends
- Credenza ships fully assembled

Freight Class: 125

VC_7220LS Shown

VC_7220LS	72" X 20" X 29"	Cubic Ft: 29	Ship Weight: 208		1133	1150	1167
VC_6620LS	66" X 20" X 29"	Cubic Ft: 27	Ship Weight: 200		1120	1137	1154
VC_6020LS	60" X 20" X 29"	Cubic Ft: 24	Ship Weight: 193		1105	1122	1138
VC_7220RS	72" X 20" X 29"	Cubic Ft: 29	Ship Weight: 208		1133	1150	1167
VC_6620RS	66" X 20" X 29"	Cubic Ft: 27	Ship Weight: 200		1120	1137	1154
VC_6020RS	60" X 20" X 29"	Cubic Ft: 24	Ship Weight: 193		1105	1122	1138

FINISH SELECTION

BLACK **E** | BOARDWALK **BW** | DRIFTWOOD **DW** |
 ESPRESSO **X** | GRAPHITE **GP** | MAHOGANY **M** | NATURAL
 MAPLE **FM** | SHORELINE **SL** | WINDSOR CHERRY **WC** |

Double Tower Hutch



- Two towers with hinged doors and one adjustable shelf
- Fixed shelf on center space
- Hutch on credenza will be approximately 62" high
- Hutch ships fully assembled

Freight Class: 125

				Zone Pricing	1	2	3
VC_OH7220	72" X 18" X 29"	Cubic Ft: 30	Ship Weight: 198		1448	1470	1491
VC_OH6620	66" X 18" X 29"	Cubic Ft: 27	Ship Weight: 193		1438	1460	1481
VC_OH6020	60" X 18" X 29"	Cubic Ft: 25	Ship Weight: 187		1422	1443	1465

Double Pedestal Credenza



- File/file pedestal at each end, with full width 3" extended back panel
- Front locks
- Credenza ships fully assembled

Freight Class: 100

VC_7220-4	72" X 20" X 29"	Cubic Ft: 29	Ship Weight: 237		1631	1655	1680
VC_6620-4	66" X 20" X 29"	Cubic Ft: 27	Ship Weight: 229		1617	1641	1666
VC_6020-4	60" X 20" X 29"	Cubic Ft: 24	Ship Weight: 222		1602	1626	1650

Executive Storage Credenza



- File/file pedestal at each end, with full width 3" extended back panel
- Front locks
- Recessed hinged door section in the center with one adjustable shelf
- Credenza ships fully assembled
- Optional door lock available

Freight Class: 100

VC_7220-4S	72" X 20" X 29"	Cubic Ft: 29	Ship Weight: 277		1961	1990	2020
VC_6620-4S	66" X 20" X 29"	Cubic Ft: 27	Ship Weight: 264		1934	1963	1992
VC_6020-4S	60" X 20" X 29"	Cubic Ft: 24	Ship Weight: 252		1906	1935	1963

Double Lateral File Credenza



- Front lock on each file pedestal
- Credenza ships fully assembled

Freight Class: 92.5

VC_7220DLF	72" X 20" X 29"	Cubic Ft: 29	Ship Weight: 367		2281	2315	2349
-------------------	-----------------	--------------	------------------	--	-------------	-------------	-------------

Double Storage Credenza



- One adjustable shelf in each storage unit
- Credenza ships fully assembled
- Optional door locks available

Freight Class: 125

VC_7220DS	72" X 20" X 29"	Cubic Ft: 29	Ship Weight: 297		1578	1602	1625
------------------	-----------------	--------------	------------------	--	-------------	-------------	-------------

Lateral File and Storage Credenza



- Front lock on lateral file unit
- One adjustable shelf in storage unit
- Credenza ships fully assembled
- Optional door lock available

Freight Class: 92.5

VC_7220LFS	72" X 20" X 29"	Cubic Ft: 29	Ship Weight: 332		1928	1957	1986
-------------------	-----------------	--------------	------------------	--	-------------	-------------	-------------

Zone Pricing	1	2	3
--------------	---	---	---

Desk Top Storage Unit



- Tower with hinged door and one fixed shelf
- Tower on desk will be approximately 50" high
- Tower ships fully assembled

Freight Class: 85

Door opens to left						
VC_DSL	16" X 16" X 21"	Cubic Ft: 4	Ship Weight: 45	560	568	577

Door opens to right						
VC_DSR	16" X 16" X 21"	Cubic Ft: 4	Ship Weight: 45	560	568	577

Single Tower Carrel



- Tower with hinged door and one fixed shelf
- Carrel on desk will be approximately 50" high
- Carrel ships fully assembled

Freight Class: 250

Left side tower unit						
VC_72DGL	72" X 17" X 21"	Cubic Ft: 19	Ship Weight: 69	757	768	780

VC_66DGL	66" X 17" X 21"	Cubic Ft: 17	Ship Weight: 67	748	759	770
-----------------	-----------------	--------------	-----------------	------------	------------	------------

VC_60DGL	60" X 17" X 21"	Cubic Ft: 16	Ship Weight: 65	742	753	764
-----------------	-----------------	--------------	-----------------	------------	------------	------------

Right side tower unit						
VC_72DGR	72" X 17" X 21"	Cubic Ft: 19	Ship Weight: 69	757	768	780

VC_66DGR	66" X 17" X 21"	Cubic Ft: 17	Ship Weight: 67	748	759	770
-----------------	-----------------	--------------	-----------------	------------	------------	------------

VC_60DGR	60" X 17" X 21"	Cubic Ft: 16	Ship Weight: 65	742	753	764
-----------------	-----------------	--------------	-----------------	------------	------------	------------

Gallery Counter Shelf



- Gallery counter will fit left or right side of single tower carrel
- Gallery counter on desk will be approximately 41" high
- Field assembled with quick connectors

Freight Class: 85

VC_42TC	42" X 13" X 12"	Cubic Ft: 2	Ship Weight: 32	379	385	390
----------------	-----------------	-------------	-----------------	------------	------------	------------

VC_36TC	36" X 13" X 12"	Cubic Ft: 2	Ship Weight: 30	363	368	374
----------------	-----------------	-------------	-----------------	------------	------------	------------

VC_30TC	30" X 13" X 12"	Cubic Ft: 2	Ship Weight: 28	347	352	357
----------------	-----------------	-------------	-----------------	------------	------------	------------

VC_24TC	24" X 13" X 12"	Cubic Ft: 1	Ship Weight: 26	332	337	342
----------------	-----------------	-------------	-----------------	------------	------------	------------

Double Tower Carrel



- Tower with hinged door and one fixed shelf
- Carrel on credenza will be approximately 50" high
- Carrel ships fully assembled

VC_72DG	72" X 17" X 21"	Cubic Ft: 19	Ship Weight: 114	1302	1322	1341
----------------	-----------------	--------------	------------------	-------------	-------------	-------------

VC_66DG	66" X 17" X 21"	Cubic Ft: 17	Ship Weight: 112	1293	1312	1332
----------------	-----------------	--------------	------------------	-------------	-------------	-------------

VC_60DG	60" X 17" X 21"	Cubic Ft: 16	Ship Weight: 110	1287	1306	1326
----------------	-----------------	--------------	------------------	-------------	-------------	-------------

Mobile Pedestals



- Front locking box/file pedestal, legal and letter filing
- Four casters, two locking on front
- For optional seat cushion, order XD-1618SC

Freight Class: 100

VC_20	16" X 20" X 22"	Cubic Ft: 6	Ship Weight: 85	739	750	761
--------------	-----------------	-------------	-----------------	------------	------------	------------

Stationary Bench Drawer Pedestal



- Front locking drawer
- Four 2" legs with levelers
- Legal and letter filing
- For optional seat cushion, order XD-1620SC

Freight Class: 85

VC_1620P	16" X 20" X 19"	Cubic Ft: 5	Ship Weight: 78	842	855	867
-----------------	-----------------	-------------	-----------------	------------	------------	------------

Stationary Bench Table Pedestal



- Open on one side
- Four 2" legs with levelers
- Table cube ships fully assembled
- For seat cushion, order XD2020SC below

Freight Class: 85

VC_2020	20" X 20" X 19"	Cubic Ft: 6	Ship Weight: 61	619	628	638
----------------	-----------------	-------------	-----------------	------------	------------	------------

CONTEMPORARY LAMINATE

FINISH SELECTION

BLACK **E** | BOARDWALK **BW** | DRIFTWOOD **DW** |
 ESPRESSO **X** | GRAPHITE **GP** | MAHOGANY **M** | NATURAL
 MAPLE **FM** | SHORELINE **SL** | WINDSOR CHERRY **WC** |

Ganging Tower Storage Add-On



- One fixed shelf and one adjustable shelf
- Includes ganging connectors
- Tower ships fully assembled
- Mount on stationary pedestals

				Zone Pricing	1	2	3
Open bookcase unit				Freight Class: 100			
VC_TSB	16" X 17" X 32"	Cubic Ft: 7	Ship Weight: 65	637	647	656	
Hinged door unit, opens to left				Freight Class: 92.5			
VC_TSL	16" X 18" X 32"	Cubic Ft: 7	Ship Weight: 75	848	861	873	
Hinged door unit, opens to right				Freight Class: 92.5			
VC_TSR	16" X 18" X 32"	Cubic Ft: 7	Ship Weight: 75	848	861	873	

XD-1618SC Seat Cushions for Mobile Pedestal



- Can be added anywhere on surface, anti-skid backing

Freight Class: 250

16" X 18" X 1.5" Cubic Ft: 1 Ship Weight: 2											
Grade	1	2	3	4	5	6	7	8	9	10	L LL
Zone 1	215	232	252	268	284	306	328	350	372	400	451 576
Zone 2	218	235	256	272	288	311	333	355	378	406	458 585
Zone 3	221	239	260	276	293	315	338	361	383	412	465 593

XD-1620SC Seat Cushions for Stationary Drawer Pedestal



- Can be added anywhere on surface, anti-skid backing

Freight Class: 250

16" X 20" X 1.5" Cubic Ft: 1 Ship Weight: 2											
Grade	1	2	3	4	5	6	7	8	9	10	L LL
Zone 1	215	232	252	268	284	306	328	350	372	400	451 576
Zone 2	218	235	256	272	288	311	333	355	378	406	458 585
Zone 3	221	239	260	276	293	315	338	361	383	412	465 593

XD-2020SC Seat Cushions for Stationary Service Pedestal



- Can be added anywhere on surface, anti-skid backing

Freight Class: 250

20" X 20" X 1.5" Cubic Ft: 1 Ship Weight: 3											
Grade	1	2	3	4	5	6	7	8	9	10	L LL
Zone 1	300	330	375	405	438	481	526	569	614	669	773 1021
Zone 2	305	335	381	411	445	488	534	578	623	679	785 1036
Zone 3	309	340	386	417	451	495	542	586	632	689	796 1052

Two Section Chest Pedestal



- Front locking file drawer
- Four 2" legs with levelers
- Pedestal ships fully assembled

Two-drawer pedestal				Freight Class: 70			
VC_3220PP	32" X 20" X 19"	Cubic Ft: 9	Ship Weight: 145	1235	1254	1272	
Open section left, drawer pedestal right				Freight Class: 85			
VC_3220OP	32" X 20" X 19"	Cubic Ft: 9	Ship Weight: 120	1195	1213	1231	
Drawer pedestal left, open section right				Freight Class: 85			
VC_3220PO	32" X 20" X 19"	Cubic Ft: 9	Ship Weight: 120	1195	1213	1231	

Three Section Chest Pedestal



- Front locking file drawer
- Eight 2" legs with levelers
- Pedestal ships fully assembled

Three-drawer pedestal				Freight Class: 70			
VC_4820PPP	48" X 20" X 19"	Cubic Ft: 13	Ship Weight: 218	1885	1913	1942	
Open section left, drawer pedestal middle and right				Freight Class: 85			
VC_4820OPP	48" X 20" X 19"	Cubic Ft: 13	Ship Weight: 193	1843	1871	1898	
Drawer pedestal left and right, open section middle				Freight Class: 85			
VC_4820POP	48" X 20" X 19"	Cubic Ft: 13	Ship Weight: 193	1843	1871	1898	
Drawer pedestal left and middle, open section right				Freight Class: 85			
VC_4820PPO	48" X 20" X 19"	Cubic Ft: 13	Ship Weight: 193	1843	1871	1898	







Wardrobe Cabinet Tower

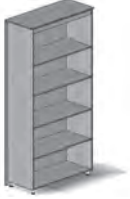

- Coat bar at top and one adjustable shelf
- Will attach to sectional chest pedestals and ganging storage tower add-ons
- Tower ships fully assembled

Freight Class: 125

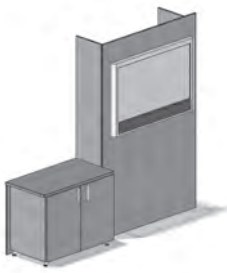

Hinged door cabinet, opens to left						
VC_52WDL	16" X 20" X 52"	Cubic Ft: 13	Ship Weight: 90	1181	1199	1216
Hinged door cabinet, opens to right						
VC_52WDR	16" X 20" X 52"	Cubic Ft: 13	Ship Weight: 90	1181	1199	1216

				Zone Pricing	1	2	3	
Lateral File   <ul style="list-style-type: none"> • Front lock • Anti-tilt mechanism prevents more than one drawer opening at a time • Four 2" legs with levelers 	Two drawer lateral file							
	VC_3620LF	36" X 20" X 29"	Cubic Ft: 15 Ship Weight: 183	1271	1290	1309		
Four drawer lateral file								
VC_3220-4	32" X 20" X 59"	Cubic Ft: 26 Ship Weight: 250	2507	2545	2582			
Freight Class: 100								
Storage Unit  <ul style="list-style-type: none"> • Includes one adjustable shelf • Four 2" legs with levelers • Optional door lock available 	VC_3620S		36" X 20" X 29" Cubic Ft: 15 Ship Weight: 148	919	933	947		
	Freight Class: 100							
Bookcase - Open  <ul style="list-style-type: none"> • Includes 1 fixed shelf at 29" high and three adjustable shelves • Shelves are 3/4" thick and banded on all four edges • Back panel is 3/4" thick and laminated on both sides • Four 2" legs with levelers • Bookcase is shipped fully assembled 	VC_BK3672		36" X 15" X 72" Cubic Ft: 28 Ship Weight: 215	742	753	764		
	Freight Class: 125							
Bookcase Ganging Spacer Connectors  <ul style="list-style-type: none"> • To be used to connect bookcase units 	VC_BKFP		2" X 00" X 72" Cubic Ft: 1 Ship Weight: 10	76	77	78		
	Freight Class: 92.5							
Media Station  <ul style="list-style-type: none"> • Monitor display panel with gables on back connects to 36" wide storage extension on left for added stability • Storage compartment includes one adjustable shelf and wire management grommets • Station ships partially knocked down for assembly in the field using quick-connect hardware • Storage pedestal extension unit is fully assembled • Monitor/TV (shown) and mounting hardware are not included • Optional door lock available 	VC_MDS3648		36/48" X 20" X 75" Cubic Ft: 30 Ship Weight: 316	2364	2399	2435		
	Freight Class: 92.5							
Collaborative Table Console  <ul style="list-style-type: none"> • Table top attaches to media station • Console cabinet support on narrow end conceals collaborative technology • Hinged door allows access to cabinet • Metal post legs on 42" wide end • Ships assembled 	VC_798		72" x 42" x 29" Cubic Ft: 60.5 Ship Weight: 189	1711	1737	1762		
	Marina™ HDMI Collaborative Technology							
	MARW	Gloss White			8347	8472	8597	
	MARS	Silver Pearl			8347	8472	8597	
	MARB	Black			8347	8472	8597	
Mobile Teaming Board  <ul style="list-style-type: none"> • DryErase whiteboard on both sides • Includes markers, eraser and mountable holder • Casters for mobility • Assembly required 	VC_MTB		36" X 24" X 72" Cubic Ft: 10.4 Ship Weight: 158	1155	1172	1190		

CONTEMPORARY LAMINATE

FINISH SELECTION

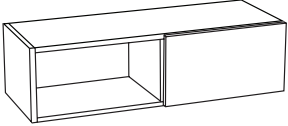
BLACK **E** | BOARDWALK **BW** | DRIFTWOOD **DW** |
 ESPRESSO **X** | GRAPHITE **GP** | MAHOGANY **M** | NATURAL
 MAPLE **FM** | SHORELINE **SL** | WINDSOR CHERRY **WC** |

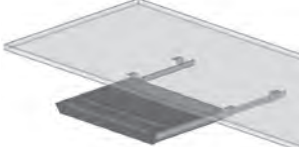
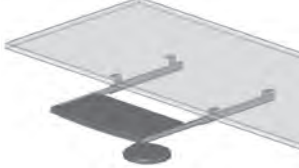
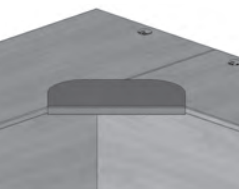
		Zone Pricing	1	2	3
Wall-hung Overhead Storage Unit  <ul style="list-style-type: none"> • Two storage compartments • One sliding door (no pull) • Includes hardwood wall cleat and screws for mounting into wooden wall studs for safety 		V_3610SDW 36" X 13.75" X 10"	869	882	895
LED Task Light  <ul style="list-style-type: none"> • Black with clear lens and warm white light • Convenient on/off switch • Black power cord is 10 ft. long • 720 lumen, 8 watts. 120V • UL labeled • Field installed 		TL2P 21" X 1.25" X 1" Cubic Ft: 1 Ship Weight: 3	212	215	218
Freight Class: 250					
Center Drawer  <ul style="list-style-type: none"> • Injection molded high impact polystyrene with convenience compartments and ball bearing slides • Black color • Field installed 		XDECD20 20.5" X 17" X 2" Cubic Ft: 1.5 Ship Weight: 11	148	150	152
Freight Class: 125					
Pull-Out Keyboard Platform  <ul style="list-style-type: none"> • Black color platform • Gel wristrest • Field installed • Mouse pad swivels 360° 		XDEK20 20" X 11" X 4.5" Cubic Ft: 2 Ship Weight: 12	148	150	152
Freight Class: 125					
Computer Corner Add-On  <ul style="list-style-type: none"> • Hardware supplied • Computer corner add-on is pre-machined to accept the AKT008/06720.5 Articulating Keyboard Platform • Field installed 		XDECCA 19" X 14/14" X 1" Cubic Ft: 1 Ship Weight: 3	148	150	152
Freight Class: 250					

Acrylic Desk Top Privacy Screen

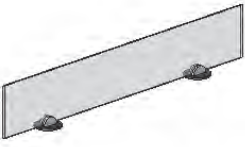

- Screen is fixed to desk surface with hardware supplied
- Will fit on any work surface
- XDAS48 recommended for 72" surface with a desk top tower combination
- XDAS42 recommended for 66" surface with a desk top tower combination
- XDAS36 recommended for 60" surface with a desk top tower combination

Freight Class: 100

				Zone Pricing	1	2	3
XDAS48	48" X 4" X 8"	Cubic Ft: 2	Ship Weight: 16	499	506	514	
XDAS42	42" X 4" X 8"	Cubic Ft: 2	Ship Weight: 15	484	491	499	
XDAS36	36" X 4" X 8"	Cubic Ft: 1	Ship Weight: 15	469	476	483	

Round Grommet



- Black only
- Factory installed
- Must specify location
- Add "G" to sku number
- Grommet opening

Freight Class: 70

G	2" diameter			106	106	106
----------	-------------	--	--	------------	------------	------------

Wire Management Channel



- Horizontal J-channel wire management raceway
- Black only
- Peel and stick self adhesive
- Field installed

Freight Class: 70

MDWM	12" X 1.25" X 2.25"	Cubic Ft: .1	Ship Weight: 1	30	30	31
-------------	---------------------	--------------	----------------	-----------	-----------	-----------

Wire Organizer



- Vertical flexible organizer. Feed from floor monument and fix under work surface
- Black or silver
- Field installed
- Pan-head screws supplied

Freight Class: 150

Black						
ZWB	2.25 dia. X 27"	Cubic Ft: 1	Ship Weight: 4	218	221	225
Silver						
ZWS	2.25 dia. X 27"	Cubic Ft: 1	Ship Weight: 4	218	221	225

Optional Lock



- Factory installed only
- For hinged doors on hutches and credenzas
- Price is per lock
- One lock per set of 2 adjoining doors on credenza
- Add "Y" to sku number

Freight Class: 70

Y				75	75	75
----------	--	--	--	-----------	-----------	-----------

XDTB1448

To fit single tower 72" carrel 49.25" X 1" X 14" Cubic Ft: 1 Ship Weight: 8

Grade	1	2	3	4	5	6	7	8	9	10
Zone 1	264	288	317	326	343	367	377	416	440	470
Zone 2	268	292	322	331	348	373	383	422	447	477
Zone 3	272	297	327	336	353	378	388	428	453	484

XDTB1442

To fit single tower 60" carrel 37.25" X 1" X 14" Cubic Ft: 1 Ship Weight: 6

Grade	1	2	3	4	5	6	7	8	9	10
Zone 1	253	276	302	314	443	357	365	405	428	459
Zone 2	257	280	307	319	450	362	370	411	434	466
Zone 3	261	284	311	323	456	368	376	417	441	473

XDTB1436

To fit single tower 66" carrel 43.25" X 1" X 14" Cubic Ft: 1 Ship Weight: 7

Grade	1	2	3	4	5	6	7	8	9	10
Zone 1	242	263	286	303	322	345	355	393	418	448
Zone 2	246	267	290	308	327	350	360	399	424	455
Zone 3	249	271	295	312	332	355	366	405	431	461



- Fully tackable surface
- Choose any fabric, Quick Ship in QS fabrics. Call for pricing for additional fabric grades
- Field installed

FINISH SELECTION

BLACK **E** | BOARDWALK **BW** | DRIFTWOOD **DW** |
 ESPRESSO **X** | GRAPHITE **GP** | MAHOGANY **M** | NATURAL
 MAPLE **FM** | SHORELINE **SL** | WINDSOR CHERRY **WC** |

XDTB1435

To fit double tower 72" carrel 34.75" X 1" X 14" Cubic Ft: 1 Ship Weight: 6

Grade	1	2	3	4	5	6	7	8	9	10
Zone 1	231	252	275	292	309	334	343	382	407	437
Zone 2	234	256	279	296	314	339	348	388	413	444
Zone 3	238	260	283	301	318	344	353	393	419	450

XDTB1429

To fit double tower 66" carrel 28.75" X 1" X 14" Cubic Ft: 1 Ship Weight: 5

Grade	1	2	3	4	5	6	7	8	9	10
Zone 1	219	240	259	280	299	324	332	371	395	425
Zone 2	222	244	263	284	303	329	337	377	401	431
Zone 3	226	247	267	288	308	334	342	382	407	438

XDTB1423

To fit double tower 60" carrel .75" X 1" X 14" Cubic Ft: 1 Ship Weight 22: 4

Grade	1	2	3	4	5	6	7	8	9	10
Zone 1	208	229	253	267	284	308	317	357	381	411
Zone 2	211	232	257	271	288	313	322	362	387	417
Zone 3	214	236	261	275	293	317	327	368	392	423

XDTB2048

To fit single tower 72" hutch 49.25" X 1" X 19.75" Cubic Ft: 1 Ship Weight: 12

Grade	1	2	3	4	5	6	7	8	9	10
Zone 1	264	288	317	326	343	367	377	416	440	470
Zone 2	268	292	322	331	348	373	383	422	447	477
Zone 3	272	297	327	336	353	378	388	428	453	484

XDTB2042

To fit single tower 66" hutch 43.25" X 1" X 19.75" Cubic Ft: 1 Ship Weight: 10

Grade	1	2	3	4	5	6	7	8	9	10
Zone 1	253	276	302	314	443	357	365	405	428	459
Zone 2	257	280	307	319	450	362	370	411	434	466
Zone 3	261	284	311	323	456	368	376	417	441	473

XDTB2036

To fit single tower 60" hutch 37.25" X 1" X 19.75" Cubic Ft: 1 Ship Weight: 9

Grade	1	2	3	4	5	6	7	8	9	10
Zone 1	242	263	286	303	322	345	355	393	418	448
Zone 2	246	267	290	308	327	350	360	399	424	455
Zone 3	249	271	295	312	332	355	366	405	431	461

XDTB2035

To fit single tower 72" hutch 34.75" X 1" X 19.75" Cubic Ft: 1 Ship Weight: 9

Grade	1	2	3	4	5	6	7	8	9	10
Zone 1	231	252	275	292	309	334	343	382	407	437
Zone 2	234	256	279	296	314	339	348	388	413	444
Zone 3	238	260	283	301	318	344	353	393	419	450

XDTB2029

To fit double tower 66" hutch 28.75" X 1" X 19.75" Cubic Ft: 1 Ship Weight: 7

Grade	1	2	3	4	5	6	7	8	9	10
Zone 1	219	240	259	280	299	324	332	371	395	425
Zone 2	222	244	263	284	303	329	337	377	401	431
Zone 3	226	247	267	288	308	334	342	382	407	438

XDTB2023

To fit double tower 60" hutch 22.75" X 1" X 19.75" Cubic Ft: 1 Ship Weight: 5

Grade	1	2	3	4	5	6	7	8	9	10
Zone 1	208	229	253	267	284	308	317	357	381	411
Zone 2	211	232	257	271	288	313	322	362	387	417
Zone 3	214	236	261	275	293	317	327	368	392	423



- Fully tackable surface
- Choose any fabric, Quick Ship in QS fabrics. Call for pricing for additional fabric grades
- Field installed

Accessory Wall 7" High



- Three channel for accessory attachment
- Black color
- Field installed

Freight Class: 70

				Zone Pricing	1	2	3
To fit single tower 72" hutch and carrel							
XDHSAW48	49.25" X .5" X 7"	Cubic Ft: 1.4	Ship Weight:	112	114	115	
To fit single tower 66" hutch and carrel							
XDHSAW42	43.25" X .5" X 7"	Cubic Ft: 1.4	Ship Weight:	112	114	115	
To fit single tower 60" hutch and carrel							
XDHSAW36	37.25" X .5" X 7"	Cubic Ft: 1.4	Ship Weight:	112	114	115	
To fit double tower 72" hutch and carrel							
XDHSAW35	34.75" X .5" X 7"	Cubic Ft: 1.4	Ship Weight:	112	114	115	
To fit double tower 66" hutch and carrel							
XDHSAW29	28.75" X .5" X 7"	Cubic Ft: 1.4	Ship Weight:	112	114	115	
To fit double tower 60" hutch and carrel							
XDHSAW23	22.75" X .5" X 7"	Cubic Ft: 1.4	Ship Weight:	112	114	115	

Letter Size Paper Tray



- To fit accessory wall rail
- Stores letter size sheets
- 5 lb. capacity
- Black color

Freight Class: 125

MD1003	9.5" X 14" X 2"	Cubic Ft:	Ship Weight:	53	54	55	
---------------	-----------------	-----------	--------------	-----------	-----------	-----------	--

Legal Size Paper Tray



- To fit accessory wall rail
- Stores legal size sheets
- 7 lb. capacity
- Black color

Freight Class: 150

MD1007	15" X 10.5" X 2"	Cubic Ft:	Ship Weight:	53	54	55	
---------------	------------------	-----------	--------------	-----------	-----------	-----------	--

Pen Holder



- To fit accessory wall rail
- Stores legal size sheets
- 7 lb. capacity
- Black color

Freight Class: 400

MD1000	4" X 3.5" X 4"	Cubic Ft:	Ship Weight:	18	18	19	
---------------	----------------	-----------	--------------	-----------	-----------	-----------	--

Phone Base



- To fit accessory wall rail
- 5 lb. capacity
- Black color

Freight Class: 150

MD1005	8.5" X 9.5" X 2"	Cubic Ft:	Ship Weight:	42	43	43	
---------------	------------------	-----------	--------------	-----------	-----------	-----------	--

Binder Holder



- To fit accessory wall rail
- Store binders, phone books, etc.
- 10 lb. capacity
- Black color

Freight Class: 400

MD1009	5" X 9" X 10.58"	Cubic Ft:	Ship Weight:	28	28	29	
---------------	------------------	-----------	--------------	-----------	-----------	-----------	--

Folder Tray



- To fit accessory wall rail
- Store files vertically
- 10 lb. capacity
- Black color

Freight Class: 300

MD1008	7" X 12.5" X 8"	Cubic Ft:	Ship Weight:	61	62	63	
---------------	-----------------	-----------	--------------	-----------	-----------	-----------	--

CHARACTERISTICS

Pedestals, Credenzas, File Cabinets and Storage Units: Pedestal cases are ¾" thick core surfaced on both sides with laminate and edge banded as required. Units fully assembled with dowels, glue, wood cleats, metal brackets and screws. Series features full modesty panels.

FINISHES

All models available in Mahogany and Windsor Cherry wood grain thermally fused laminate on vertical surfaces with high pressure laminate (HPL) Tops.

TOPS

All tops are surfaced in high-gloss high pressure laminate. All bridge and return tops feature common grain direction with desk/credenza as well as reverse coped edges for smooth work surface connection with desk/credenza. All tops are 1⅜" thick, and are properly backed. All tops feature softly rounded hardwood edges on all four sides. (Note: Tops are high gloss only).

PEDESTALS

Vitality features both full pedestal and ¾ pedestal models. The full pedestal drawer configuration is a box/box/file on all desks, and a file/file on all credenzas and returns. Four preinstalled leveling glides in each pedestal. The ¾ pedestal drawer configuration is box/file.

PULLS

Choose from 3 drawer/door pull options.

- A** Antique Brass
- E** Ebony
- W** Silver

SPECIFICATIONS-Drawers

All drawer fronts are constructed of ¾" thick core surfaced on both sides with laminate and edge banded as required. Drawer sides are ½" thick, grain printed in an oak finish. Drawer bottoms are 1/8" thick hardboard grain printed in an oak finish.

- All box drawers are ¾ extension suspended on smooth action metal slides with steel ball bearings
- All file drawers and file cabinet drawers are mounted on heavy-duty ball bearing, full-extension slides
- All full pedestal desks are equipped with writing slides
- Black filing hardware includes pre-installed rails with easy-adjust crossbar
- All ¾ pedestal file drawers allow letter filing front-to-back and letter/legal

filing side-to-side

- All full pedestal file drawers allow legal filing front-to-back and letter/legal filing side-to-side
- All 36" lateral file drawers allow letter and/or legal filing front-to-back and side-to-side
- 30" and 32" lateral file drawers allow legal filing side-to-side and letter filing front-to-back
- Maximum weight for bottom loading is 25lbs.
- Drawers are constructed with 5 sides for extra strength and durability. The drawer front is the 5th side and is removable in the field for repairs or hardware additions

WIRE MANAGEMENT

All grommets are rectangular 3 1/4" x 1 7/8" and made of black high impact poly resin. See features for number of grommets and location. Additional grommets can be added for extended wire management capability at \$106 list per grommet. Includes factory cut and installed grommet and black sleeve. Specify location with order.

LOCKS

- Individually locking pedestals are standard on all desks and credenzas
- Two drawer lateral files feature individually locking drawers
- Four drawer lateral files feature central locking and are keyed different than other locks due to the anti-tilt mechanism inside the unit
- All locks are keyed identical unless otherwise specified
- 'Key Different' option is \$21 list upcharge per lock. Locks/cores packaged to customer requirements
- Additional lead time for 'Key Different'
- For optional locking on overhead storage units with four wood doors, add **Y** to the end of the model number and add \$150 to the list price of unit

PANELS

¾ pedestal units, bookcases and storage units utilize 1" thick end panels. Heavy-duty adjustable nylon leveling glides are in 5" steel plate on all units. Modesty panels are ¾" thick core.

TACK BOARDS

Fabric covered tackable board may be ordered separately to fit inside hutch. They can be ordered with any fabric to match your office chairs except leather or vinyl. See pages 110-113.

ACCESSORIES *Factory Installed*

Certain accessories can be ordered installed prior to shipment. Add letter designator (C or K) at end of the desk or credenza model number:

- C** Center Drawer
Example: VWM7202BFC
- K** Keyboard Platform
Example: VWM704K

QUICKSHIP

Quick Ship is not available on any items ordered with option.

PACKAGING

All units are properly packed in heavy duty cartons with heavy duty corner pads. All packaging conforms to or exceeds specifications as outlined in the Uniform Freight Classification.

All desks, credenzas, files, and overhead storage units are shipped set up. Modular L-shaped, and U-shaped workstations are shipped in multiple cartons and require connection in the field.

PALLETIZATION

See page 5.

CARE AND CLEANING INSTRUCTIONS

Normal cleaning: Clean using a soft cloth and a good window cleaner which contains no ammonia, followed by wiping dry using a dry soft cloth.

Specifications subject to change without notice.

Configurations

Zone Pricing

1

2

3

**Executive L Unit
3/4 Pedestal**

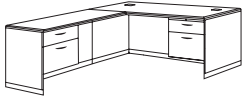

72" x 84" x 29"

Description	Model Number	Qty	Frnt.Class	Cubic Ft.	Ship Weight			
Right Pedestal Desk	V_721R 72" x 36" x 29"	1	200	51.6	250	2120	2152	2184
Desk Height Left Return	V_722L 48" x 24" x 29"	1	110	23.5	159	1466	1488	1510
Total:						3586	3640	3694

**Executive L Unit
Full Pedestal**

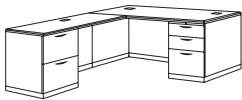

72" x 84" x 29"

Description	Model Number	Qty	Frnt.Class	Cubic Ft.	Ship Weight			
Right Pedestal Desk	V_721R2BF 72" x 36" x 29"	1	110	51.6	298	2689	2729	2770
Desk Height Left Return	V_722LF 48" x 24" x 29"	1	110	24.3	173	1823	1850	1878
Total:						4512	4579	4648

**Executive U Unit
3/4 Pedestal**

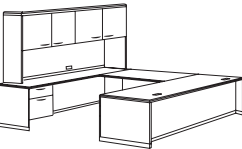

72" x 108" x 65.5"

Description	Model Number	Qty	Frnt.Class	Cubic Ft.	Ship Weight			
Right Pedestal Desk	V_721R 72" x 36" x 29"	1	200	51.6	250	2120	2152	2184
Desk Height Bridge	V_485 48" x 24" x 29"	1	100	4.0	80	908	922	935
Left Pedestal Credenza	V_725L 72" x 24" x 29"	1	125	35.7	175	2009	2039	2069
Overhead Storage Unit	V_737 71" x 18" x 36.5"	1	125	33.6	229	2183	2216	2248
Total:						7220	7329	7436

**Executive U Unit
Full Pedestal**

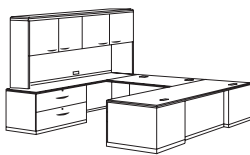

72" x 108" x 65.5"

Description	Model Number	Qty	Frnt.Class	Cubic Ft.	Ship Weight			
Right Pedestal Desk	V_721R2BF 72" x 36" x 29"	1	110	51.6	298	2689	2729	2770
Lateral File Credenza	V_733L 72" x 24" x 29"	1	125	35.7	253	2445	2482	2518
Desk Height Bridge	V_485 48" x 24" x 29"	1	100	4.0	80	908	922	935
Overhead Storage Unit	V_737 71" x 18" x 36.5"	1	125	33.6	229	2183	2216	2248
Total:						8225	8349	8471

**Executive U Unit
with Peninsula Desk**



72" x 108" x 65.5"

Description	Model Number	Qty	Frnt.Class	Cubic Ft.	Ship Weight			
Peninsula Desk	V_799 72" x 36" x 29"	1	125	51.6	166	2136	2168	2200
Lateral File Credenza	V_733L 72" x 24" x 29"	1	125	35.7	253	2445	2482	2518
Desk Height Bridge	V_485 48" x 24" x 29"	1	100	4.0	80	908	922	935
Overhead Storage Unit	V_737 71" x 18" x 36.5"	1	125	33.6	229	2183	2216	2248
Total:						7672	7788	7901

UNIT	KNEESPACE	OVERHANG
72" Double Full Pedestal Desk	36-1/4"	4"
66" Double Full Pedestal Desk	30-1/4"	4"
72" Double Full Pedestal Credenza	36-1/4"	1"
72" Double 3/4 Pedestal Desk	38-1/4"	10-3/8"
66" Double 3/4 Pedestal Desk	32-1/4"	4-3/8"
72" Double 3/4 Pedestal Credenza	38-1/4"	1"

TRANSITIONAL LAMINATE



**Executive Office
3/4 Pedestal**

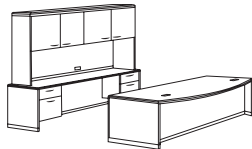

72" x 108" x 65.5"

Description	Model Number	Qty	Frnt.Class	Cubic Ft.	Ship Weight	Zone Pricing			
						1	2	3	
3/4 Double Pedestal Bow Front Desk	V__720B 72" x 36" x 29"	1	110	51.6	298	2808	2850	2892	
3/4 Pedestal Computer Credenza	V__704 72" x 24" x 29"	1	110	35.7	263	2323	2358	2393	
Overhead Storage Unit	V__737 71" x 18" x 36.5"	1	125	33.6	229	2183	2216	2248	
Total:					120.90	790	7314	7424	7533

**Executive Office
Full Pedestal**

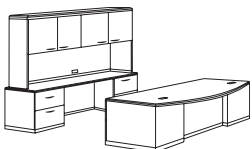

72" x 108" x 65.5"

Description	Model Number	Qty	Frnt.Class	Cubic Ft.	Ship Weight	Zone Pricing			
						1	2	3	
Double Pedestal Bow Front Desk	V__720B2BF 72" x 36" x 29"	1	110	51.6	360	3433	3484	3536	
Full Pedestal Computer Credenza	V__704F 72" x 24" x 29"	1	110	35.7	279	2748	2789	2830	
Overhead Storage Unit	V__737 71" x 18" x 36.5"	1	125	33.6	229	2183	2216	2248	
Total:					120.90	868	8364	8489	8614

Desks

Bow Front Double Pedestal Desk



- Four box drawers
- Two file drawers, letter or legal filing
- Two writing shelves
- Individual locking pedestals
- Two grommets in top

Freight Class: 110

V__720B2BF	72" X 36" X 29"	Cubic Ft: 51.6	Ship Weight: 360	3433	3484	3536	
				Center Drawer C	179	182	184
				Keyboard Platform K	203	206	209
Pulls:	Antique Brass A	Ebony E	Silver W				

Bow Front Left Pedestal Desk



- Two box drawers
- One file drawer, letter or legal filing
- One writing shelf
- Two wire management grommets
- Locking pedestal

Freight Class: 110

V__721LB2BF	72" X 36" X 29"	Cubic Ft: 51.6	Ship Weight: 289	3101	3148	3194	
				Center Drawer C	165	167	170
				Keyboard Platform K	196	199	202
Pulls:	Antique Brass A	Ebony E	Silver W				

Bow Front Right Pedestal Desk



- Two box drawers
- One file drawer, letter or legal filing
- One writing shelf
- Two wire management grommets
- Locking pedestal

Freight Class: 110

V__721RB2BF	72" X 36" X 29"	Cubic Ft: 51.6	Ship Weight: 289	3101	3148	3194	
				Center Drawer C	165	167	170
				Keyboard Platform K	196	199	202
Pulls:	Antique Brass A	Ebony E	Silver W				

Double Pedestal Desk



- Four box drawers
- Two file drawers, letter or legal filing
- Two writing shelves
- Two wire management grommets
- Individually locking pedestals

Freight Class: 110

V__7202BF	72" X 36" X 29"	Cubic Ft: 51.6	Ship Weight: 370	3108	3155	3201	
				Center Drawer C	179	182	184
				Keyboard Platform K	203	206	209
V__6602BF	66" X 30" X 29"	Cubic Ft: 40.2	Ship Weight: 330	2829	2871	2914	
				Center Drawer C	165	167	170
				Keyboard Platform K	199	202	205
Pulls:	Antique Brass A	Ebony E	Silver W				

TRANSITIONAL LAMINATE

Left Pedestal Desk



- Two box drawers
- One file drawer, letter or legal filing
- One writing shelf
- Two wire management grommets
- Locking pedestal

Freight Class: 110

Right Pedestal Desk



- Two box drawers
- One file drawer, letter or legal filing
- One writing shelf
- Two wire management grommets
- Locking pedestal

Freight Class: 110

3/4 Double Pedestal Bow Front Desk

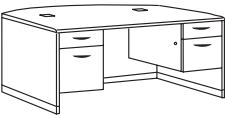

- Two box drawers
- Two file drawers, letter or legal filing
- Two wire management grommets
- individually locking pedestals

Freight Class: 110

3/4 Left Pedestal Bow Front Desk

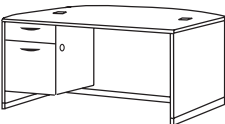

- One box drawer
- One file drawer, letter or legal filing
- Two wire management grommets
- Locking pedestal

Freight Class: 200

3/4 Right Pedestal Bow Front Desk

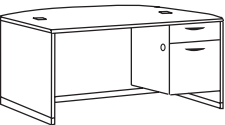

- One box drawer
- One file drawer, letter or legal filing
- Two wire management grommets
- Locking pedestal

Freight Class: 200

3/4 Double Pedestal Desk

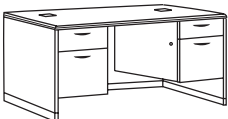

- Two box drawers
- Two file drawers, letter or legal filing
- Two wire management grommets
- Individually locking pedestals

Freight Class: 110

Zone Pricing	1	2	3
--------------	---	---	---

V_721L2BF 72" X 36" X 29" Cubic Ft: 51.6 Ship Weight: 298	2689	2729	2770
Center Drawer C	165	167	170
Keyboard Platform K	196	199	202
V_651L2BF 66" X 30" X 29" Cubic Ft: 40.2 Ship Weight: 262	2349	2384	2419
Center Drawer C	165	167	170
Keyboard Platform K	196	199	202
Pulls: Antique Brass A Ebony E Silver W			

V_721R2BF 72" X 36" X 29" Cubic Ft: 51.6 Ship Weight: 298	2689	2729	2770
Center Drawer C	165	167	170
Keyboard Platform K	196	199	202
V_651R2BF 66" X 30" X 29" Cubic Ft: 40.2 Ship Weight: 262	2349	2384	2419
Center Drawer C	165	167	170
Keyboard Platform K	196	199	202
Pulls: Antique Brass A Ebony E Silver W			

V_720B 72" X 36" X 29" Cubic Ft: 51.6 Ship Weight: 298	2808	2850	2892
Center Drawer C	179	182	184
Keyboard Platform K	203	206	209
Pulls: Antique Brass A Ebony E Silver W			

V_721LB 72" X 36" X 29" Cubic Ft: 51.6 Ship Weight: 250	2413	2449	2485
Center Drawer C	165	167	170
Keyboard Platform K	196	199	202
Pulls: Antique Brass A Ebony E Silver W			

V_721RB 72" X 36" X 29" Cubic Ft: 51.6 Ship Weight: 250	2413	2449	2485
Center Drawer C	165	167	170
Keyboard Platform K	196	199	202
Pulls: Antique Brass A Ebony E Silver W			

V_720 72" X 36" X 29" Cubic Ft: 51.6 Ship Weight: 298	2477	2514	2551
Center Drawer C	179	182	184
Keyboard Platform K	203	206	209
V_660 66" X 30" X 29" Cubic Ft: 40.2 Ship Weight: 259	2253	2287	2321
Center Drawer C	179	182	184
Keyboard Platform K	199	202	205
Pulls: Antique Brass A Ebony E Silver W			



Zone Pricing	1	2	3
--------------	---	---	---

3/4 Left Pedestal Desk

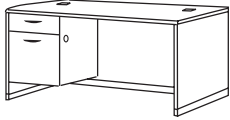

- One box drawer
- One file drawer, letter or legal filing
- Two wire management grommets
- Locking pedestals
- Connect with return or bridge/credenza

Freight Class: 200

V_721L	72" X 36" X 29"	Cubic Ft: 51.6	Ship Weight: 250	2120	2152	2184
				Center Drawer C	165	167
				Keyboard Platform K	196	202
V_651L	66" X 30" X 29"	Cubic Ft: 40.2	Ship Weight: 220	2001	2031	2061
				Center Drawer C	165	167
				Keyboard Platform K	196	202
Pulls:	Antique Brass A	Ebony E	Silver W			

3/4 Right Pedestal Desk

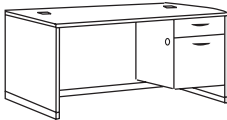

- One box drawer
- One file drawer, letter or legal filing
- Two wire management grommets
- Locking pedestal
- Connect with return or bridge/credenza

Freight Class: 200

V_721R	72" X 36" X 29"	Cubic Ft: 51.6	Ship Weight: 250	2120	2152	2184
				Center Drawer C	165	167
				Keyboard Platform K	196	202
V_651R	66" X 30" X 29"	Cubic Ft: 40.2	Ship Weight: 220	2001	2031	2061
				Center Drawer C	165	167
				Keyboard Platform K	196	202
Pulls:	Antique Brass A	Ebony E	Silver W			

Peninsula Desk

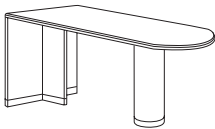

- End support panel
- Cylinder base matches top finish
- Use with returns, bridge/credenza or open leg computer tables

Freight Class: 125

V_799	72" X 36" X 29"	Cubic Ft: 51.6	Ship Weight: 166	2136	2168	2200
--------------	-----------------	----------------	------------------	-------------	-------------	-------------

Credenzas

Full Pedestal Computer Credenza

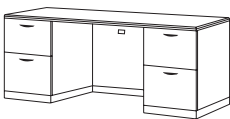

- Four file drawers, letter or legal filing
- One wire management grommet
- Individual locking pedestals

Freight Class: 110

V_704F	72" X 24" X 29"	Cubic Ft: 35.7	Ship Weight: 279	2748	2789	2830
				Keyboard Platform K	203	206
V_604F	66" X 24" X 29"	Cubic Ft: 32.8	Ship Weight: 270	2577	2616	2654
				Keyboard Platform K	199	202
Pulls:	Antique Brass A	Ebony E	Silver W			

Full Pedestal Storage Credenza

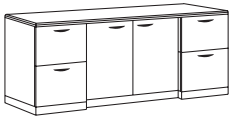

- Four file drawers, letter or legal filing
- Hinged doors with storage compartment in center with one adjustable shelf
- Individually locking pedestals

Freight Class: 125

V_714F	72" X 24" X 29"	Cubic Ft: 35.7	Ship Weight: 333	3286	3335	3385
V_614F	66" X 24" X 29"	Cubic Ft: 32.8	Ship Weight: 300	3110	3157	3203
Pulls:	Antique Brass A	Ebony E	Silver W			

Double Lateral File Credenza



- Four lateral file drawers, letter or legal filing
- Individually locking drawers
- Pre-installed filing hardware

Freight Class: 125

V_733	72" X 24" X 29"	Cubic Ft: 35.7	Ship Weight: 299	2701	2742	2782
Pulls:	Antique Brass A	Ebony E	Silver W			

EXTRA THICK BOTTOM | \$320 **H**

Zone Pricing	1	2	3
--------------	---	---	---

Left Lateral File Credenza

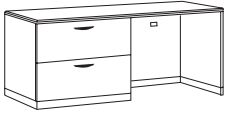

- Two lateral file drawers, letter or legal filing
- One wire management grommet
- Individually locking drawers
- Use with bridge and single pedestal desks

Freight Class: 125

V_ _733L	72" X 24" X 29"	Cubic Ft: 35.7	Ship Weight: 253	2445	2482	2518
V_ _633L	66" X 24" X 29"	Cubic Ft: 32.8	Ship Weight: 233	2353	2388	2424

Pulls:	Antique Brass A	Ebony E	Silver W
---------------	------------------------	----------------	-----------------

EXTRA THICK BOTTOM	\$160 H
---------------------------	---------

Right Lateral File Credenza

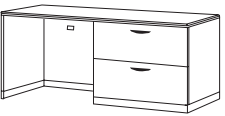

- Two lateral file drawers, letter or legal filing
- One wire management grommet
- Individually locking drawers
- Use with bridge and single pedestal desks

Freight Class: 125

V_ _733R	72" X 24" X 29"	Cubic Ft: 35.7	Ship Weight: 253	2445	2482	2518
V_ _633R	66" X 24" X 29"	Cubic Ft: 32.8	Ship Weight: 233	2353	2388	2424

Pulls:	Antique Brass A	Ebony E	Silver W
---------------	------------------------	----------------	-----------------

EXTRA THICK BOTTOM	\$160 H
---------------------------	---------

Left Full Pedestal Credenza

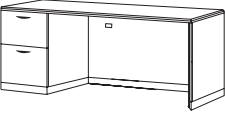

- Two file drawers, letter or legal filing
- One wire management grommet
- Locking pedestal
- Use with bridge and single pedestal desk

Freight Class: 125

V_ _725LF	72" X 24" X 29"	Cubic Ft: 35.7	Ship Weight: 235	2238	2272	2305	
				Keyboard Platform K	196	199	202
V_ _625LF	66" X 24" X 29"	Cubic Ft: 32.8	Ship Weight: 195	2124	2156	2188	
				Keyboard Platform K	196	199	202

Pulls:	Antique Brass A	Ebony E	Silver W
---------------	------------------------	----------------	-----------------

Right Full Pedestal Credenza

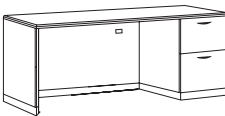

- Two file drawers, letter or legal filing
- One wire management grommet
- Locking pedestal
- Use with bridge and single pedestal desk

Freight Class: 125

V_ _725RF	72" X 24" X 29"	Cubic Ft: 35.7	Ship Weight: 235	2238	2272	2305	
				Keyboard Platform K	196	199	202
V_ _625RF	66" X 24" X 29"	Cubic Ft: 32.8	Ship Weight: 195	2124	2156	2188	
				Keyboard Platform K	196	199	202

Pulls:	Antique Brass A	Ebony E	Silver W
---------------	------------------------	----------------	-----------------

3/4 Pedestal Computer Credenza



- Two box drawers
- Two file drawers, letter or legal filing
- One wire management grommet
- Individually locking pedestals
- Kneespace 36" wide

Freight Class: 110

V_ _704	72" X 24" X 29"	Cubic Ft: 35.7	Ship Weight: 263	2323	2358	2393	
				Keyboard Platform K	199	202	205
V_ _604	66" X 24" X 29"	Cubic Ft: 32.8	Ship Weight: 240	2167	2200	2232	
				Keyboard Platform K	199	202	205

Pulls:	Antique Brass A	Ebony E	Silver W
---------------	------------------------	----------------	-----------------

3/4 Left Pedestal Credenza

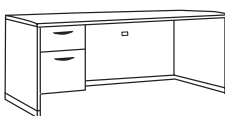

- One box drawer
- One file drawer, letter or legal filing
- One wire management grommet
- Locking pedestal
- Use with bridge and single pedestal desk

Freight Class: 125

V_ _725L	72" X 24" X 29"	Cubic Ft: 35.7	Ship Weight: 175	2009	2039	2069	
				Keyboard Platform K	196	199	202
V_ _625L	66" X 24" X 29"	Cubic Ft: 32.8	Ship Weight: 160	1865	1893	1921	
				Keyboard Platform K	196	199	202

Pulls:	Antique Brass A	Ebony E	Silver W
---------------	------------------------	----------------	-----------------



Zone Pricing	1	2	3
--------------	---	---	---

3/4 Right Pedestal Credenza

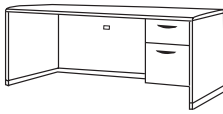

- One box drawer
- One file drawer, letter or legal filing
- One wire management grommet
- Locking pedestal
- Use with bridge and single pedestal desk

Freight Class: 125

V_ _725R	72" X 24" X 29"	Cubic Ft: 35.7	Ship Weight: 175	2009	2039	2069
				Keyboard Platform K	196	202
V_ _625R	66" X 24" X 29"	Cubic Ft: 32.8	Ship Weight: 160	1865	1893	1921
				Keyboard Platform K	196	202
Pulls:	Antique Brass A	Ebony E	Silver W			

Returns & Bridges

Full Pedestal Left Return

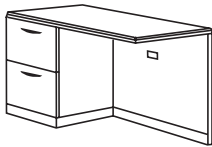

- Two file drawers, letter and legal filing
- One wire management grommet
- Locking pedestal
- Reverse coped edge for smooth work surface connection
- Common grain direction with desk

Freight Class: 110

V_ _722LF	48" X 24" X 29"	Cubic Ft: 24.3	Ship Weight: 173	1823	1850	1878
				Keyboard Platform K	196	202
Pulls:	Antique Brass A	Ebony E	Silver W			

Full Pedestal Right Return

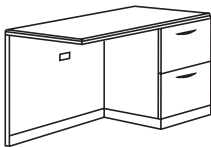

- Two file drawers, letter and legal filing
- One wire management grommet
- Locking pedestal
- Reverse coped edge for smooth work surface connection
- Common grain direction with desk

Freight Class: 110

V_ _722RF	48" X 24" X 29"	Cubic Ft: 24.3	Ship Weight: 173	1823	1850	1878
				Keyboard Platform K	196	202
Pulls:	Antique Brass A	Ebony E	Silver W			

Desk Height 3/4 Pedestal Left Return

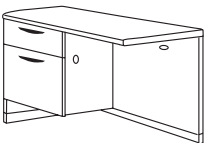

- One box drawer
- One file drawer, letter and legal filing
- One wire management grommet
- Locking pedestal
- Reverse coped edge for smooth work surface connection
- Common grain direction with desk
- Use with computer corner unit, single pedestal desks or credenza

Freight Class: 110

V_ _722L	48" X 24" X 29"	Cubic Ft: 23.5	Ship Weight: 159	1466	1488	1510
				Keyboard Platform K	196	202
Pulls:	Antique Brass A	Ebony E	Silver W			

Desk Height 3/4 Pedestal Right Return

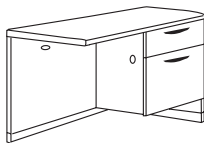

- One box drawer
- One file drawer, letter and legal filing
- One wire management grommet
- Locking pedestal
- Reverse coped edge for smooth work surface connection
- Common grain direction with desk
- Use with computer corner unit, single pedestal desks or credenza

Freight Class: 110

V_ _722R	48" X 24" X 29"	Cubic Ft: 23.5	Ship Weight: 159	1466	1488	1510
				Keyboard Platform K	196	202
Pulls:	Antique Brass A	Ebony E	Silver W			

Desk Height Bridge



- Top has reverse edge detail for a solid, smooth work surface connection
- Common grain direction with desk/credenza
- Two wire management grommets in modesty panel

Freight Class: 110

V_ _485	48" X 24" X 29"	Cubic Ft: 4	Ship Weight: 80	908	922	935
----------------	-----------------	-------------	-----------------	------------	------------	------------

Computer Corners & Tables

Zone Pricing	1	2	3
--------------	---	---	---

Computer Corner Unit

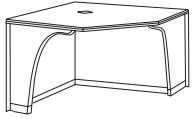

- Open leg support panels
- Three wire management grommets
- Use with computer tables, returns and bridges (24" connection)
- 22" pullup front

V_ _449	42" X 42" X 29"	Cubic Ft: 34.3	Ship Weight: 173	1373	1394	1414
Keyboard Platform K				196	199	202

Freight Class: 200

Left Computer Table Return

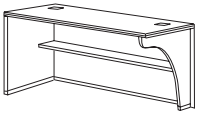

- Open leg panel
- One adjustable shelf
- Two wire management grommets in top and two in modesty panel
- Use with computer corner units, desks, and peninsulas

V_CT48L	48" X 24" X 29"	Cubic Ft: 24.3	Ship Weight: 125	1071	1087	1103
Keyboard Platform K				203	206	209

Freight Class: 200

Right Computer Table Return

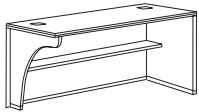

- Open leg panel
- One adjustable shelf
- Two wire management grommets in top and two in modesty panel
- Use with computer corner units, desks, and peninsulas

V_CT48R	48" X 24" X 29"	Cubic Ft: 24.3	Ship Weight: 125	1071	1087	1103
Keyboard Platform K				203	206	209

Freight Class: 200

Computer Table



- One adjustable shelf
- Four wire management grommets

V_CT48	48" X 24" X 29"	Cubic Ft: 24.3	Ship Weight: 135	1081	1097	1113
Keyboard Platform K				203	206	209
V_CT36	36" X 24" X 29"	Cubic Ft: 18.8	Ship Weight: 120	1012	1027	1042
Keyboard Platform K				199	202	205

Freight Class: 110

Files, Bookcases, Storage & Reception Screens

Mobile Pedestal

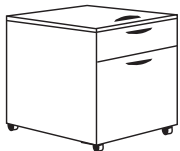

- One box drawer
- One file drawer, letter or legal filing
- Fully locking pedestal
- Dual wheel locking casters
- Top mounted pull for easy mobility

V_ _21	16" X 22" X 22"	Cubic Ft: 6	Ship Weight: 87	826	838	851
---------------	-----------------	-------------	-----------------	------------	------------	------------

Pulls:	Antique Brass A	Ebony E	Silver W
---------------	------------------------	----------------	-----------------

Freight Class: 100

Standard Lateral File



- Two lateral file drawers, letter or legal filing
- Individually locking drawers
- Anti-tilt mechanism inhibits more than one drawer opening at a time
- Hardwood bottom support rail secured with metal bracket at each end

V_ _326	30.75" X 20" X 29"	Cubic Ft: 14	Ship Weight: 140	1725	1751	1777
----------------	--------------------	--------------	------------------	-------------	-------------	-------------

Pulls:	Antique Brass A	Ebony E	Silver W
---------------	------------------------	----------------	-----------------

EXTRA THICK BOTTOM	\$160 H
---------------------------	----------------

Freight Class: 100

TRANSITIONAL LAMINATE



Zone Pricing	1	2	3
--------------	---	---	---

Executive Lateral File

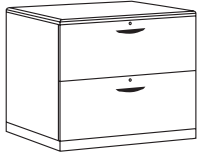

- Two lateral file drawers, letter or legal filing
- Individually locking drawers
- Anti-tilt counter weight
- Hardwood bottom support rail secured with metal bracket at each end

Freight Class: 100

V_346	36" X 24" X 29"	Cubic Ft: 18.8	Ship Weight: 197	1896	1924	1953
--------------	-----------------	----------------	------------------	-------------	-------------	-------------

Pulls:	Antique Brass A	Ebony E	Silver W
---------------	------------------------	----------------	-----------------

EXTRA THICK BOTTOM	\$160 H
---------------------------	----------------

Three Drawer Lateral File

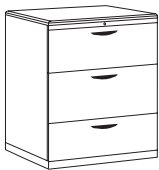

- Three lateral file drawers, letter or legal filing
- Central locking
- Anti-tilt mechanism inhibits more than one drawer opening at a time
- Hardwood bottom support rail secured with metal bracket at each end

Freight Class: 100

V_336	30.75" X 20" X 44.5"	Cubic Ft: 21.7	Ship Weight: 208	2337	2372	2407
--------------	----------------------	----------------	------------------	-------------	-------------	-------------

Pulls:	Antique Brass A	Ebony E	Silver W
---------------	------------------------	----------------	-----------------

EXTRA THICK BOTTOM	\$240 H
---------------------------	----------------

Four Drawer Lateral File

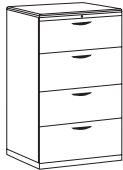

- Four lateral file drawers, letter or legal filing
- Central locking
- Anti-tilt mechanism inhibits more than one drawer opening at a time
- Hardwood bottom support rail secured with metal bracket at each end

Freight Class: 100

V_426	30.75" X 20" X 56"	Cubic Ft: 27.9	Ship Weight: 252	3138	3185	3232
--------------	--------------------	----------------	------------------	-------------	-------------	-------------

Pulls:	Antique Brass A	Ebony E	Silver W
---------------	------------------------	----------------	-----------------

EXTRA THICK BOTTOM	\$320 H
---------------------------	----------------

Three-Shelf Bookcase



- 1" thick shelves
- 48" bookcase= 2 adjustable shelves
- 36" bookcase= 1 adjustable shelf
- 29" bookcase= 1 adjustable shelf

Freight Class: 125

V_129	36" X 18" X 29"	Cubic Ft: 18.5	Ship Weight: 90	802	814	826
--------------	-----------------	----------------	-----------------	------------	------------	------------

V_36	36" X 18" X 36"	Cubic Ft: 18.5	Ship Weight: 90	856	869	882
-------------	-----------------	----------------	-----------------	------------	------------	------------

V_48	36" X 18" X 48"	Cubic Ft: 24.2	Ship Weight: 110	910	924	937
-------------	-----------------	----------------	------------------	------------	------------	------------

Five-Shelf Bookcase



- 1" thick shelves
- Two fixed shelves (middle and bottom)
- 65" & 72" bookcase= 3 adjustable shelves
- 84" bookcase= 4 adjustable shelves

Freight Class: 125

V_65	36" X 18" X 65.5"	Cubic Ft: 31.1	Ship Weight: 221	1040	1056	1071
-------------	-------------------	----------------	------------------	-------------	-------------	-------------

V_72	36" X 18" X 72"	Cubic Ft: 35.5	Ship Weight: 241	1177	1195	1212
-------------	-----------------	----------------	------------------	-------------	-------------	-------------

V_84	36" X 18" X 84"	Cubic Ft: 41.3	Ship Weight: 261	1336	1356	1376
-------------	-----------------	----------------	------------------	-------------	-------------	-------------

2-Door Bookcase

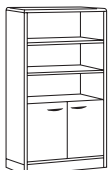

- Two adjustable shelves on top
- One fixed shelf above doors
- Two-door enclosed storage area with one adjustable shelf
- 1" thick shelves

Freight Class: 125

V_652D	36" X 18" X 65.5"	Cubic Ft: 31.9	Ship Weight: 230	1377	1398	1418
---------------	-------------------	----------------	------------------	-------------	-------------	-------------

Pulls:	Antique Brass A	Ebony E	Silver W
---------------	------------------------	----------------	-----------------

Overhead Storage Unit with Doors

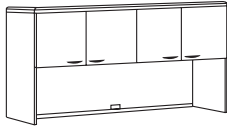

- Two storage compartments
- One wire management grommet
- 21" clearance under doors
- Includes task light standard

Freight Class: 125

				Zone Pricing	1	2	3
V_737	71" X 18" X 36.5"	Cubic Ft: 33.6	Ship Weight: 229		2183	2216	2248
V_677	65" X 18" X 36.5"	Cubic Ft: 28.3	Ship Weight: 198		2062	2093	2124

Pulls:	Antique Brass A	Ebony E	Silver W	Locks	\$150.00: Y
---------------	------------------------	----------------	-----------------	--------------	--------------------

Reception Screen for Main

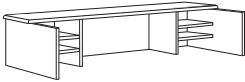

- Fits 66" x 30" desks
- Four adjustable shelves
- High gloss transaction counter top
- Non-skid rubber strips on bottom prohibit movement

Freight Class: 70

V_610	66" X 28" X 14"	Cubic Ft: 28.9	Ship Weight: 129		1317	1337	1357
--------------	-----------------	----------------	------------------	--	-------------	-------------	-------------

Reception Screen for Return



- Fits 48" x 24" executive height return
- Hardware included to join to main reception screen
- V_611L fits left return
- V_611R fits right return
- Assembly required

Freight Class: 70

V_611L	48" X 22" X 13"	Cubic Ft: 1.5	Ship Weight: 25		296	300	305
V_611R	48" X 22" X 13"	Cubic Ft: 1.5	Ship Weight: 25		296	300	305

Center Drawers

Center Drawer

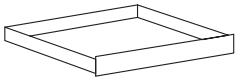

- V_28- Fits 72" single full pedestal desk or credenza or 66" double full pedestal desk
- V_29- Fits 72" single 3/4 pedestal desk or credenza
- V_34- Fits 72" double full pedestal desk or credenza
- V_38- Fits 72" double 3/4 pedestal desk or credenza

Freight Class: 100

V_38	38" X 19" X 3"	Cubic Ft: 2.2	Ship Weight: 13.5		179	182	184
V_34	34" X 19" X 3"	Cubic Ft: 2.2	Ship Weight: 13		179	182	184
V_29	29.75" X 19" X 3"	Cubic Ft: 1.5	Ship Weight: 12		165	167	170
V_28	28" X 19" X 3"	Cubic Ft: 1.5	Ship Weight: 11		165	167	170

Center Drawer

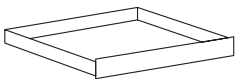

- V_28- Fits 72" single full pedestal desk or credenza or 66" double full pedestal desk
- V_32- Fits 66" double 3/4 pedestal desk or credenza
- V_22- Fits 66" single full pedestal desk or credenza
- V_24- Fits 66" single 3/4 pedestal desk or credenza

Freight Class: 100

V_28	28" X 19" X 3"	Cubic Ft: 1.5	Ship Weight: 11		165	167	170
V_32	32" X 19" X 3"	Cubic Ft: 2.2	Ship Weight: 12.2		179	182	184
V_22	22.5" X 19" X 3"	Cubic Ft: 1.5	Ship Weight: 10		165	167	170
V_24	23.75" X 19" X 3"	Cubic Ft: 1.5	Ship Weight: 10.5		165	167	170



FINISHES

Bedford is available in **Mahogany** and **Windsor Cherry** laminate.

PEDESTALS, CREDENZAS, FILE CABINETS AND STORAGE UNITS

All cases are $\frac{3}{4}$ " thick core surfaced on both sides with thermally fused laminate and edge banded as required. Units fully assembled with dowels/glue, wood cleats, metal brackets and screws. This series features picture frame molding on ends, backs and modesty panels. No molding on bridge. Series features full modesty panels.

TOPS

All tops are surfaced in **high-gloss, high pressure laminate** specifically chosen and color matched for this grouping. All bridge and return tops feature common grain direction with desk/credenza as well as reverse coped edges for smooth worksurface connection with desk/credenza. All tops are $1\frac{3}{16}$ " thick with solid hardwood edges and properly backed. All tops feature traditional detail on hardwood edges on all four sides with $\frac{3}{4}$ " overhang. Work surface dimensions will vary due to edge profile treatments.

DRAWERS

All drawer fronts are constructed of $\frac{3}{4}$ " thick core surfaced on both sides with melamine and edge banded as required. Drawer sides are $\frac{1}{2}$ " thick, grain printed in an oak finish. Drawer bottoms are $1/8$ " thick oak-grain hardboard.

- All box drawers are suspended on smooth action metal slides with ball bearings
- All file drawers and file cabinet drawers are mounted on heavy-duty ball bearing, full-extension slides
- Black filing hardware includes pre-installed rails with easy-adjust crossbar
- All file drawers allow letter filing front-to-back and letter or legal-size filing side-to-side
- All 38" lateral file drawers allow letter and/or legal filing front-to-back or legal size filing side-to-side
- 32" lateral file drawers allow legal filing side-to-side and letter filing front-to-back
- Maximum weight for bottom loading is 25 lb

- Drawers are constructed with 5 sides for extra strength and durability. The drawer front is the 5th side and is removable in the field for repairs or hardware additions

PEDESTALS

Supported on 4 leveling glides.

PANELS

Heavy-duty adjustable nylon leveling glides installed in each end panel. Modesty panels are $\frac{3}{4}$ " thick core.

TACK BOARDS

Fabric covered tackable boards may be ordered separately to fit inside hutches. They can be ordered with any fabric to match your office chairs except leather or vinyl.

BASES

All bases are 1" thick MDF surfaced with laminate.

WIRE MANAGEMENT

All grommets in the Bedford collection are rectangular $3\frac{1}{4}$ " x $1\frac{7}{8}$ " and made of black high impact poly resin. See features for number of grommets and location. Additional grommets can be added for extended wire management capability at \$106 list per grommet. Includes factory cut and installed grommet and black sleeve. **Specify location with order.**

HARDWARE

Pulls and knobs are a beautiful traditional design, solid metal antique brass finish.

LOCKS

- Independent fully locking pedestals are standard on all credenzas and desks.
- Two drawer lateral files feature individually locking drawers.
- Four drawer lateral files feature central locking and are keyed different than other locks due to the anti-tilt mechanism inside the unit.
- All locks are keyed identical unless otherwise specified.
- 'Key Different' option is \$21 list upcharge per lock. Locks/cores packaged to customer requirements.
- Additional lead time for 'Key Different'

ACCESSORIES *Factory Installed*

Certain accessories can be ordered installed prior to shipment. Add letter designator (C, K or T) at end of the desk, credenza or overhead model number:

- C** Center Drawer
Example: TRM3030C
- K** Keyboard Platform
Example: TRM3076LK
- T** Task Light
Example: TRM3071T

DIMENSIONS

All size dimensions are nominal and subject to change. If you must have exact dimensions, please contact your Customer Service Representative. Worksurface dimensions will vary due to edge profile treatment. Always measure actual top before ordering glass or other cover to fit tops.

QUICKSHIP

Quick Ship is not available on any items ordered with option.

PACKING

All units are properly packed in heavy duty cartons with heavy duty corner pads. All packaging conforms to or exceeds specifications as outlined in the Uniform Freight Classification.

All desks, credenzas, files, and overhead storage units are shipped assembled. Modular L-shaped, and U-shaped workstations are shipped in multiple cartons & require connection.

PALLETIZATION

See page 5.

CARE & CLEANING INSTRUCTIONS

Normal cleaning: Clean using a soft cloth and a good window cleaner which contains no ammonia, followed by wiping dry using a dry soft cloth.

Specifications subject to change without notice.

Configurations Zone Pricing

L-Shaped Workstation

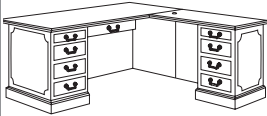

Description	Model Number	Qty	Frft. Class	Cubic Ft.	Ship Weight	1	2	3
Left Pedestal Desk	TR_3045ALH 66" x 30" x 29"	1	110	40.2	267	2285	2319	2354
Desk Height Right Return	TR_3048BRH 48" x 24" x 29"	1	110	25.3	178	1704	1730	1755
Total:				65.50	445	3989	4049	4109

66" x 78" x 29"

U-Shaped Workstation

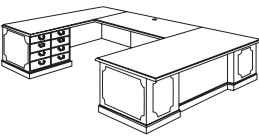

Description	Model Number	Qty	Frft. Class	Cubic Ft.	Ship Weight	1	2	3
Right Pedestal Desk	TR_3048ARH 72" x 36" x 29"	1	110	51.6	308	2767	2809	2850
Desk Height Bridge	TR_3041 48" x 24" x 29"	1	100	4.0	89	729	740	751
Left Twin Pedestal Credenza	TR_3075L 72" x 24" x 29"	1	125	35.7	277	2421	2457	2494
Total:				91.30	674	5917	6006	6095

72" x 108" x 29"

U-Shaped Workstation

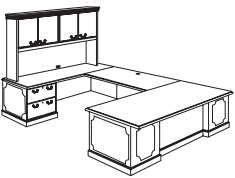

Description	Model Number	Qty	Frft. Class	Cubic Ft.	Ship Weight	1	2	3
Right Pedestal Desk	TR_3048ARH 72" x 36" x 29"	1	110	51.6	308	2767	2809	2850
Desk Height Bridge	TR_3041 48" x 24" x 29"	1	100	4.0	89	729	740	751
Left Lateral File Credenza	TR_3033L 72" x 24" x 29"	1	125	35.7	254	2390	2426	2462
Overhead Storage Unit	TR_3071 72" x 16" x 48"	1	125	43.6	261	1866	1894	1922
Total:				134.90	912	7752	7869	7985

72" x 108" x 77"

Desks

Double Pedestal Bow Front Desk



- Pencil/box/file drawer configuration
- Legal or letter filing
- Two pullout writing shelves
- Individually locking pedestals

TR_3030B QS 72" X 36" X 29" Cubic Ft: 51.6 Ship Weight: 333	2890	2933	2977
Center Drawer C	176	179	181
Keyboard Platform K	193	196	199

Freight Class: 110

QS FINISHES M

Left Pedestal Bow Front Desk



- Pencil/box/file drawer configuration
- Legal or letter filing
- One pullout writing shelf
- Locking pedestal
- Center drawer standard
- Extra open storage pedestal on connecting side with two grommets

TR_30721LB 72" X 36" X 29" Cubic Ft: 51.6 Ship Weight: 296	2941	2985	3029
---	-------------	-------------	-------------

Freight Class: 110

Right Pedestal Bow Front Desk



- Pencil/box/file drawer configuration
- Legal or letter filing
- One pullout writing shelf
- Locking pedestal
- Center drawer standard
- Extra open storage pedestal on connecting side with two grommets

TR_30721RB 72" X 36" X 29" Cubic Ft: 51.6 Ship Weight: 296	2941	2985	3029
---	-------------	-------------	-------------

Freight Class: 110

TRADITIONAL LAMINATE



Zone Pricing	1	2	3
--------------	---	---	---

Double Pedestal Desk



- Two pencil drawers
- Two box drawers
- Two file drawers
- Pre-installed filing hardware for letter or legal filing
- Two pullout writing shelves
- Individually locking pedestals

TR_3020	QS	60" X 30" X 29" Cubic Ft: 36.7 Ship Weight: 300	2501	2539	2576
		Center Drawer C	162	164	167
		Keyboard Platform K	193	196	199
TR_3025	QS	66" X 30" X 29" Cubic Ft: 40.2 Ship Weight: 326	2677	2717	2757
		Center Drawer C	176	179	181
		Keyboard Platform K	193	196	199
TR_3030	QS	72" X 36" X 29" Cubic Ft: 51.6 Ship Weight: 346	2748	2789	2830
		Center Drawer C	176	179	181
		Keyboard Platform K	193	196	199
QS FINISHES		M			

Freight Class: 110

Left Pedestal Desk



- Pencil/box/file pedestal on left
- Pre-installed filing hardware for letter or legal filing
- One pullout writing shelf
- Locking pedestal
- Center drawer standard
- Extra open storage pedestal on connecting side with two grommets

TR_3045ALH	QS	66" X 30" X 29" Cubic Ft: 40.2 Ship Weight: 267	2285	2319	2354
TR_3048ALH	QS	72" X 36" X 29" Cubic Ft: 51.6 Ship Weight: 308	2767	2809	2850
QS FINISHES		M			

Freight Class: 110

Right Pedestal Desk

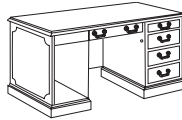

- Pencil/box/file pedestal on right
- Pre-installed filing hardware for letter or legal filing
- One pullout writing shelf
- Locking pedestal
- Center drawer standard
- Extra open storage pedestal on connecting side with two grommets

TR_3045ARH	QS	66" X 30" X 29" Cubic Ft: 40.2 Ship Weight: 267	2285	2319	2354
TR_3048ARH	QS	72" X 36" X 29" Cubic Ft: 51.6 Ship Weight: 308	2767	2809	2850
QS FINISHES		M			

Freight Class: 110

Credenzas

Executive Storage Credenza



- Two pencil/box/file drawer pedestals
- Pre-installed filing hardware for letter or legal filing
- Individually locking pedestals
- Storage compartment with one adjustable shelf behind two hinged doors, center

TR_3072	QS	72" X 24" X 29" Cubic Ft: 35.7 Ship Weight: 316	2830	2872	2915
QS FINISHES		M			

Freight Class: 125

Computer Credenza



- Two pencil/box/file drawer pedestals
- Pre-installed filing hardware for letter or legal filing
- Individually locking pedestals
- Pullout keyboard platform standard on TR_3064
- Keyboard drawer with flip down front standard on TR_3074
- One grommet in modesty panel

TR_3064	QS	66" X 24" X 29" Cubic Ft: 32.8 Ship Weight: 268	2585	2624	2663
TR_3074	QS	72" X 24" X 29" Cubic Ft: 35.7 Ship Weight: 302	2622	2661	2701
QS FINISHES		M			

Freight Class: 110





Right Computer Credenza

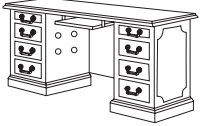
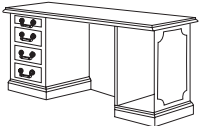
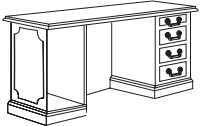

- CPU storage right pedestal
- Pencil/box/file drawer left pedestal
- Pre-installed filing hardware for letter or legal filing
- One grommet in back and four in inside panel of CPU storage pedestal
- Pullout keyboard platform standard
- Locking pedestal with drawers

TR_CPR744		72" X 24" X 29" Cubic Ft: 35.7 Ship Weight: 287	2622	2661	2701
------------------	--	---	-------------	-------------	-------------

Freight Class: 110

		Zone Pricing	1	2	3
 <p>Left Computer Credenza</p> <ul style="list-style-type: none"> • CPU storage left pedestal • Pencil/box/file drawer right pedestal • Pre-installed filing hardware for letter or legal filing • One grommet in back and four in inside panel of CPU storage pedestal • Pullout keyboard platform standard • Locking pedestal with drawers <p>Freight Class: 110</p>	TR_CPL744	72" X 24" X 29" Cubic Ft: 35.7 Ship Weight: 287	2622	2661	2701
 <p>Left Pedestal Credenza</p> <ul style="list-style-type: none"> • Two file drawers • Pre-installed filing hardware for letter or legal filing • Single key side locking • One grommet in modesty panel • Extra open storage pedestal on connecting side with two grommets <p>Freight Class: 125</p>	TR_3076L QS	72" X 24" X 29" Cubic Ft: 35.7 Ship Weight: 200	2057	2088	2119
			Keyboard Platform K	193	196
	TR_3064L	66" X 24" X 29" Cubic Ft: 32.8 Ship Weight: 182	1753	1779	1806
		Keyboard Platform K	193	196	199
QS FINISHES M					
 <p>Right Pedestal Credenza</p> <ul style="list-style-type: none"> • Two file drawers • Pre-installed filing hardware for letter or legal filing • Single key side locking • One grommet in modesty panel • Extra open storage pedestal on connecting side with two grommets <p>Freight Class: 125</p>	TR_3076R QS	72" X 24" X 29" Cubic Ft: 35.7 Ship Weight: 200	2057	2088	2119
			Keyboard Platform K	193	196
	TR_3064R	66" X 24" X 29" Cubic Ft: 32.8 Ship Weight: 182	1753	1779	1806
		Keyboard Platform K	193	196	199
QS FINISHES M					
 <p>Storage Credenza</p> <ul style="list-style-type: none"> • Two hinged doors • Storage compartment with one adjustable shelf <p>Freight Class: 125</p>	TR_3042 QS	38" X 24" X 29" Cubic Ft: 19.5 Ship Weight: 140	1305	1325	1344
	QS FINISHES M				
 <p>Left Twin Pedestal Credenza</p> <ul style="list-style-type: none"> • Two pencil drawers • Two box drawers • Two file drawers • Pre-installed filing hardware for letter or legal filing • Lock on inside pedestal only • One grommet in modesty panel • Extra open storage pedestal on connecting side with two grommets <p>Freight Class: 125</p>	TR_3075L QS	72" X 24" X 29" Cubic Ft: 35.7 Ship Weight: 277	2421	2457	2494
	QS FINISHES M				
 <p>Right Twin Pedestal Credenza</p> <ul style="list-style-type: none"> • Two pencil drawers • Two box drawers • Two file drawers • Pre-installed filing hardware for letter or legal filing • Lock on inside pedestal only • One grommet in modesty panel • Extra open storage pedestal on connecting side with two grommets <p>Freight Class: 125</p>	TR_3075R QS	72" X 24" X 29" Cubic Ft: 35.7 Ship Weight: 277	2421	2457	2494
	QS FINISHES M				
 <p>Left Lateral File Credenza</p> <ul style="list-style-type: none"> • Two lateral file drawers • Pre-installed filing hardware for letter or legal filing • Side locking • Extra open storage pedestal on connecting side with two grommets • One grommet in modesty panel <p>Freight Class: 125</p>	TR_3033L	72" X 24" X 29" Cubic Ft: 35.7 Ship Weight: 254	2390	2426	2462
					EXTRA THICK BOTTOM



Zone Pricing	1	2	3
--------------	---	---	---

Right Lateral File Credenza

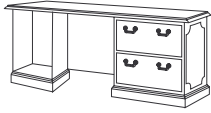

- Two lateral file drawers
- Pre-installed filing hardware for letter or legal filing
- Side locking
- Extra open storage pedestal on connecting side with two grommets
- One grommet in modesty panel

Freight Class: 125

TR_3033R	72" X 24" X 29"	Cubic Ft: 35.7	Ship Weight: 254	2390	2426	2462
-----------------	-----------------	----------------	------------------	-------------	-------------	-------------

EXTRA THICK BOTTOM	\$160 H
---------------------------	----------------

Double Lateral File Credenza



- Four lateral file drawers
- Pre-installed filing hardware for letter or legal filing
- Side locking

Freight Class: 125

TR_733	73.75" X 24" X 29"	Cubic Ft: 35.7	Ship Weight: 368	3247	3296	3344
---------------	--------------------	----------------	------------------	-------------	-------------	-------------

EXTRA THICK BOTTOM	\$320 H
---------------------------	----------------

Double Bookcase Credenza



- Two bookcase compartments
- One adjustable shelf in each compartment

Freight Class: 125

TR_734	72" X 24" X 29"	Cubic Ft: 35.7	Ship Weight: 340	2337	2372	2407
---------------	-----------------	----------------	------------------	-------------	-------------	-------------

Returns & Bridges

Left Desk Height Return



- One pencil/box/file drawer pedestal
- Pre-installed filing hardware for letter or legal filing
- One grommet in modesty panel
- Reverse coped edge for smooth connection
- Common grain direction with desk/credenzas

Freight Class: 110

TR_3048BLH QS	48" X 24" X 29"	Cubic Ft: 25.3	Ship Weight: 178	1704	1730	1755
----------------------	-----------------	----------------	------------------	-------------	-------------	-------------

Keyboard Platform K	193	196	199
----------------------------	-----	-----	-----

TR_3040BLH	42" X 24" X 29"	Cubic Ft: 21.8	Ship Weight: 158	1688	1713	1739
-------------------	-----------------	----------------	------------------	-------------	-------------	-------------

Keyboard Platform K	193	196	199
----------------------------	-----	-----	-----

TR_3452L	36" X 24" X 29"	Cubic Ft: 21.8	Ship Weight: 138	1684	1709	1735
-----------------	-----------------	----------------	------------------	-------------	-------------	-------------

QS FINISHES	M
--------------------	----------

Right Desk Height Return



Freight Class: 110

TR_3048BRH QS	48" X 24" X 29"	Cubic Ft: 25.3	Ship Weight: 178	1704	1730	1755
----------------------	-----------------	----------------	------------------	-------------	-------------	-------------

Keyboard Platform K	193	196	199
----------------------------	-----	-----	-----

TR_3040BRH	42" X 24" X 29"	Cubic Ft: 21.8	Ship Weight: 158	1688	1713	1739
-------------------	-----------------	----------------	------------------	-------------	-------------	-------------

Keyboard Platform K	193	196	199
----------------------------	-----	-----	-----

TR_3452R	36" X 24" X 29"	Cubic Ft: 21.8	Ship Weight: 138	1684	1709	1735
-----------------	-----------------	----------------	------------------	-------------	-------------	-------------

QS FINISHES	M
--------------------	----------

Desk Height Bridge

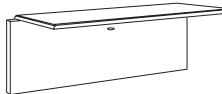

Freight Class: 100

- Use with single pedestal desks and/or credenzas
- Common grain direction with desks/credenzas
- Reverse coped edge on connecting sides
- One wire management grommet in modesty panel

TR_3041 QS	48" X 24" X 29"	Cubic Ft: 4	Ship Weight: 89	729	740	751
-------------------	-----------------	-------------	-----------------	------------	------------	------------

TR_3040 QS	42" X 24" X 29"	Cubic Ft: 4	Ship Weight: 80	679	689	699
-------------------	-----------------	-------------	-----------------	------------	------------	------------

QS FINISHES	M
--------------------	----------

Files, Overheads, Bookcases & Storage

Two Drawer File



Freight Class: 100

- Two file drawers
- Pre-installed filing hardware for letter or legal filing
- Side locking

TR_302DF QS	18" X 24" X 29"	Cubic Ft: 10	Ship Weight: 111	1297	1316	1336
--------------------	-----------------	--------------	------------------	-------------	-------------	-------------

QS FINISHES	M
--------------------	----------

Zone Pricing	1	2	3
--------------	---	---	---

Standard Lateral File



- Two lateral file drawers
- Pre-installed filing hardware for letter or legal filing
- Side locking
- Anti-tilt mechanism inhibits more than one drawer opening at one time

Freight Class: 100

TR_3026DF QS	32" X 21.5" X 29" Cubic Ft: 14 Ship Weight: 152	1410	1431	1452
---------------------	---	-------------	-------------	-------------

QS FINISHES	M
--------------------	----------

EXTRA THICK BOTTOM	\$160 H
---------------------------	----------------

Executive Lateral File



- Two lateral file drawers
- Pre-installed filing hardware for letter or legal filing
- Side locking
- Anti-tilt mechanism inhibits more than one drawer opening at one time

Freight Class: 100

TR_3032DF QS	38" X 24" X 29" Cubic Ft: 19.5 Ship Weight: 183	1693	1718	1744
---------------------	---	-------------	-------------	-------------

QS FINISHES	M
--------------------	----------

EXTRA THICK BOTTOM	\$160 H
---------------------------	----------------

Three Drawer Lateral File



- Three lateral file drawers
- Pre-installed filing hardware for letter or legal filing
- Central locking
- Anti-tilt mechanism inhibits more than one drawer opening at one time

Freight Class: 125

TR_3036DF QS	32" X 21.5" X 44 5" Cubic Ft: 27.9 Ship Weight: 219	2313	2348	2382
---------------------	---	-------------	-------------	-------------

QS FINISHES	M
--------------------	----------

EXTRA THICK BOTTOM	\$240 H
---------------------------	----------------

Four Drawer Lateral File



- Four lateral file drawers
- Pre-installed filing hardware for letter or legal filing
- Central locking
- Anti-tilt mechanism inhibits more than one drawer opening at one time

Freight Class: 125

TR_4026DF QS	32" X 21.5" X 56" Cubic Ft: 27.9 Ship Weight: 252	2753	2794	2836
---------------------	---	-------------	-------------	-------------

QS FINISHES	M
--------------------	----------

EXTRA THICK BOTTOM	\$320 H
---------------------------	----------------

Single Hutch



- Three adjustable shelves
- One wire management grommet in back panel
- Fits 38" wide executive lateral file (TR_3032DF)

Freight Class: 125

TR_3066 QS	36" X 16" X 48" Cubic Ft: 22.9 Ship Weight: 108	924	938	952
-------------------	---	------------	------------	------------

QS FINISHES	M
--------------------	----------

Double Hutch



- Six adjustable shelves
- Two wire management grommets in back panel
- Fits 72" wide credenzas

Freight Class: 125

TR_3068 QS	72" X 16" X 48" Cubic Ft: 43.6 Ship Weight: 207	1809	1836	1863
-------------------	---	-------------	-------------	-------------

QS FINISHES	M
--------------------	----------

Overhead Storage Unit



- Two storage compartments
- One wire management grommet in back panel
- 25-1/4" clearance under doors
- Fits 72" wide credenzas
- Tackboard available

Freight Class: 125

TR_3071 QS	72" X 16" X 48" Cubic Ft: 43.6 Ship Weight: 261	1866	1894	1922
-------------------	---	-------------	-------------	-------------

QS FINISHES	M
--------------------	----------

Task Light T	124	126	128
---------------------	-----	-----	-----

TR_3077	66" X 16" X 48" Cubic Ft: 43.6 Ship Weight: 245	1613	1637	1661
----------------	---	-------------	-------------	-------------

Locks	\$150: Y
--------------	-----------------

Task Light T	124	126	128
---------------------	-----	-----	-----

Two-Shelf Bookcase



- One adjustable and one fixed shelf
- 1" thick shelf
- Crown molding on three sides

Freight Class: 125

TR_B36	36" X 16" X 36" Cubic Ft: 15.4 Ship Weight: 91	798	810	822
---------------	--	------------	------------	------------



Zone Pricing	1	2	3
--------------	---	---	---

Bookcase Storage with Two Doors



- One adjustable shelf
- 1" thick shelf
- Two doors
- Crown molding on three sides

Freight Class: 125

TR_362D	36" X 16" X 36" Cubic Ft: 15.4 Ship Weight: 125	993	1008	1023
----------------	---	------------	-------------	-------------

Three Shelf Bookcase



- Two adjustable shelves
- 1" thick shelf
- Crown molding on three sides

Freight Class: 125

TR_B52	QS 36" X 16" X 52" Cubic Ft: 22.5 Ship Weight: 134	881	894	907
---------------	---	------------	------------	------------

QS FINISHES M

Five Shelf Bookcase



- Three adjustable shelves
- Two fixed shelves (middle and bottom)
- 1" thick shelves
- Crown molding on three sides

Freight Class: 125

TR_B76	QS 36" X 16" X 77" Cubic Ft: 31.9 Ship Weight: 185	1205	1223	1241
---------------	---	-------------	-------------	-------------

QS FINISHES M

Two Door Bookcase



- Two door storage area
- Two adjustable shelves on top
- One fixed shelf (above doors)
- One adjustable shelf in cabinet
- 1" thick shelves
- Crown molding on three sides

Freight Class: 125

TR_762D	QS 36" X 16" X 77" Cubic Ft: 31.9 Ship Weight: 218	1403	1424	1445
----------------	---	-------------	-------------	-------------

QS FINISHES M

Bookcase Wall Unit



- Three adjustable shelves
- 1" thick shelves
- Two fixed shelves (middle and bottom)
- TR_W72 prebored and includes fittings to make flush connection to add-on units
- TR_W72NH is not prebored
- Crown molding on front only

Freight Class: 125

TR_W72	QS 34" X 16" X 72" Cubic Ft: 30.3 Ship Weight: 176	1099	1115	1132
---------------	---	-------------	-------------	-------------

TR_W72NH	34" X 16" X 72" Cubic Ft: 30.3 Ship Weight: 176	1099	1115	1132
-----------------	---	-------------	-------------	-------------

QS FINISHES M

Two Door Bookcase Wall Unit



- Two door enclosed storage area
- Two adjustable shelves on top
- One fixed shelf (above doors)
- One adjustable shelf in cabinet
- TR_W722D prebored and includes fittings to make flush connection to add-on units
- TR_W722DNH is not prebored
- 1" thick shelves
- Crown molding on front only

Freight Class: 125

TR_W722D	QS 34" X 16" X 72" Cubic Ft: 30.3 Ship Weight: 208	1326	1346	1366
-----------------	---	-------------	-------------	-------------

TR_W722DNH	34" X 16" X 72" Cubic Ft: 30.3 Ship Weight: 208	1326	1346	1366
-------------------	---	-------------	-------------	-------------

QS FINISHES M

Storage Cabinet



- Storage cabinet with four full-width adjustable shelves behind two full height doors
- Crown molding on three sides

Freight Class: 125

TR_76DS	36" X 24" X 77" Cubic Ft: 48 Ship Weight: 309	2132	2164	2196
----------------	---	-------------	-------------	-------------

TR_MB Marker Board

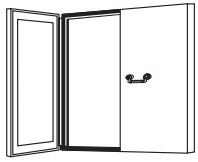

- Marker board 45" x 42" inside
- Eraser and market kit included
- Reverse-side of doors feature grey fabric-covered tackable surface
- Magnetic door catches
- Optional pre-installed projection screen; add P to model number- see below for pricing

Freight Class: 100

			Zone Pricing		
			1	2	3
TR_MB	48" x 4.5" x 48	Cubic Ft: 12.2 Ship Weight: 141	1290	1309	1329

Projection Screen

- Roll down projection screen fits inside Marker Board
- Requires removal of fascia board for installation
- Must be factory-installed

Freight Class: 100

PROJECTSCREEN	40" x 48"	Cubic Ft: 1.21 Ship Weight: 5	157	159	162
----------------------	-----------	-------------------------------	------------	------------	------------

Multi-Use Wardrobe/Storage



- Two door storage area
- Coat rod mounted in left side
- Four adjustable shelves in right
- Both sides drilled for adjustable shelves
- Individually locking doors
- Crown molding on three sides

Freight Class: 125

TR_76DWD	36" X 24" X 77"	Cubic Ft: 48 Ship Weight: 309	2296	2330	2365
-----------------	-----------------	-------------------------------	-------------	-------------	-------------

Reception Screens & Tables

Reception Screen for Main

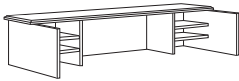

- TR_3010 - Fits 66" x 30" desks
- TR_3009 - Fits 72" x 36" desks
- Non-skid rubber strips on bottom prohibits movement
- Four adjustable shelves

Freight Class: 70

TR_3010 QS	66" X 28" X 14"	Cubic Ft: 28.9 Ship Weight: 129	1151	1168	1186
TR_3009	72" X 36" X 14"	Cubic Ft: 31.9 Ship Weight: 139	1511	1534	1556

QS FINISHES M

Reception Screen for Return



- Fits 48" x 24" executive height return
- Hardware included to join to main reception screen
- TR_3011L fits left return
- TR_3011R fits right return
- Assembly required

Freight Class: 70

TR_3011L QS	48" X 22" X 13"	Cubic Ft: 1.5 Ship Weight: 25	263	267	271
TR_3011R QS	48" X 22" X 13"	Cubic Ft: 1.5 Ship Weight: 25	263	267	271

QS FINISHES M

Traditional Cocktail Table

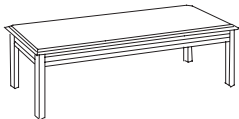

- High-gloss, high pressure laminate top in Mahogany and Windsor Cherry
- Shaped edges
- Ships unassembled, easy assembly

Freight Class: 100

TR_4020 QS	54" X 24" X 16"	Cubic Ft: 5.5 Ship Weight: 69.5	833	845	858
-------------------	-----------------	---------------------------------	------------	------------	------------

QS FINISHES M

Finish Options: Mahogany (M), Windsor Cherry (WC)

Traditional End Table

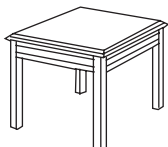

- High-gloss, high pressure laminate top in Mahogany and Windsor Cherry
- Shaped edges
- Ships unassembled, easy assembly

Freight Class: 92.5

TR_4023 QS	22" X 27" X 18"	Cubic Ft: 2.5 Ship Weight: 38	689	699	710
-------------------	-----------------	-------------------------------	------------	------------	------------

QS FINISHES M

Finish Options: Mahogany (M), Windsor Cherry (WC)



Center Drawers & Keyboard Platforms

Zone Pricing	1	2	3
--------------	---	---	---

Center Drawer

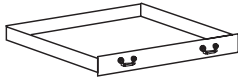

- TR_29 Fits 60" double pedestal desks
- TR_30 Fits 72" double pedestal desks
- TR_32 Fits 66" double pedestal desks

TR_29 QS	26.75" X 18.75" X 3.75" Cubic Ft: 1.5 Ship Weight: 12	162	164	167
TR_30 QS	38.75" X 18.75" X 3.75" Cubic Ft: 2.2 Ship Weight: 13	176	179	181
TR_32 QS	32.75" X 18.75" X 3.75" Cubic Ft: 2.2 Ship Weight: 13	176	179	181

QS FINISHES M

Freight Class: 100

Keyboard Platform

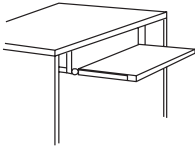

- Requires a 26" kneespace for installation
- Platform only, does not include table

TR_3096 QS	21" X 18" Cubic Ft: 1.5 Ship Weight: 12	193	196	199
-------------------	---	------------	------------	------------

QS FINISHES M

Freight Class: 92.5

UNIT	KNEESPACE	OVERHANG
72" Double Pedestal Desk	39"	8-1/2"
66" Double Pedestal Desk	33"	2-1/2"
60" Double Pedestal Desk	27"	2-1/2"
72" Double Pedestal Credenza	39"	n/a
60" Double Pedestal Credenza	27"	n/a
60" Double Pedestal Credenza	27"	3/4"

FINISHES

Wyndham is available in Mahogany and Windsor Cherry finishes. All finishes are thermally fused laminates unless otherwise noted. A high pressure, high gloss laminate top option is available for a 15% pricing upcharge. A six-week lead time will apply. High pressure laminate tops are only offered in Windsor Cherry and Mahogany. Contact your customer service representative to discuss specific high pressure laminate needs and delivery quotes. To order high pressure laminate tops in Windsor Cherry or Mahogany add T before the WY and add 15% to the list price of the item.

Example: TWYM601

CONSTRUCTION: *Pedestals, Credenzas, File Cabinets and Storage Units:* All cases are ¾" thick core surfaced on the outside with laminate and edge banded as required. Units fully assembled with dowels/glue, wood cleats, metal brackets and screws. Series features full modesty panels. This series features picture frame molding on ends and backs. There is no molding on modesty panels or bridge. Series features full modesty panels.

TOPS

All tops are 1" thick MDF surfaced in thermally fused laminate and are properly backed. All bridge and return tops feature common grain direction with desk/credenza as well as reverse coped edges for smooth work surface connection with desk/credenza. Work surface dimensions will vary due to edge profile.

DRAWERS

All drawer fronts are constructed of ¾" thick core with thermally fused laminate on both sides and edge banded as required. Drawer sides are ½" thick, oak grained pattern. Drawer bottoms are 1/8" thick oak-grain hardboard.

- All box drawers are suspended on smooth-action metal slides with ball bearings
- All file drawers and file cabinet drawers are mounted on heavy-duty ball bearing, full-extension slides
- Black filing hardware includes pre-installed rails with easy-adjust crossbar
- All file drawers allow letter filing, front-to-back and legal size filing side-to-side
- All 38" lateral file drawers allow letter and/or legal filing front-to-back or legal size filing side-to-side

- 32" lateral file drawers allow legal filing side-to-side and letter filing front-to-back
- Maximum weight for bottom loading is 25 lb
- Drawers are constructed with 5 sides for extra strength and durability. The drawer front is the 5th side and is removable in the field for repairs or hardware additions

PEDESTALS

Supported with 4 leveling glides in steel plates.

PANELS

Heavy-duty adjustable nylon leveling glides in steel plate are installed in each 1" thick end panel. Modesty panels are ¾" thick core.

BASES

All bases are 1" thick fiberboard surfaced with melamine.

WIRE MANAGEMENT

All grommets in the Wyndham collection are rectangular 3 1/4" x 1 7/8" and made of black high impact poly resin. See features for number of grommets and location. Additional grommets can be added for extended wire management capability at \$106 list per grommet. Includes factory cut and installed grommet and black sleeve. Specify location with order.

HARDWARE

Pulls and knobs are a beautiful traditional design, solid metal, with a brass finish to complement the Wyndham collection.

TACK BOARDS

Fabric covered tackable boards may be ordered separately to fit inside hutches. They can be ordered with any fabric to match your office chairs except leather or vinyl.

LOCKS

- Independent fully locking pedestals are standard on all desks and credenzas
- Two drawer and four drawer lateral files are central locking
- Four drawer lateral files feature central locking and are keyed different than other locks due to the anti-tilt mechanism inside the unit
- All locks are keyed identical unless otherwise specified
- 'Key Different' option is \$21 list upcharge per lock. Locks/cores packaged to customer requirements
- Additional lead time for 'Key Different'

ACCESSORIES *Factory Installed*

Certain accessories can be ordered installed prior to shipment. Add letter designator (C, K or T) at end of the desk, credenza or overhead model number:

- C** Center Drawer
Example: WYM651RC
- K** Keyboard Platform
Example: WYM604K
- T** Task Light
Example: WYM737T

DIMENSIONS

All size dimensions are nominal and subject to change. If you must have exact dimensions, please contact your Customer Service Representative. Worksurface dimensions will vary due to edge profile treatment. Always measure actual top before ordering glass or other cover to fit tops.

QUICKSHIP

Quick Ship is not available on any items ordered with option.

PACKING

All units are properly packed in heavy duty cartons with heavy duty corner pads. All packaging conforms to or exceeds specifications as outlined in the Uniform Freight Classification. All desks, credenzas, files, and overhead storage units are shipped set up. Modular L-shaped, and U-shaped workstations are shipped in multiple cartons and require connection in the field.

PALLETIZATION

See page 5.

CARE & CLEANING INSTRUCTIONS

Normal cleaning: Clean using a soft cloth and a good window cleaner which contains no ammonia, followed by wiping dry using a dry soft cloth.

Specifications subject to change without notice.

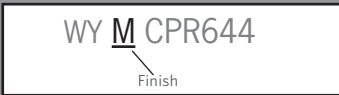

Configurations

Zone Pricing	1	2	3
--------------	---	---	---

L-Shaped Workstation

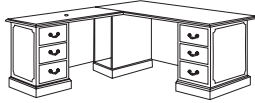

Description	Model Number	Qty	Frft.Class	Cubic Ft.	Ship Weight				
Right Pedestal Desk	WY_651R 66" x 30" x 29"	1	110	40.2	246	1680	1705	1730	
Desk Height Left Return	WY_722L 48" x 24" x 29"	1	110	24.3	152	1359	1379	1400	
Total:							3039	3084	3130

66" x 78" x 29"

U-Shaped Workstation

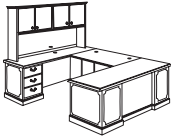

Description	Model Number	Qty	Frft.Class	Cubic Ft.	Ship Weight				
Right Pedestal Desk	WY_651R 66" x 30" x 29"	1	110	40.2	246	1680	1705	1730	
Desk Height Bridge	WY_485 48" x 24" x 29"	1	100	4.0	67	684	694	705	
Left Pedestal Credenza	WY_625L 66" x 24" x 29"	1	125	32.8	202	1739	1765	1791	
Overhead Storage Unit	WY_677 66" x 19" x 37"	1	125	30.1	193	1638	1663	1687	
Total:							5741	5827	5913

66" x 102" x 66"

Desks

Double Pedestal Desk



- Two box drawers
- Two file drawers
- Pre-installed filing hardware for letter or legal filing
- Individual locking pedestals

Freight Class: 110

WY_601	QS	60" X 30" X 29"	Cubic Ft: 36.7	Ship Weight: 264	1909	1938	1966	
					Center Drawer C	149	151	153
WY_659	QS	66" X 30" X 29"	Cubic Ft: 40.2	Ship Weight: 277	1957	1986	2016	
					Center Drawer C	163	165	168
WY_719	QS	72" X 36" X 29"	Cubic Ft: 51.6	Ship Weight: 303	2110	2142	2173	
					Center Drawer C	163	165	168

QS FINISHES **M**

Left Pedestal Desk



- One box drawer
- One file drawer
- Pre-installed filing hardware for letter or legal filing
- Locking pedestals
- Extra open storage pedestal on connecting side with two grommets

Freight Class: 110

WY_651L	QS	66" X 30" X 29"	Cubic Ft: 40.2	Ship Weight: 246	1680	1705	1730	
					Center Drawer C	149	151	153
WY_700L		72" X 30" X 29"	Cubic Ft: 44.4	Ship Weight: 256	1815	1842	1869	
					Center Drawer C	149	151	153
WY_721L		72" X 36" X 29"	Cubic Ft: 51.6	Ship Weight: 265	1879	1907	1935	
					Center Drawer C	149	151	153

QS FINISHES **M**

Right Pedestal Desk

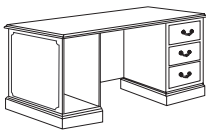

- One box drawer
- One file drawer
- Pre-installed filing hardware for letter or legal filing
- Locking pedestals
- Extra open storage pedestal on connecting side with two grommets

Freight Class: 110

WY_651R	QS	66" X 30" X 29"	Cubic Ft: 40.2	Ship Weight: 246	1680	1705	1730	
					Center Drawer C	149	151	153
WY_700R		72" X 30" X 29"	Cubic Ft: 44.4	Ship Weight: 256	1815	1842	1869	
					Center Drawer C	149	151	153
WY_721R		72" X 36" X 29"	Cubic Ft: 51.6	Ship Weight: 265	1879	1907	1935	
					Center Drawer C	149	151	153

QS FINISHES **M**

UNIT	KNEESPACE	OVERHANG
72" Double Pedestal Desk	39"	6-1/2"
66" Double Pedestal Desk	33"	2-1/2"
60" Double Pedestal Desk	27"	2-1/2"
72" Double Pedestal Credenza	39"	n/a
66" Double Pedestal Credenza	33"	n/a

Credenzas

Zone Pricing

1

2

3

Computer Credenza with CPU Storage



- CPU storage pedestal on hand side of unit
- Box/File pedestal on other side
- Pre-installed filing hardware for letter or legal filing
- Pullout keyboard platform standard
- Locking drawer pedestal
- One grommet in modesty, four in inside panel of CPU pedestal

WY_CPL644	66" X 24" X 29"	Cubic Ft: 32.8	Ship Weight: 223	1864	1892	1920
WY_CPR644	66" X 24" X 29"	Cubic Ft: 32.8	Ship Weight: 223	1864	1892	1920
WY_CPL744	72" X 24" X 29"	Cubic Ft: 40.2	Ship Weight: 246	1973	2003	2032
WY_CPR744	72" X 24" X 29"	Cubic Ft: 40.2	Ship Weight: 246	1973	2003	2032

Freight Class: 110

Computer Credenza



- Two box drawers
- Two file drawers, letter or legal filing
- Individual locking pedestals
- Pullout keyboard platform standard on WY_744
- One grommet in modesty panel

WY_604	QS	66" X 24" X 29"	Cubic Ft: 32.8	Ship Weight: 235	1864	1892	1920	
					Keyboard Platform K	199	202	205
WY_744	QS	72" X 24" X 29"	Cubic Ft: 40.2	Ship Weight: 255	1973	2003	2032	

QS FINISHES M

Freight Class: 110

Computer Credenza



- Two box drawers
- Two file drawers, letter or legal filing
- Extra wide keyboard drawer with flip down front
- Individual locking pedestals
- One grommet in modesty panel

WY_645DK	66" X 24" X 29"	Cubic Ft: 32.8	Ship Weight: 259	2130	2162	2194
WY_745DK	72" X 24" X 29"	Cubic Ft: 40.2	Ship Weight: 270	2431	2467	2504

Freight Class: 110

Single Pedestal Credenza



Left

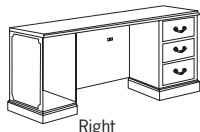

Right

- One box drawer
- One file drawer, letter or legal filing
- One grommet in modesty panel

- Locking pedestal
- Extra open storage pedestal on connecting side with two grommets

WY_625L	QS	66" X 24" X 29"	Cubic Ft: 32.8	Ship Weight: 202	1739	1765	1791	
					Keyboard Platform K	196	199	202
WY_725L		72" X 24" X 29"	Cubic Ft: 40.2	Ship Weight: 218	1860	1888	1916	
					Keyboard Platform K	196	199	202
WY_625R	QS	66" X 24" X 29"	Cubic Ft: 32.8	Ship Weight: 202	1739	1765	1791	
					Keyboard Platform K	196	199	202
WY_725R		72" X 24" X 29"	Cubic Ft: 40.2	Ship Weight: 218	1860	1888	1916	
					Keyboard Platform K	196	199	202

QS FINISHES M

Freight Class: 125

Storage Credenza



- Two box drawers
- Two file drawers, letter or legal filing
- Individual locking pedestals
- Storage compartment with one adjustable shelf
- Two hinged doors

WY_672	66" X 24" X 29"	Cubic Ft: 32.8	Ship Weight: 278	2220	2253	2287
WY_704	72" X 24" X 29"	Cubic Ft: 40.2	Ship Weight: 298	2448	2485	2521

Freight Class: 125

Double Lateral File Credenza



- Four lateral file drawers
- Pre-installed filing hardware for letter or legal filing
- Side locking

WY_733	72" X 24" X 29"	Cubic Ft: 35.7	Ship Weight: 368	2669	2709	2749
---------------	-----------------	----------------	------------------	-------------	-------------	-------------

EXTRA THICK BOTTOM \$320 H

Freight Class: 125

TRADITIONAL LAMINATE



WY **M** CPR644
Finish

Zone Pricing	1	2	3
--------------	---	---	---

Lateral File Credenza



Left



Right

- Two lateral file drawers
- Pre-installed hardware for letter or legal filing

- Side locking
- Extra open storage pedestal on connecting side with two grommets

Freight Class: 125

WY_733L	72" X 24" X 29"	Cubic Ft: 35.7	Ship Weight: 254	1959	1988	2018
WY_733R	72" X 24" X 29"	Cubic Ft: 35.7	Ship Weight: 368	1959	1988	2018

EXTRA THICK BOTTOM \$160 H

Returns & Bridge

Desk Height Return

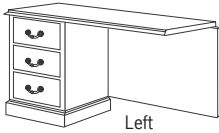

Left

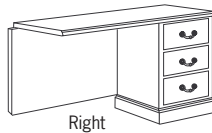

Right

- One box drawer
- One file drawer, letter or legal filing
- One grommet in modesty panel

- Locking pedestal
- Reverse coped edge for smooth connection
- Common grain direction with desk

Freight Class: 110

WY_722L	QS	48" X 24" X 29"	Cubic Ft: 24.3	Ship Weight: 152	1359	1379	1400	
					Keyboard Platform K	196	199	202
WY_722R	QS	48" X 24" X 29"	Cubic Ft: 24.3	Ship Weight: 152	1359	1379	1400	
					Keyboard Platform K	196	199	202
WY_622L		42" X 24" X 29"	Cubic Ft: 21.8	Ship Weight: 142	1334	1354	1374	
					Keyboard Platform K	196	199	202
WY_622R		42" X 24" X 29"	Cubic Ft: 21.8	Ship Weight: 142	1334	1354	1374	
					Keyboard Platform K	196	199	202

QS FINISHES **M**

Desk Height Bridge

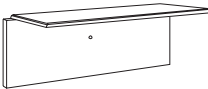

- One grommet in modesty panel
- Reverse coped edge on connecting sides
- Common grain direction with desk/credenza

Freight Class: 100

WY_485	QS	48" X 24" X 29"	Cubic Ft: 4	Ship Weight: 67	684	694	705
---------------	-----------	-----------------	-------------	-----------------	------------	------------	------------

QS FINISHES **M**

Files, Bookcase & Overhead Storage

Two Drawer File



- Two file drawers
- Pre-installed filing hardware for letter or legal filing
- Side locking pedestal

Freight Class: 100

WY_2DF	QS	17" X 24" X 29"	Cubic Ft: 10	Ship Weight: 111	1064	1080	1096
---------------	-----------	-----------------	--------------	------------------	-------------	-------------	-------------

QS FINISHES **M**

Standard Lateral File



- Two lateral file drawers
- Pre-installed filing hardware for letter or legal filing
- Side locking
- Anti-tilt mechanism inhibits more than one drawer from opening at a time

Freight Class: 100

WY_326		32" X 21.5" X 29"	Cubic Ft: 14	Ship Weight: 149	1263	1282	1301
---------------	--	-------------------	--------------	------------------	-------------	-------------	-------------

EXTRA THICK BOTTOM \$160 H

Zone Pricing	1	2	3
--------------	---	---	---

Executive Lateral File



- Two lateral file drawers
- Pre-installed filing hardware for letter or legal filing
- Side locking
- Anti-tilt mechanism inhibits more than one drawer from opening at a time

Freight Class: 100

WY_346 QS	38" X 24" X 29"	Cubic Ft: 19.5	Ship Weight: 198	1410	1431	1452
------------------	-----------------	----------------	------------------	-------------	-------------	-------------

QS FINISHES	M
--------------------	----------

EXTRA THICK BOTTOM	\$160 H
---------------------------	----------------

Three Drawer Lateral File



- Three lateral file drawers
- Pre-installed filing hardware for letter or legal filing
- Central locking
- Anti-tilt mechanism inhibits more than one drawer from opening at a time

Freight Class: 100

WY_336	32" X 21.5" X 44.5"	Cubic Ft: 27.9	Ship Weight: 215	2134	2166	2198
---------------	---------------------	----------------	------------------	-------------	-------------	-------------

EXTRA THICK BOTTOM	\$240 H
---------------------------	----------------

Four Drawer Lateral File



- Four lateral file drawers, letter and legal filing
- Central locking front
- Anti-tilt mechanism inhibits more than one drawer from opening at a time

Freight Class: 100

WY_426	32" X 21.5" X 56"	Cubic Ft: 27.9	Ship Weight: 252	2432	2468	2505
---------------	-------------------	----------------	------------------	-------------	-------------	-------------

EXTRA THICK BOTTOM	\$320 H
---------------------------	----------------

Overhead Storage Unit

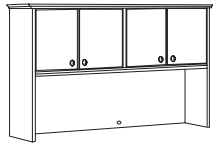

- WY_677 fits 66" credenzas
- WY_737 fits 72" credenzas
- Two storage compartments
- 21" clearance under compartments
- One wire management grommet in back panel
- Locks not available
- Optional tackboard available

Freight Class: 125

WY_677 QS	66" X 19" X 37"	Cubic Ft: 30.1	Ship Weight: 193	1638	1663	1687
------------------	-----------------	----------------	------------------	-------------	-------------	-------------

Task Light I	124	126	128
---------------------	-----	-----	-----

WY_737 QS	72" X 19" X 37"	Cubic Ft: 33.6	Ship Weight: 220	1865	1893	1921
------------------	-----------------	----------------	------------------	-------------	-------------	-------------

Task Light I	124	126	128
---------------------	-----	-----	-----

QS FINISHES	M
--------------------	----------

Open Overhead Storage

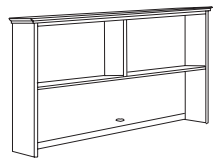

- WY_717 fits 72" credenzas
- WY_617 fits 66" credenzas
- Two storage compartments
- 21" clearance under compartments
- One wire management grommet in back panel
- Optional tackboard available

Freight Class: 125

WY_617	66" X 19" X 37"	Cubic Ft: 30.1	Ship Weight: 150	945	959	973
---------------	-----------------	----------------	------------------	------------	------------	------------

Task Light I	124	126	128
---------------------	-----	-----	-----

WY_717	72" X 19" X 37"	Cubic Ft: 33.6	Ship Weight: 210	1228	1246	1265
---------------	-----------------	----------------	------------------	-------------	-------------	-------------

Task Light I	124	126	128
---------------------	-----	-----	-----

Bookcase



- Three adjustable shelves
- Two fixed shelves (middle and bottom)
- 1" thick shelves
- Crown and base molding on three sides

Freight Class: 125

WY_65 QS	38" X 19" X 65"	Cubic Ft: 31.9	Ship Weight: 241	1031	1046	1062
-----------------	-----------------	----------------	------------------	-------------	-------------	-------------

QS FINISHES	M
--------------------	----------

TRADITIONAL LAMINATE

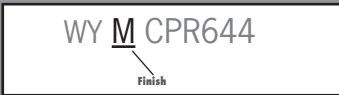

Reception Screens

Zone Pricing	1	2	3
--------------	---	---	---

Reception Screen for Main

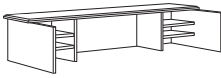

- Fits 66" x 30" single pedestal or double pedestal desks
- Matte finish
- Non-skid rubber strips on bottom prohibit movement
- Four adjustable shelves

Freight Class: 70

WY_610	QS	66" X 28" X 14"	Cubic Ft: 28.9	Ship Weight: 129	1081	1097	1113
---------------	-----------	-----------------	----------------	------------------	-------------	-------------	-------------

QS FINISHES	M
--------------------	----------

Reception Screen for Return

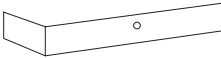

- Fits 48" x 24" executive height return
- Hardware included to join to main reception screen
- WY_611L fits left return
- WY_611R fits right return
- One wire management grommet
- Assembly required

Freight Class: 70

WY_611L	QS	48" X 22" X 13"	Cubic Ft: 1.5	Ship Weight: 25	256	260	264
----------------	-----------	-----------------	---------------	-----------------	------------	------------	------------

WY_611R	QS	48" X 22" X 13"	Cubic Ft: 1.5	Ship Weight: 25	256	260	264
----------------	-----------	-----------------	---------------	-----------------	------------	------------	------------

QS FINISHES	M
--------------------	----------

Center Drawers

Center Drawer

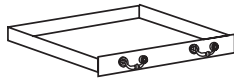

- WY_18 fits L-shaped and U-shaped workstations
- WY_19 fits 60" double pedestal desks
- WY_32 fits 66" double pedestal desks
- WY_38 fits 72" double pedestal desks

Freight Class: 100

WY_18	QS	25" X 18" X 3"	Cubic Ft: 1.5	Ship Weight: 11	149	151	153
--------------	-----------	----------------	---------------	-----------------	------------	------------	------------

WY_19	QS	26.75" X 18" X 3"	Cubic Ft: 2	Ship Weight: 12	149	151	153
--------------	-----------	-------------------	-------------	-----------------	------------	------------	------------

WY_32	QS	32.75" X 18" X 3"	Cubic Ft: 2.2	Ship Weight: 13	163	165	168
--------------	-----------	-------------------	---------------	-----------------	------------	------------	------------

WY_38	QS	38.75" X 18" X 3"	Cubic Ft: 2.2	Ship Weight: 13	163	165	168
--------------	-----------	-------------------	---------------	-----------------	------------	------------	------------

QS FINISHES	M
--------------------	----------

Technology

Drifter™ Table Top Power And Charging Hub

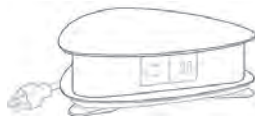

- 3 power outlets and 3 active USB ports
- 360° Access
- Built-in cord management
- 108" cord length
- Kit included to secure to worksurface when mobility is not desired
- DW - Gloss White
- DS - Silver Pearl
- DB - Black

Freight Class: 125

DW	10"W X 10"D X 2.85"H	Cubic Ft: 1	Ship Weight: 6	895	908	922
-----------	----------------------	-------------	----------------	------------	------------	------------

DS	10"W X 10"D X 2.85"H	Cubic Ft: 1	Ship Weight: 6	895	908	922
-----------	----------------------	-------------	----------------	------------	------------	------------

DB	10"W X 10"D X 2.85"H	Cubic Ft: 1	Ship Weight: 6	895	908	922
-----------	----------------------	-------------	----------------	------------	------------	------------

Tripod Portable Power Base



- 9 power outlets
- 6 active USB ports
- 108" cord with molded plug
- ECIB_108 - Black
- ECIS_108 - Silver Pearl
- ECIW_108 - Gloss White

Freight Class: 125

ECIB_108	18"W X 18"D X 25.5"H	Cubic Ft: 6	Ship Weight: 39	2498	2535	2573
-----------------	----------------------	-------------	-----------------	-------------	-------------	-------------

ECIS_108	18"W X 18"D X 25.5"H	Cubic Ft: 6	Ship Weight: 39	2498	2535	2573
-----------------	----------------------	-------------	-----------------	-------------	-------------	-------------

ECIW_108	18"W X 18"D X 25.5"H	Cubic Ft: 6	Ship Weight: 39	2498	2535	2573
-----------------	----------------------	-------------	-----------------	-------------	-------------	-------------

TRADITIONAL LAMINATE

Zone Pricing	1	2	3
--------------	---	---	---

CPU Storage Unit



- Mounts under workstation
- Capable of housing tower or desk top styles CPU
- Unit slides in/out and rotates for easy access

Freight Class: 100

MDCPU	QS	Cubic Ft: 1	Ship Weight: 20	294	298	303
-------	----	-------------	-----------------	-----	-----	-----

Power Strips

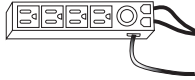

- Moulded of high impact, flame resistant plastic
- Four electrical outlets
- Two data lines
- UL and CSA certified
- Surge protection
- RJ 11 jack- hook up for phone, modem or fax
- Ratings: 120 volt, 60 Hz, 13 amp

Freight Class: 75

MDE	QS	Cubic Ft: 1	Ship Weight: 2	152	154	157
-----	----	-------------	----------------	-----	-----	-----

Wire Management Channel

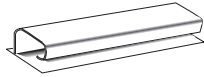

- Attaches under tops or to modesty panels for wire concealment and management
- Peel and stick self adhesive
- Front end opening for easy access

Freight Class: 100

MDWM	QS	12" x 2.25" x 1.25"	Cubic Ft: .04	Ship Weight: 1	30	30	31
------	----	---------------------	---------------	----------------	----	----	----

Task Light

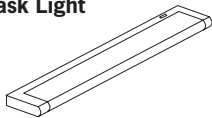

- Black with white lens and warm white light
- Convenient on/off switch
- 720 Lumen, 8 watt, 120 V
- 10 ft. powercord
- UL labeled

Freight Class: 200

TL2P	QS	21" x 1.25" x 1"	Cubic Ft: 1	Ship Weight: 3	124	126	128
------	----	------------------	-------------	----------------	-----	-----	-----

Factory-installation available: add **I** to end of overhead model number and prices above to list price of unit.

Keyboard Trays & Center Drawers

Pullout Keyboard Platform

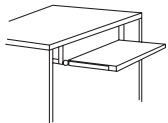

- HW_K21 fits 60" double pedestal desks, 66" or 72" single pedestal desks, computer corner desks, 48" and 42" returns, extended corner returns and 30" and 36" shells
- HW_K25 or HW_K29 fits 66" or 72" double pedestal desks, computer credenzas, bridges and 42" and larger shells
- Available as Quick Ship in all Hyperwork finishes

Freight Class: 100

HW_K25	QS	25" x 18" x	Cubic Ft: 2	Ship Weight: 13	196	199	202
--------	----	-------------	-------------	-----------------	-----	-----	-----

HW_K21	QS	21" x 18" x	Cubic Ft: 2	Ship Weight: 12	196	199	202
--------	----	-------------	-------------	-----------------	-----	-----	-----

HW_K29	QS	29" x 18" x	Cubic Ft: 2	Ship Weight: 17	203	206	209
--------	----	-------------	-------------	-----------------	-----	-----	-----

Use with Atlas and Hyperwork

Center Drawer

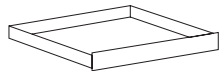

- HW_CD19 fits 66" single pedestal desks
- HW_CD25 fits 60" double pedestal desks, 72" and 48" single pedestal desks
- HW_CD32 fits 66" double pedestal desks
- HW_CD38 fits 72" double pedestal desks
- Available as Quick Ship in all Hyperwork finishes

Freight Class: 100

HW_CD19	QS	19.5" x 18" x 3"	Cubic Ft: 1.5	Ship Weight: 11	165	167	170
---------	----	------------------	---------------	-----------------	-----	-----	-----

HW_CD25	QS	25.5" x 18" x 3"	Cubic Ft: 1.5	Ship Weight: 12	165	167	170
---------	----	------------------	---------------	-----------------	-----	-----	-----

HW_CD32	QS	32" x 18" x 3"	Cubic Ft: 2.2	Ship Weight: 13	177	180	182
---------	----	----------------	---------------	-----------------	-----	-----	-----

HW_CD38	QS	38" x 18" x 3"	Cubic Ft: 2.2	Ship Weight: 13	177	180	182
---------	----	----------------	---------------	-----------------	-----	-----	-----

Use with Atlas and Hyperwork

Pullout Keyboard Platform

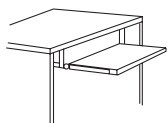

- Platform only; does not include table
- PKP35 requires a 26" kneespace and fits single pedestal units for L-shaped and U-shaped workstations
- PKMP36 requires 33" kneespace and fits 66" or 72" double pedestal desks, credenzas or bridges
- PKP25 fits 66" or 72" double pedestal desks, credenzas or bridges
- Available as Quick Ship in Mahogany (MAH), Natural Maple (FM) and Windsor Cherry (WC)

Freight Class: 100

PKP35_	QS	22" x 18" x	Cubic Ft: 2	Ship Weight: 12	196	199	202
--------	----	-------------	-------------	-----------------	-----	-----	-----

PKP25_	QS	25" x 18" x	Cubic Ft: 2	Ship Weight: 15	199	202	205
--------	----	-------------	-------------	-----------------	-----	-----	-----

PKMP36_	QS	29" x 18" x	Cubic Ft: 2	Ship Weight: 17	203	206	209
---------	----	-------------	-------------	-----------------	-----	-----	-----

Use with Vitality and Wyndham

Zone Pricing	1	2	3
--------------	---	---	---

Articulating Keyboard Supports

Curved Platform 20.5" Free-Float

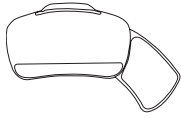

- Black finish
- Left/right-hand sliding mousepad
- Gel wristrest
- Cord managers
- Usable surface 18.5" W x 8" D
- Free-float mechanism
- Can be shipped via FedEx Ground

Freight Class: 70

AKT008/06720.5 QS	21-29" x 13" x 22-32" Cubic Ft: 1.3 Ship Weight: 17	683	693	703
--------------------------	---	------------	------------	------------

Curved Platform 23" Free-Float

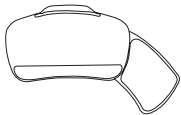

- Black finish
- Left/right-hand sliding mousepad
- Gel wristrest
- Cord managers
- Usable surface 18.5" W x 8" D
- Free-float mechanism
- Can be shipped via FedEx Ground

Freight Class: 70

AKT008/06623 QS	21-29" x 13" x 22-32" Cubic Ft: 1.3 Ship Weight: 18	742	753	764
------------------------	---	------------	------------	------------

Rectangular Platform 17" Spring Assist



- Black finish
- Left/right-hand sliding mousepad
- Gel wristrest
- Cord managers
- Usable surface 21.25" W x 8.25" D
- Spring-assist mechanism
- Can be shipped via FedEx Ground

Freight Class: 70

AKT007/02517 QS	22-31" x 12" x 22-32" Cubic Ft: 1.3 Ship Weight: 17	472	479	486
------------------------	---	------------	------------	------------

Rectangular Platform 20.5" Free-Float



- Black finish
- Left/right-hand sliding mousepad
- Gel wristrest
- Cord managers
- Usable surface 21.25" W x 8.25" D
- Free-float mechanism
- Can be shipped via FedEx Ground

Freight Class: 70

AKT007/06720.5 QS	22-31" x 12" x 22-32" Cubic Ft: 1.3 Ship Weight: 18	532	540	548
--------------------------	---	------------	------------	------------

Rectangular Platform 23" Free-Float



- Black finish
- Left/right-hand sliding mousepad
- Gel wristrest
- Cord managers
- Usable surface 21.25" W x 8.25" D
- Free-float mechanism /23" track & 7.5 neck
- Can be shipped via FedEx Ground

Freight Class: 70

AKT007/06623 QS	22-31" x 12" x 22-32" Cubic Ft: 1.3 Ship Weight: 20	594	603	612
------------------------	---	------------	------------	------------

Benching/Privacy Panels, Tack & White Boards

Zone
Pricing

1

2

3

Benching/Privacy Panels for Desktop



- 14" high benching/privacy panels for desktops in multi-station configurations
- Join with other panels to form "L" or "U" shapes, panels are not stand alone
- Joint Kit sold separate. order one kit per joint
- Available in all Hyperwork finishes

Part #	Dimensions	Cubic Ft.	Ship Weight	1	2	3
HS__24	24" X .75" X 14"	2	10	131	133	135
HS__30	30" X .75" X 14"	2	11	144	146	148
HS__36	36" X .75" X 14"	2	12	154	156	159
HS__42	42" X .75" X 14"	2	14	165	167	170
HS__48	48" X .75" X 14"	2	15	176	179	181
HS__54	54" X .75" X 14"	3	17	207	210	213
HS__60	60" X .75" X 14"	3	19	231	234	238
HS__66	66" X .75" X 14"	3	21	246	250	253
HS__72	72" X .75" X 14"	3	23	270	274	278
HS__78	78" X .75" X 14"	3	24	285	289	294

Use with Atlas and Hyperwork Laminate Series

Freight Class: 100

Joint Kit

- Connects benching/privacy panels to form "L" or "U" shapes
- Kit includes two hinges and one wrench
- Hinges feature brushed nickel finish
- One kit required per connection

Part #	Cubic Ft.	Ship Weight	1	2	3
HSJK	0.3	1	203	206	209

Freight Class: 100

Tack Board for Privacy Panel



- Fabric covered fully tackable surface
- Pricing is for Grade 1 fabrics
- Contact your HPFI representative for other fabric grades
- Field installation required
- Tack boards fit privacy panels with corresponding numbers
- Quick Ship if ordered in QS fabric

Part #	Dimensions	Cubic Ft.	Ship Weight	1	2	3
HSTB24 QS	19.25" X 12"	1.4	3	190	193	196
HSTB30 QS	25.25" X 12"	1.4	3.25	193	196	199
HSTB36 QS	31.25" X 12"	1.4	3.5	195	198	201
HSTB42 QS	37.25" X 12"	1.4	3.75	214	217	220
HSTB48 QS	43.25" X 12"	1.4	4	216	219	222
HSTB54 QS	49.25" X 12"	1.4	4.25	227	230	234
HSTB60 QS	55.25" X 12"	1.4	4.5	229	232	236
HSTB66 QS	61.25" X 12"	1.4	4.75	232	235	239
HSTB72 QS	67.25" X 12"	1.4	5	234	238	241
HSTB78 QS	73.25" X 12"	1.4	5	236	240	243

Freight Class: 100

White Dry-Erase Board

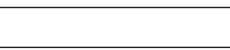

- Use with erasable markers and dry eraser
- Field installation required
- White dry-erase boards fit privacy panels with corresponding numbers

Part #	Dimensions	Cubic Ft.	Ship Weight	1	2	3
HSWB24	19.25" X 12"	1.5	4	292	296	301
HSWB30	25.25" X 12"	1.5	4.5	336	341	346
HSWB36	31.25" X 12"	1.5	5	351	356	362
HSWB42	37.25" X 12"	1.5	6	416	422	428
HSWB48	43.25" X 12"	1.5	7	416	422	428
HSWB54	49.25" X 12"	1.5	8	471	478	485
HSWB60	55.25" X 12"	2.5	8	502	510	517
HSWB66	61.25" X 12"	2.5	10	513	521	528
HSWB72	67.25" X 12"	2.5	11	520	528	536
HSWB78	73.25" X 12"	2.5	12	531	539	547

Freight Class: 100

Zone Pricing	1	2	3
--------------	---	---	---

Accessory Wall



- Three channels for accessory attachment
- Accessories clip and lock into position
- Black color
- Field installation required
- Accessory walls fit privacy panels with corresponding numbers

HSAW24	19.25" X 0.5" X 7"	Cubic Ft: 1.4	Ship Weight: 3	76	77	78
HSAW30	25.25" X 0.5" X 7"	Cubic Ft: 1.4	Ship Weight: 3.25	79	80	81
HSAW36	31.25" X 0.5" X 7"	Cubic Ft: 1.4	Ship Weight: 3.5	90	91	93
HSAW42	37.25" X 0.5" X 7"	Cubic Ft: 1.4	Ship Weight: 3.75	91	92	94
HSAW48	43.25" X 0.5" X 7"	Cubic Ft: 1.4	Ship Weight: 4	99	100	102
HSAW54	49.25" X 0.5" X 7"	Cubic Ft: 1.4	Ship Weight: 4.25	112	114	115
HSAW60	55.25" X 0.5" X 7"	Cubic Ft: 1.4	Ship Weight: 4.5	120	122	124
HSAW66	61.25" X 0.5" X 7"	Cubic Ft: 1.4	Ship Weight: 4.75	127	129	131
HSAW72	67.25" X 0.5" X 7"	Cubic Ft: 1.4	Ship Weight: 5	128	130	132
HSAW78	72" X 0.5" X 7"	Cubic Ft: 1.4	Ship Weight: 5.25	156	158	161

Freight Class: 100

Tack Board 14" High For 72" Overhead HWTB1472 68.75" X 0.5" X 14"



- Fully tackable surface
- Choose any fabric
- Quick Ship in QS fabrics
- Not installed (shipped separate)
- Use with Vitality, Atlas and Hyperwork

Grade	1	2	3	4	5	6	7	8	9	10
Zone 1	247	273	306	342	372	412	451	492	530	581
Zone 2	251	277	311	347	378	418	458	499	538	590
Zone 3	254	281	315	352	383	424	465	507	546	598

68.75" X 0.5" X 14"

Freight Class: 100

Cubic Ft: 2.6

Ship Weight: 6

Tack Board 14" High For 66" Overhead HWTB1466 63.25" X 0.5" X 14"



- Fully tackable surface
- Choose any fabric
- Quick Ship in QS fabrics
- Not installed (shipped separate)
- Use with Vitality, Atlas, Hyperwork

Grade	1	2	3	4	5	6	7	8	9	10
Zone 1	247	273	306	342	372	412	451	492	530	581
Zone 2	251	277	311	347	378	418	458	499	538	590
Zone 3	254	281	315	352	383	424	465	507	546	598

63.25" X 0.5" X 14"

Freight Class: 100

Cubic Ft: 2.6

Ship Weight: 6

Tack Board 14" High For 60" Overhead HWTB1460 57.25" X 0.5" X 14"



- Fully tackable surface
- Choose any fabric
- Quick Ship in QS fabrics
- Not installed (shipped separate)
- Use with Vitality, Atlas and Hyperwork

Grade	1	2	3	4	5	6	7	8	9	10
Zone 1	247	273	306	342	372	412	451	492	530	581
Zone 2	251	277	311	347	378	418	458	499	538	590
Zone 3	254	281	315	352	383	424	465	507	546	598

57.25" X 0.5" X 14"

Freight Class: 100

Cubic Ft: 2.6

Ship Weight: 6

Tack Board 14" High For 54" Overhead HWTB1454 51.25" X 0.5" X 14"



- Fully tackable surface
- Choose any fabric
- Quick Ship in QS fabrics
- Not installed (shipped separate)
- Use with Vitality, Atlas and Hyperwork

Grade	1	2	3	4	5	6	7	8	9	10
Zone 1	247	273	306	342	372	412	451	492	530	581
Zone 2	251	277	311	347	378	418	458	499	538	590
Zone 3	254	281	315	352	383	424	465	507	546	598

51.25" X 0.5" X 14"

Freight Class: 100

Cubic Ft: 2.6

Ship Weight: 6

Tack Board 14" High For 48" Overhead HWTB1448 45.25" X 0.5" X 14"



- Fully tackable surface
- Choose any fabric
- Quick Ship in QS fabrics
- Not installed (shipped separate)
- Use with Vitality, Atlas and Hyperwork

Grade	1	2	3	4	5	6	7	8	9	10
Zone 1	220	242	275	301	328	360	394	428	463	504
Zone 2	223	246	279	306	333	365	400	434	470	512
Zone 3	227	249	283	310	338	371	406	441	477	519

45.25" X 0.5" X 14"
Freight Class: 100

Cubic Ft: 2.6
Ship Weight: 6

Tack Board 14" High For 42" Overhead HWTB1442 39.25" X 0.5" X 14"



- Fully tackable surface
- Choose any fabric
- Quick Ship in QS fabrics
- Not installed (shipped separate)
- Use with Vitality, Atlas and Hyperwork

Grade	1	2	3	4	5	6	7	8	9	10
Zone 1	220	242	275	301	328	360	394	428	463	504
Zone 2	223	246	279	306	333	365	400	434	470	512
Zone 3	227	249	283	310	338	371	406	441	477	519

39.25" X 0.5" X 14"
Freight Class: 100

Cubic Ft: 2.6
Ship Weight: 6

Tack Board 14" High For 36" Overhead HWTB1436 33.25" X 0.5" X 14"



- Fully tackable surface
- Choose any fabric
- Quick Ship in QS fabrics
- Not installed (shipped separate)
- Use with Vitality, Atlas and Hyperwork

Grade	1	2	3	4	5	6	7	8	9	10
Zone 1	220	242	275	301	328	360	394	428	463	504
Zone 2	223	246	279	306	333	365	400	434	470	512
Zone 3	227	249	283	310	338	371	406	441	477	519

33.25" X 0.5" X 14"
Freight Class: 100

Cubic Ft: 2.6
Ship Weight: 6

Tack Board 14" High For 30" Overhead HWTB1430 27.25" X 0.5" X 14"



- Fully tackable surface
- Choose any fabric
- Quick Ship in QS fabrics
- Not installed (shipped separate)
- Use with Vitality, Atlas and Hyperwork

Grade	1	2	3	4	5	6	7	8	9	10
Zone 1	220	242	275	301	328	360	394	428	463	504
Zone 2	223	246	279	306	333	365	400	434	470	512
Zone 3	227	249	283	310	338	371	406	441	477	519

27.25" X 0.5" X 14"
Freight Class: 100

Cubic Ft: 2.6
Ship Weight: 6

Tack Board 14" High For Corner Hutch Return HWTB1424 21.25" X 0.5" X 14"



- Fabric covered tack boards
- Choose any fabric
- Quick Ship in QS fabrics
- Not installed (shipped separate)
- Fits Hyperwork corner hutch returns

Grade	1	2	3	4	5	6	7	8	9	10
Zone 1	220	242	275	301	328	360	394	428	463	504
Zone 2	223	246	279	306	333	365	400	434	470	512
Zone 3	227	249	283	310	338	371	406	441	477	519

21.25" X 0.5" X 14"
Freight Class: 100

Cubic Ft: 2.6
Ship Weight: 6

Tack Board 7" High For 72" Overhead HWTB772 69.25" X 0.5" X 7"

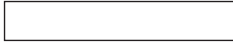

- Fully tackable surface
- Choose any fabric
- Quick Ship in QS fabrics
- Not installed (shipped separate)
- Use with Vitality, Atlas and Hyperwork

69.25" X 0.5" X 7"
Freight Class: 100

Grade	1	2	3	4	5	6	7	8	9	10
Zone 1	220	242	275	301	328	360	394	428	463	504
Zone 2	223	246	279	306	333	365	400	434	470	512
Zone 3	227	249	283	310	338	371	406	441	477	519

Cubic Ft: 1.25
Ship Weight: 3

Tack Board 7" High For 66" Overhead HWTB766 63.25" X 0.5" X 7"



- Fully tackable surface
- Choose any fabric
- Quick Ship in QS fabrics
- Not installed (shipped separate)
- Use with Vitality, Atlas and Hyperwork

63.25" X 0.5" X 7"
Freight Class: 100

Grade	1	2	3	4	5	6	7	8	9	10
Zone 1	220	242	275	301	328	360	394	428	463	504
Zone 2	223	246	279	306	333	365	400	434	470	512
Zone 3	227	249	283	310	338	371	406	441	477	519

Cubic Ft: 1.25
Ship Weight: 3

Tack Board 7" High For 60" Overhead HWTB760 57.25" X 0.5" X 7"



- Fully tackable surface
- Choose any fabric
- Quick Ship in QS fabrics
- Not installed (shipped separate)
- Use with Vitality, Atlas and Hyperwork

57.25" X 0.5" X 7"
Freight Class: 100

Grade	1	2	3	4	5	6	7	8	9	10
Zone 1	220	242	275	301	328	360	394	428	463	504
Zone 2	223	246	279	306	333	365	400	434	470	512
Zone 3	227	249	283	310	338	371	406	441	477	519

Cubic Ft: 1.25
Ship Weight: 3

Tack Board 64" or 66" Overheads TBBP62 61.25" X 0.5" X 12.75"



- Fully tackable surface
- Choose any fabric
- Quick Ship in QS fabrics
- Not installed (shipped separate)
- Use with TR_3077 and WY_677

61.25" X 0.5" X 12.75"
Freight Class: 100

Grade	1	2	3	4	5	6	7	8	9	10
Zone 1	220	242	275	301	328	360	394	428	463	504
Zone 2	223	246	279	306	333	365	400	434	470	512
Zone 3	227	249	283	310	338	371	406	441	477	519

Cubic Ft: 2
Ship Weight: 6

Tack Board for 70" Overheads TBBP70 67.25" X 0.5" X 12.75"



- Fully tackable surface
- Choose any fabric
- Quick Ship in QS fabrics
- Not installed (shipped separate)
- Use with WY_717 and WY_737

67.25" X 0.5" X 12.75"
Freight Class: 100

Grade	1	2	3	4	5	6	7	8	9	10
Zone 1	220	242	275	301	328	360	394	428	463	504
Zone 2	223	246	279	306	333	365	400	434	470	512
Zone 3	227	249	283	310	338	371	406	441	477	519

Cubic Ft: 2.5
Ship Weight: 6

Tack Board for Bedford 72" Overheads TBBF70 67.5" X 0.5" X 14"



- Fully tackable surface
- Choose any fabric
- Quick Ship in QS fabrics
- Not installed (shipped separate)
- Use with Bedford TR_3071 overhead storage

67.5" X 0.5" X 14"
Freight Class: 100

Grade	1	2	3	4	5	6	7	8	9	10
Zone 1	220	242	275	301	328	360	394	428	463	504
Zone 2	223	246	279	306	333	365	400	434	470	512
Zone 3	227	249	283	310	338	371	406	441	477	519

Cubic Ft: 3
Ship Weight: 7

Accessory Wall

Accessory Wall 14" High



- Six channels for accessory attachment
- Black color
- Field installed
- AW1472 fits 72" Overhead
- AW1466 fits 66" Overhead
- AW1460 fits 60" Overhead

AW1472	69.25" X 0.5" X 14"	Cubic Ft: 2.6	Ship Weight: 15	221	224	228
AW1466	63.25" X 0.5" X 14"	Cubic Ft: 2.6	Ship Weight: 15	221	224	228
AW1460	57.25" X 0.5" X 14"	Cubic Ft: 2.6	Ship Weight: 15	221	224	228

Freight Class: 100

Accessory Wall 7" High



- Three channels for accessory attachment
- Black color
- Field installed
- AW772 fits 72" Overhead
- AW766 fits 66" Overhead
- AW760 fits 60" Overhead

AW772	69.25" X 0.5" X 7"	Cubic Ft: 1.3	Ship Weight: 10	112	114	115
AW766	63.25" X 0.5" X 7"	Cubic Ft: 1.3	Ship Weight: 10	112	114	115
AW760	57.25" X 0.5" X 7"	Cubic Ft: 1.3	Ship Weight: 10	112	114	115

Freight Class: 100

Personal Organization

Zone Pricing

1

2

3

Pen Holder



- Stores up to 24 pencils
- 4 lb. capacity
- 4" X 3.5" X 4"

MD1000	QS	4" X 3.5" X 4"		17	17	18
---------------	-----------	----------------	--	-----------	-----------	-----------

Freight Class: 100

CD Holder



- Stores 10 CDs within easy reach
- 4 lb. capacity
- 7" X 5.5" X 2"

MD1001	QS	7" X 5.5" X 2"		27	27	28
---------------	-----------	----------------	--	-----------	-----------	-----------

Freight Class: 100

File Holder

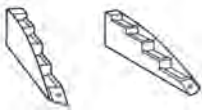

- Stores files horizontally
- 10 lb. capacity
- 1" X 8.5" X 2"

MD1002	QS	1" X 8.5" X 2"		17	17	18
---------------	-----------	----------------	--	-----------	-----------	-----------

Freight Class: 100

Paper Tray Letter Size



- Stores letter size sheets
- 5 lb. capacity
- 9.5" X 14" X 2"

MD1003	QS	9.5" X 14" X 2"		51	52	53
---------------	-----------	-----------------	--	-----------	-----------	-----------

Freight Class: 100

Accessory Tray



- Stores notepads, Post-its, pens etc.
- 5 lb. capacity
- 10" X 9.5" X 2"

Freight Class: 100

Phone Base



- 5 lb. capacity
- 8.5" X 9.5" X 2"

Freight Class: 100

Paper Tray Legal Size



- Stores legal size sheets
- 7 lb. capacity
- 15" X 10.5" X 2"

Freight Class: 100

Folder Tray



- Stores files vertically
- 10 lb. capacity
- 7" X 12.5" X 8"

Freight Class: 100

Binder Holder



- Stores binders, phone books, etc.
- 10 lb. capacity
- 5" X 9" X 10.5"
- Requires 14" high accessory wall

Freight Class: 100

Cup Holder



- Holds cans, coffee cups, etc.
- 4 lb. capacity
- 4" X 5" X 2"

Freight Class: 100

Shelves



- 18" Shelf - 15 lb. capacity
- 24" Shelf - 15 lb. capacity
- 30" Shelf - 18 lb. capacity
- 36" Shelf - 25 lb. capacity

Freight Class: 100

Zone Pricing	1	2	3
--------------	---	---	---

MD1004 QS	10" X 9.5" X 2"	34	35	35
------------------	-----------------	-----------	-----------	-----------

MD1005 QS	8.5" X 9.5" X 2"	41	42	42
------------------	------------------	-----------	-----------	-----------

MD1007 QS	15" X 10.5" X 2"	51	52	53
------------------	------------------	-----------	-----------	-----------

MD1008 QS	7" X 12.5" X 8"	59	60	61
------------------	-----------------	-----------	-----------	-----------

MD1009 QS	5" X 9" X 10.5"	27	27	28
------------------	-----------------	-----------	-----------	-----------

MD1014 QS	4" X 5" X 2"	17	17	18
------------------	--------------	-----------	-----------	-----------

MDSHELF18 QS	18" X 7" X 2"	100	102	103
MDSHELF24 QS	24" X 7" X 2"	125	127	129
MDSHELF30 QS	30" X 7" X 2"	142	144	146
MDSHELF36 QS	36" X 7" X 2"	165	167	170

TABLES





MATRIX tables are the answer to the need for "touchdown spaces" to read and respond to emails, texts, social media or voice mail. Matrix provides meeting space for teams to gather and collaborate on projects.

For installed power, see PowerFlex accessories.

Specifications subject to change without notice.

- Tops are rectangular or tapered in 6' or 8' lengths
- 36" counter height or 42" standing height
- Rectangular tops are 24" or 30" deep
- Tapered tops are 24/36" or 30/42" deep
- Bases available in all laminate or laminate with perforated steel inserts
- Cutouts under top and open base design allows channeling power to the floor



Rectangular Top, All-Laminate Bases, Counter Height

Zone Pricing	1	2	3
--------------	---	---	---

Rectangular Table, All-Laminate Bases

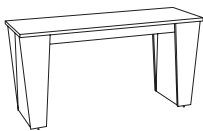

- 6' rectangular top
- All laminate bases
- 36" counter height
- Ships in three cartons
- Simple assembly required

Freight Class: 100

M_RC624	72" X 24" X 36"	Cubic Ft: 18	Ship Weight: 234	1694	1719	1745
----------------	-----------------	--------------	------------------	-------------	-------------	-------------

Rectangular Table, All-Laminate Bases



- 8' rectangular top
- All laminate bases
- 36" counter height
- Ships in three cartons
- Simple assembly required

Freight Class: 100

M_RC824	96" X 24" X 36"	Cubic Ft: 20	Ship Weight: 246	1970	2000	2029
----------------	-----------------	--------------	------------------	-------------	-------------	-------------

Rectangular Table, All-Laminate Bases

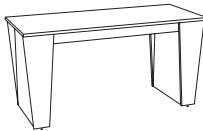

- 6' rectangular top
- All laminate bases
- 36" counter height
- Ships in three cartons
- Simple assembly required

Freight Class: 125

M_RC630	72" X 30" X 36"	Cubic Ft: 22.5	Ship Weight: 252	1835	1863	1890
----------------	-----------------	----------------	------------------	-------------	-------------	-------------

Rectangular Table, All-Laminate Bases



- 8' rectangular top
- All laminate bases
- 36" counter height
- Ships in three cartons
- Simple assembly required

Freight Class: 125

M_RC830	96" X 30" X 36"	Cubic Ft: 25	Ship Weight: 264	2109	2141	2172
----------------	-----------------	--------------	------------------	-------------	-------------	-------------

Rectangular Top, All-Laminate Bases, Standing Height

Rectangular Table, All-Laminate Bases

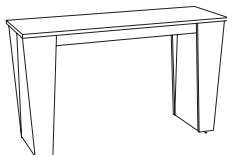







- 6' rectangular top
- All laminate bases
- 42" standing height
- Ships in three cartons
- Simple assembly required

Freight Class: 100

M_RB624	72" X 24" X 42"	Cubic Ft: 20	Ship Weight: 264	1798	1825	1852
----------------	-----------------	--------------	------------------	-------------	-------------	-------------

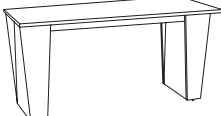
FINISH SELECTION

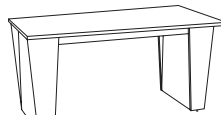
BLACK **E** | BOARDWALK **BW** | DRIFTWOOD **DW** | ESPRESSO **X** |
 GRAPHITE **GP** | MAHOGANY **M** | NATURAL MAPLE **FM** | SHORELINE **SL** |
 WINDSOR CHERRY **WC** |

		Zone Pricing		1	2	3			
Rectangular Table, All-Laminate Bases  <ul style="list-style-type: none"> • 8' rectangular top • All laminate bases • 42" standing height • Ships in three cartons • Simple assembly required 		M_RB824	96" X 24" X 42"	Cubic Ft: 22	Ship Weight: 278	2073	2104	2135	
Freight Class: 100									
Rectangular Table, All-Laminate Bases  <ul style="list-style-type: none"> • 6' rectangular top • All laminate bases • 42" standing height • Ships in three cartons • Simple assembly required 		M_RB630	72" X 30" X 42"	Cubic Ft: 24.5	Ship Weight: 272	2176	2209	2241	
Freight Class: 125									
Rectangular Table, All-Laminate Bases  <ul style="list-style-type: none"> • 8' rectangular top • All laminate bases • 42" standing height • Ships in three cartons • Simple assembly required 		M_RB830	96" X 30" X 42"	Cubic Ft: 27	Ship Weight: 284	2213	2246	2279	
Freight Class: 125									
Tapered Top, All-Laminate Bases, Counter Height									
Tapered Top Table, All-Laminate Bases  <ul style="list-style-type: none"> • 6' tapered top • All laminate bases • 36" counter height • Ships in three cartons • Simple assembly required 		M_TC636	72" X 36/24" X 36"	Cubic Ft: 21	Ship Weight: 252	1904	1933	1961	
Freight Class: 100									
Tapered Top Table, All-Laminate Bases  <ul style="list-style-type: none"> • 8' tapered top • All laminate bases • 36" counter height • Ships in three cartons • Simple assembly required 		M_TC836	96" X 36/24" X 36"	Cubic Ft: 24	Ship Weight: 264	2124	2156	2188	
Freight Class: 125									
Tapered Top Table, All-Laminate Bases  <ul style="list-style-type: none"> • 6' tapered top • All laminate bases • 36" counter height • Ships in three cartons • Simple assembly required 		M_TC642	72" X 42/30" X 36"	Cubic Ft: 24	Ship Weight: 258	2047	2078	2108	
Freight Class: 125									
Tapered Top Table, All-Laminate Bases  <ul style="list-style-type: none"> • 8' tapered top • All laminate bases • 36" counter height • Ships in three cartons • Simple assembly required 		M_TC842	96" X 42/30" X 36"	Cubic Ft: 29	Ship Weight: 270	2290	2324	2359	
Freight Class: 125									

MEETING TABLES



Tapered Top, All-Laminate Bases, Standing Height

Zone Pricing	1	2	3
--------------	---	---	---

Tapered Top Table, All-Laminate Bases

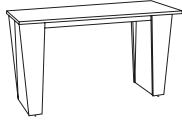

- 6' tapered top
- All laminate bases
- 42" standing height
- Ships in three cartons
- Simple assembly required

M_TB636	72" X 36/24" X 42"	Cubic Ft: 23	Ship Weight: 270	2008	2038	2068
----------------	--------------------	--------------	------------------	-------------	-------------	-------------

Freight Class: 100

Tapered Top Table, All-Laminate Bases

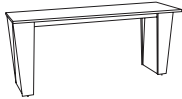

- 8' tapered top
- All laminate bases
- 42" standing height
- Ships in three cartons
- Simple assembly required

M_TB836	96" X 36/24" X 42"	Cubic Ft: 26	Ship Weight: 282	2227	2260	2294
----------------	--------------------	--------------	------------------	-------------	-------------	-------------

Freight Class: 125

Tapered Top Table, All-Laminate Bases

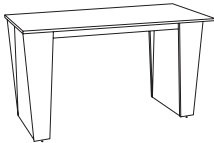

- 6' tapered top
- All laminate bases
- 42" standing height
- Ships in three cartons
- Simple assembly required

M_TB642	72" X 42/30" X 42"	Cubic Ft: 27.5	Ship Weight: 278	2151	2183	2216
----------------	--------------------	----------------	------------------	-------------	-------------	-------------

Freight Class: 125

Tapered Top Table, All-Laminate Bases

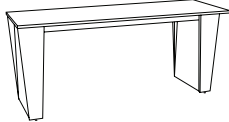

- 8' tapered top
- All laminate bases
- 42" standing height
- Ships in three cartons
- Simple assembly required

M_TB842	96" X 42/30" X 42"	Cubic Ft: 31	Ship Weight: 290	2394	2430	2466
----------------	--------------------	--------------	------------------	-------------	-------------	-------------

Freight Class: 125

Rectangular Top, Perforated Steel Insert Bases, Counter Height

Rectangular Table, Laminate Bases w/Perforated Steel Inserts

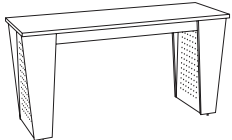

- 6' rectangular top
- Laminate bases with perforated steel inserts
- 36" counter height
- Ships in three cartons
- Simple assembly required

M_RC624P	72" X 24" X 36"	Cubic Ft: 18	Ship Weight: 234	2434	2471	2507
-----------------	-----------------	--------------	------------------	-------------	-------------	-------------

Freight Class: 100

Rectangular Table, Laminate Bases w/Perforated Steel Inserts

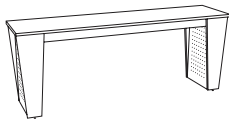

- 8' rectangular top
- Laminate bases with perforated steel inserts
- 36" counter height
- Ships in three cartons
- Simple assembly required

M_RC824P	96" X 24" X 36"	Cubic Ft: 20	Ship Weight: 246	2710	2751	2791
-----------------	-----------------	--------------	------------------	-------------	-------------	-------------

Freight Class: 100

Rectangular Table, Laminate Bases w/Perforated Steel Inserts

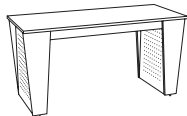

- 6' rectangular top
- Laminate bases with perforated steel inserts
- 36" counter height
- Ships in three cartons
- Simple assembly required

M_RC630P	72" X 30" X 36"	Cubic Ft: 22.5	Ship Weight: 252	2649	2689	2728
-----------------	-----------------	----------------	------------------	-------------	-------------	-------------

Freight Class: 125

FINISH SELECTION

BLACK **E** | BOARDWALK **BW** | DRIFTWOOD **DW** | ESPRESSO **X** |
 GRAPHITE **GP** | MAHOGANY **M** | NATURAL MAPLE **FM** | SHORELINE **SL** |
 WINDSOR CHERRY **WC** |

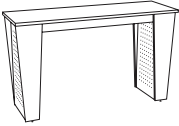
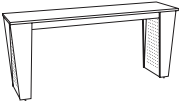
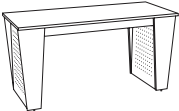
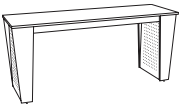
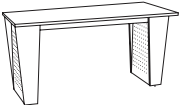
		Zone Pricing	1	2	3	
Rectangular Table, Laminate Bases w/Perforated Steel Inserts  <ul style="list-style-type: none"> • 8' rectangular top • Laminate bases with perforated steel inserts • 36" counter height • Ships in three cartons • Simple assembly required Freight Class: 100		M_RC830P	96" X 30" X 36" Cubic Ft: 25 Ship Weight: 264	2924	2968	3012
Rectangular Top, Perforated Steel Insert Bases, Standing Height						
Rectangular Table, Laminated Bases w/Perforated Steel Inserts  <ul style="list-style-type: none"> • 6' rectangular top • Laminate bases with perforated steel inserts • 42" standing height • Ships in three cartons • Simple assembly required Freight Class: 100		M_RB624P	72" X 24" X 42" Cubic Ft: 20 Ship Weight: 264	2611	2650	2689
Rectangular Table, Laminate Bases w/Perforated Steel Inserts  <ul style="list-style-type: none"> • 8' rectangular top • Laminate bases with perforated steel inserts • 42" standing height • Ships in three cartons • Simple assembly required Freight Class: 100		M_RB824P	96" X 24" X 42" Cubic Ft: 22 Ship Weight: 278	2887	2930	2974
Rectangular Table, Laminate Bases w/Perforated Steel Inserts  <ul style="list-style-type: none"> • 6' rectangular top • Laminate bases with perforated steel inserts • 42" standing height • Ships in three cartons • Simple assembly required Freight Class: 125		M_RB630P	72" X 30" X 42" Cubic Ft: 24.5 Ship Weight: 272	2827	2869	2912
Rectangular Table, Laminate Bases w/Perforated Steel Inserts  <ul style="list-style-type: none"> • 8' rectangular top • Laminate bases with perforated steel inserts • 42" standing height • Ships in three cartons • Simple assembly required Freight Class: 125		M_RB830P	96" X 30" X 42" Cubic Ft: 27 Ship Weight: 284	3101	3148	3194
Tapered Top, Perforated Steel Insert Bases, Counter Height						
Tapered Table, Laminate Bases w/Perforated Steel Inserts  <ul style="list-style-type: none"> • 6' tapered top • Laminate bases with perforated steel inserts • 36" counter height • Ships in three cartons • Simple assembly required Freight Class: 100		M_TC636P	72" X 36/24" X 36" Cubic Ft: 22.5 Ship Weight: 252	2643	2683	2722

MEETING TABLES



Zone Pricing	1	2	3
--------------	---	---	---

Tapered Table, Laminate Bases w/ Perforated Steel Inserts

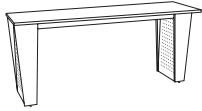

- 8" tapered top
- Laminate bases with perforated steel inserts
- 36" counter height
- Ships in three cartons
- Simple assembly required

Freight Class: 125

M_TC836P	96" X 36/24" X 36"	Cubic Ft: 24	Ship Weight: 264	2864	2907	2950
-----------------	--------------------	--------------	------------------	-------------	-------------	-------------

Tapered Table, Laminate Bases w/ Perforated Steel Inserts

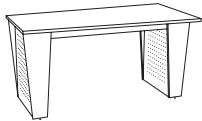

- 6" tapered top
- Laminate bases with perforated steel inserts
- 36" counter height
- Ships in three cartons
- Simple assembly required

Freight Class: 125

M_TC642P	72" X 42/30" X 36"	Cubic Ft: 25.5	Ship Weight: 258	2861	2904	2947
-----------------	--------------------	----------------	------------------	-------------	-------------	-------------

Tapered Table, Laminate Bases w/ Perforated Steel Inserts

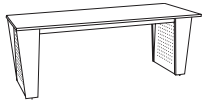

- 8" tapered top
- Laminate bases with perforated steel inserts
- 36" counter height
- Ships in three cartons
- Simple assembly required

Freight Class: 125

M_TC842P	96" X 42/30" X 36"	Cubic Ft: 29	Ship Weight: 270	3105	3152	3198
-----------------	--------------------	--------------	------------------	-------------	-------------	-------------

Tapered Top, Perforated Steel Insert Bases, Standing Height

Tapered Table, Laminate Bases w/ Perforated Steel Inserts

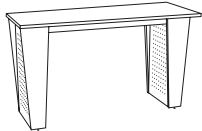

- 6" tapered top
- Laminate bases with perforated steel inserts
- 42" standing height
- Ships in three cartons
- Simple assembly required

Freight Class: 100

M_TB636P	72" X 36/24" X 42"	Cubic Ft: 23	Ship Weight: 270	2822	2864	2907
-----------------	--------------------	--------------	------------------	-------------	-------------	-------------

Tapered Table, Laminate Bases w/ Perforated Steel Inserts



- 8" tapered top
- Laminate bases with perforated steel inserts
- 42" standing height
- Ships in three cartons
- Simple assembly required

Freight Class: 125

M_TB836P	96" X 36/24" X 42"	Cubic Ft: 26	Ship Weight: 282	3041	3087	3132
-----------------	--------------------	--------------	------------------	-------------	-------------	-------------

Tapered Table, Laminate Bases w/ Perforated Steel Inserts

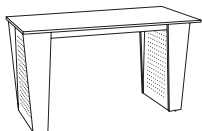

- 6" tapered top
- Laminate bases with perforated steel inserts
- 42" standing height
- Ships in three cartons
- Simple assembly required

Freight Class: 125

M_TB642P	72" X 42/30" X 42"	Cubic Ft: 27.5	Ship Weight: 278	3039	3085	3130
-----------------	--------------------	----------------	------------------	-------------	-------------	-------------

Tapered Table, Laminate Bases w/ Perforated Steel Inserts

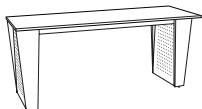

- 8" tapered top
- Laminate bases with perforated steel inserts
- 42" standing height
- Ships in three cartons
- Simple assembly required

Freight Class: 125

M_TB842P	96" X 42/30" X 42"	Cubic Ft: 31	Ship Weight: 290	3282	3331	3380
-----------------	--------------------	--------------	------------------	-------------	-------------	-------------

CHARACTERISTICS

Tops

All tops are 1" thick with thermally fused laminate surface, proper backing and full 3 millimeter PVC AdvantEdge banding as required. High pressure laminate tops available.

Base

Base panels are 1" thick core with thermally fused laminate on both sides and full 3 millimeter PVC AdvantEdge banding as required.

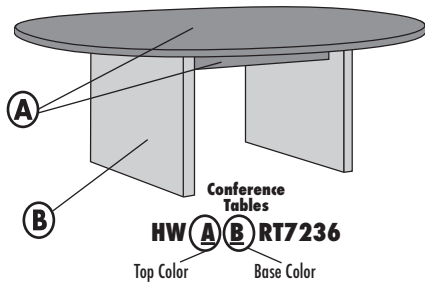

ASSEMBLY

Tables ship with top and base in separate cartons. Assembly is quick and easy by attaching bases to tops with bolts or screws provided.

TABLE FINISH CHART

Code	Finish	Tops	Bases
BW	Boardwalk (Textured)	X	X
DW	Driftwood (Textured)	X	X
E	Black	X	X
FM	Natural Maple	X	X
GP	Graphite	X	X
M	Mahogany*	X	X
SL	Shoreline (Textured)	X	X
WC	Windsor Cherry*	X	X
X	Espresso	X	X

Select a color combination with contrasting top and base, or choose monocolour for same top and base.

Monocolour models use a single finish designator.

*High pressure laminate tops are available in Windsor Cherry and Mahogany.

OPTIONS

- For installed power, see PowerFlex accessories.
- 6.25" thick Box Bases are available. Prices are listed below prices for tables.

Quick Ship is not available on any items ordered with option.

Specifications subject to change without notice.

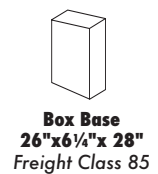
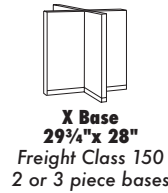
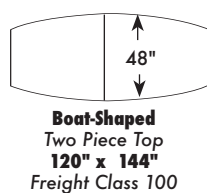
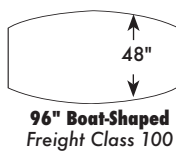
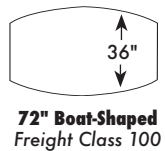
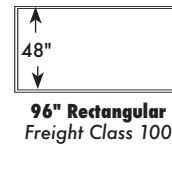
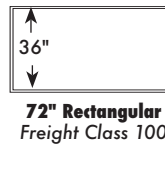
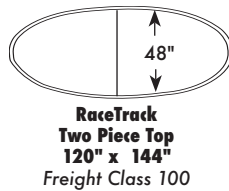
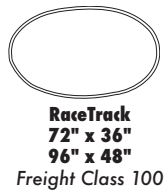
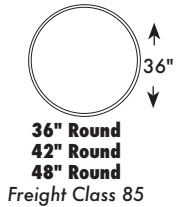

Contemporary Laminate

Round Conference Table



- 1-1/8"-thick top
- X-base for increased stability
- Ships in two cartons
- Assembly required

Code	Dimensions	Cubic Ft.	Ship Weight	783	795	806
HW_TR36	36" X 29"	10.7	85			
HW_TR42	42" X 29"	14.8	109	946	960	974
HW_TR48	48" X 29"	17.1	120	998	1013	1028

RaceTrack Conference Table

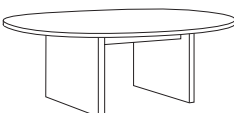

- Contemporary oval shape
- One-piece top, 1-1/8"-thick
- Two support legs
- Ships in two cartons
- Assembly required

Code	Dimensions	Cubic Ft.	Ship Weight	1205	1223	1241
HW_RT7236	72" X 36" X 29"	13.8	144			
				Box Bases B	750	761
					773	



Zone Pricing	1	2	3
--------------	---	---	---

RaceTrack Conference Table

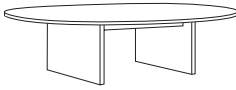

- Contemporary oval shape
- One-piece top 1-1/8"-thick
- Two support legs
- Ships in two cartons
- Assembly required

HW_RT9648	96" X 48" X 29"	Cubic Ft: 21.6	Ship Weight: 225	1419	1440	1462
Box Bases B				750	761	773

RaceTrack Conference Table

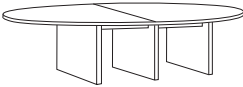

- Contemporary oval shape
- Two-piece top 1-1/8"-thick; wood grain patterns will not match
- Three support legs
- Ships in two cartons
- Assembly required

HW_RT12048	120" X 48" X 29"	Cubic Ft: 27	Ship Weight: 310	1780	1807	1833
HW_RT14448	144" X 48" X 29"	Cubic Ft: 32	Ship Weight: 356	1905	1934	1962
Box Bases B				1150	1167	1185

Boat-Shaped Conference Table

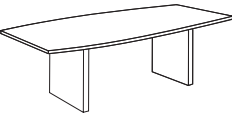

- Boat-shaped top
- One piece top
- Straight legs
- Ships in two cartons
- Assembly required

HW_BT7236	72" X 36" X 29"	Cubic Ft: 13.8	Ship Weight: 144	1205	1223	1241
HW_BT9648	96" X 48" X 29"	Cubic Ft: 21.6	Ship Weight: 225	1419	1440	1462
Box Bases B				750	761	773

Boat-Shaped Conference Table

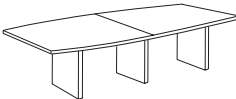

- Boat-shaped 1-1/8" thick top
- Two piece top; wood grain patterns will not match
- Straight legs
- Ships in two cartons
- Assembly required

HW_BT12048	120" X 48" X 29"	Cubic Ft: 27	Ship Weight: 310	1780	1807	1833
HW_BT14448	144" X 48" X 29"	Cubic Ft: 32	Ship Weight: 356	1905	1934	1962
Box Bases B				1150	1167	1185

Rectangular Conference Table

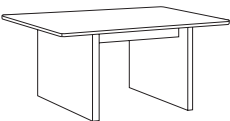

- One-piece top 1-1/8"-thick
- Two support legs
- Ships in two cartons
- Assembly required

HW_T7236	72" X 36" X 29"	Cubic Ft: 13.8	Ship Weight: 159	984	999	1014
HW_T9648	96" X 48" X 29"	Cubic Ft: 21.6	Ship Weight: 245	1262	1281	1300
Box Bases B				750	761	773

Expandable Boat-Shaped Conference Table

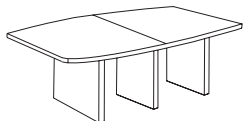

- Boat shaped 1-1/8" thick top
- Two piece top
- Vertical wood grain
- Straight legs
- Ships in two cartons
- Assembly required
- Add extensions to achieve desired width

E_BT4896	96" X 48" X 29"	Cubic Ft: 20	Ship Weight: 278	2227	2260	2294
Box Bases B				1150	1167	1185

Extension for Expandable Boat-Shaped Table

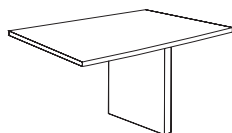

- 48" Table top extension and one straight leg base
- Connects between two-piece top sections of expandable table

E_T4848A	48" X 48" X 29"	Cubic Ft: 12.4	Ship Weight: 138	1224	1242	1261
Box Bases B				375	381	386

CHARACTERISTICS

Top

All tops are 1½"-thick with thermally fused laminate surface, proper backing and full 3 millimeter PVC AdvantEdge banding as required.

Base

Base panels are 1" thick core with thermally fused laminate on both sides and full 3 millimeter PVC AdvantEdge banding as required.

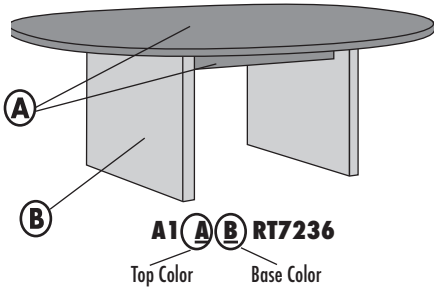

TABLE FINISH CHART

Code	Finish Name	Tops	Bases
FM	Natural Maple	X	X
M	Mahogany	X	X
WC	Windsor Cherry	X	X
BW	Boardwalk (Textured)		X
DW	Driftwood (Textured)		X
E	Black		X
GP	Graphite		X
SL	Shoreline (Textured)		X
X	Espresso		X

Select a color combination with contrasting top and base, or choose monocolour for same top and base. Monocolour models use a single finish designator.

ASSEMBLY

Tables ship with top and base in separate cartons. Assembly is quick and easy by attaching bases to tops with bolts or screws provided.

OPTIONS

For installed power, see PowerFlex accessories. *Specifications subject to change without notice.*

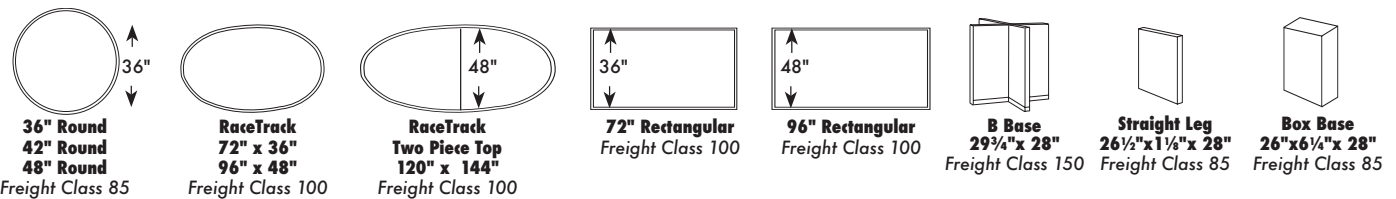

Contemporary Laminate

Round Conference Table



- 1-1/2" thick top
- X base for increased stability
- Ships in two cartons
- Assembly required

Freight Class: 150

RaceTrack Conference Table



- Contemporary oval shape
- One-piece top, 1-1/2" thick
- Two support legs
- Ships in two cartons
- Assembly required

Freight Class: 92.5

Zone Pricing	1	2	3
--------------	---	---	---

A1_TR36	36" X 29.5"	Cubic Ft: 11.1	Ship Weight: 94	955	969	984
A1_TR42	42" X 29.5"	Cubic Ft: 15.3	Ship Weight: 120	1161	1178	1196
A1_TR48	48" X 29.5"	Cubic Ft: 17.8	Ship Weight: 143	1205	1223	1241

A1_RT7236	72" X 36" X 29.5"	Cubic Ft: 13.8	Ship Weight: 175	1262	1281	1300
Box Bases B				750	761	773

RaceTrack Conference Table

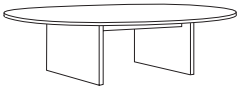

- Contemporary oval shape
- One-piece top, 1-1/2" thick
- Two support legs
- Ships in two cartons
- Assembly required

Freight Class: 92.5

		Zone Pricing		
		1	2	3
A1_RT9648	96" X 48" X 29.5" Cubic Ft: 21.6 Ship Weight: 253	1501	1524	1546
	Box Bases B	750	761	773

RaceTrack Conference Table

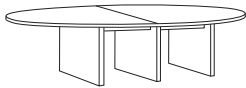

- Contemporary oval shape
- Two-piece top, 1-1/2" thick, wood grain patterns will not match
- Three support legs
- Ships in two cartons
- Assembly required

Freight Class: 92.5

A1_RT12048	120" X 48" X 29.5" Cubic Ft: 27 Ship Weight: 338	1936	1965	1994
A1_RT14448	144" X 48" X 29.5" Cubic Ft: 32 Ship Weight: 380	2095	2126	2158
	Box Bases B	1150	1167	1185

Rectangular Conference Table

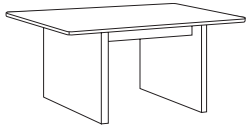

- One-piece top, 1-1/2" thick
- Two support legs
- Ships in two cartons
- Assembly required

Freight Class: 92.5

A1_T7236	72" X 36" X 29.5" Cubic Ft: 13.8 Ship Weight: 178	1195	1213	1231
A1_T9648	96" X 48" X 29.5" Cubic Ft: 21.6 Ship Weight: 273	1458	1480	1502
	Box Bases B	750	761	773

ASSEMBLY

Tables ship with top and base in separate cartons. Assembly is quick and easy by attaching bases to tops with bolts provided.

OPTION

For installed power, see PowerFlex accessories.

PACKING

All units are properly packed in heavy duty cartons with heavy duty corner pads. All packaging conforms to or exceeds specifications as outlined in the Uniform Freight Classification.

Specifications subject to change without notice.

TRANSITIONAL LAMINATE

- Transitional Design
- 1³/₁₆" thick tops with Solid Hardwood Edge
- High-Gloss, High Pressure Laminate surface

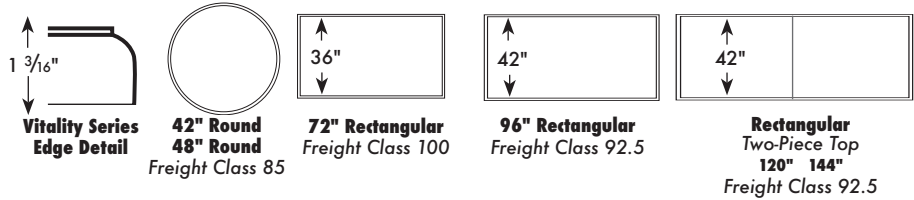

TABLE BASES

Straight Leg, Square and X Bases are 1" thick thermally fused laminate. Cylinder base is veneer panel.

Freight Class is same for 2 or 3 piece bases.



Transitional Laminate

Zone Pricing	1	2	3
--------------	---	---	---

Transitional Round with Cylinder Base

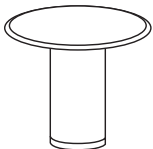

- Vitality design
- High-gloss, HPL top
- Solid hardwood edge
- Sturdy cylinder base
- Ships in two cartons, assembly required

Code	Dimensions	Cubic Ft.	Ship Weight	Zone 1	Zone 2	Zone 3
V_ TR36C	36" X 29"	10.7	126	1796	1823	1850
V_ TR42C	42" X 29"	11.6	150	2129	2161	2193
V_ TR48C	48" X 29"	12.8	162	2319	2354	2389

Transitional Round with X-Base



- Vitality design
- High-gloss, HPL top
- Solid hardwood edge
- Sturdy X-style base
- Ships in two cartons, assembly required

Code	Dimensions	Cubic Ft.	Ship Weight	Zone 1	Zone 2	Zone 3
V_ TR42X	42" X 29"	14.8	100	1296	1315	1335
V_ TR48X	48" X 29"	16.0	112	1507	1530	1552

Transitional Rectangular with Straight Legs

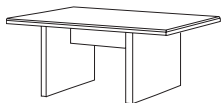

- Vitality design
- High-gloss, HPL top
- Solid hardwood edge
- Straight leg base
- Ships in two cartons

Code	Dimensions	Cubic Ft.	Ship Weight	Zone 1	Zone 2	Zone 3
V_ T72	72" X 36" X 29"	13.8	163	1695	1720	1746
V_ T96	96" X 42" X 29"	17.4	228	2318	2353	2388

Transitional Rectangular with Straight Legs



- Vitality design
- High-gloss, HPL top
- Two-piece top, wood grain pattern will not match
- Solid hardwood edge
- Straight leg base
- Ships in two cartons

Code	Dimensions	Cubic Ft.	Ship Weight	Zone 1	Zone 2	Zone 3
V_ T120	120" X 42" X 29"	27	307	2948	2992	3036
V_ T144	144" X 42" X 29"	32	351	3211	3259	3307

Transitional Rectangular with Cylinder Base



- Vitality design
- High-gloss, HPL top
- Solid hardwood edge
- Cylinder base
- Ships in three cartons (2 pedestal)
- Assembly required

				Zone Pricing	1	2	3
V_ T72CYL	72" X 36" X 29"	Cubic Ft: 31.7	Ship Weight: 310	3814	3871	3928	
V_ T96CYL	96" X 42" X 29"	Cubic Ft: 35.3	Ship Weight: 357	4134	4196	4258	

Transitional Rectangular with Cylinder Base

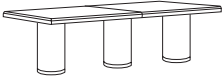

- Vitality design
- High-gloss, HPL top
- Two-piece top, wood grain pattern will not match
- Solid hardwood edge
- Cylinder base
- Ships in four cartons (3 pedestal)
- Assembly required

V_ T120CYL	120" X 42" X 29"	Cubic Ft: 52.4	Ship Weight: 492	5549	5632	5715	
V_ T144CYL	144" X 42" X 29"	Cubic Ft: 56.5	Ship Weight: 536	6211	6304	6397	

ASSEMBLY

Tables ship with top and base in separate cartons. Assembly is quick and easy by attaching bases to tops with bolts provided.

OPTION

Pre-installed Plug-N-Play power/data/phone outlet available. See Conference Accessories for details and pricing.

Quick Ship is not available on any items ordered with option.

PACKING

All units are properly packed in heavy duty cartons with heavy duty corner pads. All packaging conforms to or exceeds specifications as outlined in the Uniform Freight Classification.

Specifications subject to change without notice.

TRADITIONAL LAMINATE

- Traditional Design
- 1³/₁₆" thick tops with Solid Hardwood Edge
- High-Gloss, High Pressure Laminate surface
- Work surface dimensions will vary due to edge profile treatment.

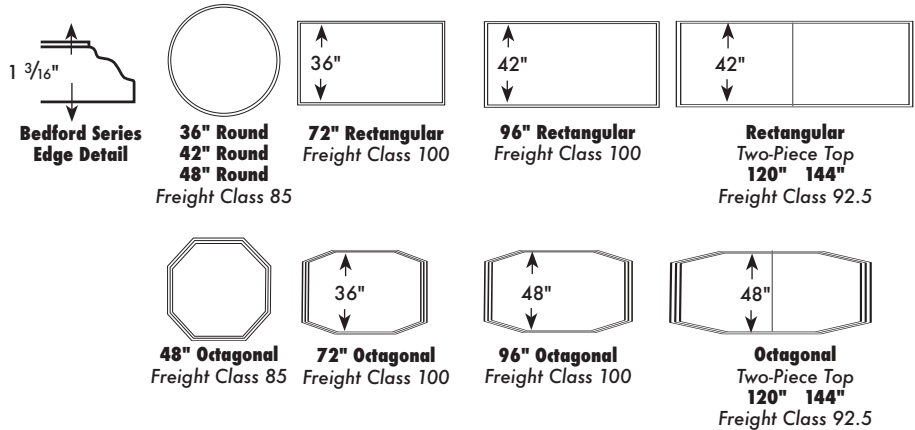

CONFERENCE TABLE BASES

Laminate Bases

Straight Leg and Square Bases are 1" thick thermally fused laminate; traditional design features hardwood base molding. Square Base also includes picture frame molding. Freight Class is the same for 2 or 3 piece bases.

Wood Bases

Queen Anne Style Bases are carved wood four fluted feet with brass foot caps.

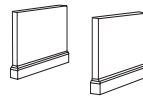

Straight Leg
Traditional
26" x 1 1/8" x 27 1/2"
31 1/2" x 1 1/8" x 27 3/4"
Freight Class 85

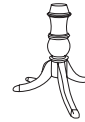

Queen Anne Style
4-Footed Pedestal
34 3/4" x 28 1/2"
Freight Class 300



Square Base
17 1/4" x 27 1/2"
Freight Class 125

Traditional Laminate

Traditional Round with 4-Footed Pedestal



- Bedford design with high-gloss, HPL top
- Shaped hardwood edge
- Queen Anne style carved pedestal fluted legs with brass caps and leg levelers
- Ships in two cartons
- Assembly required

				Zone Pricing		
				1	2	3
TR_TR36	36" X 30"	Cubic Ft: 18.6	Ship Weight: 73	1342	1362	1382
TR_TR42	QS 42" X 30"	Cubic Ft: 18.8	Ship Weight: 85	1655	1680	1705
TR_TR48	QS 48" X 30"	Cubic Ft: 20	Ship Weight: 96	1854	1882	1910

QS FINISHES **M**

Traditional Octagonal with Square Base

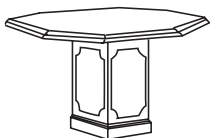

- Bedford design with high-gloss, HPL top
- Shaped hardwood edge
- Square base with traditional base and picture-frame molding
- Ships in two cartons
- Assembly required

TR_TOCT48	QS 48" X 29"	Cubic Ft: 12.8	Ship Weight: 130	1692	1717	1743
------------------	---------------------	----------------	------------------	-------------	-------------	-------------

QS FINISHES **M**

Zone Pricing	1	2	3
--------------	---	---	---

Traditional Octagonal with 4-Footed Pedestal

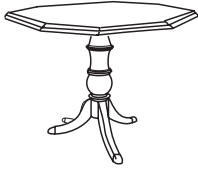

- Bedford design with high-gloss, HPL top
- Shaped hardwood edge
- Queen Anne style carved pedestal fluted legs with brass caps and leg levelers
- Ships in two cartons
- Assembly required

TR_TOCT48P4	48" X 30"	Cubic Ft: 20.4	Ship Weight: 135	2339	2374	2409
--------------------	-----------	----------------	------------------	-------------	-------------	-------------

Rectangular with 4-Footed Pedestal



- Bedford design with high-gloss, HPL top
- Shaped hardwood edge
- Queen Anne style carved pedestal fluted legs with brass caps and leg levelers
- Ships in three cartons (2 pedestal)
- Assembly required

TR_T72P4	72" X 36" X 30"	Cubic Ft: 52.6	Ship Weight: 170	3283	3332	3381
TR_T96P4	96" X 42" X 30"	Cubic Ft: 56.1	Ship Weight: 224	3821	3878	3936

Rectangular with 4-Footed Pedestal



- Same features as above except:
- Two-piece top, wood grain patterns will not match
- Ships in four cartons (3 pedestal)
- Assembly required

TR_T120P4	120" X 42" X 30"	Cubic Ft: 83.6	Ship Weight: 327	6485	6582	6680
TR_T144P4	144" X 42" X 30"	Cubic Ft: 87.7	Ship Weight: 371	7054	7160	7266

Rectangular with Square Base

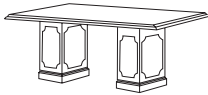

- Bedford design with high-gloss, HPL top
- Shaped hardwood edge
- Square base with traditional base and picture-frame molding
- Ships in three cartons (2 pedestal)
- Assembly required

TR_T72SQ	72" X 36" X 29"	Cubic Ft: 31.8	Ship Weight: 230	2273	2307	2341
TR_T96SQ	96" X 42" X 29"	Cubic Ft: 34.6	Ship Weight: 295	2781	2823	2864

Rectangular with Square Base

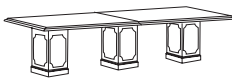

- Same features as above except:
- Two-piece top, wood grain patterns will not match
- Ships in four cartons (3 pedestal)
- Assembly required

TR_T120SQ	120" X 42" X 29"	Cubic Ft: 50.6	Ship Weight: 402	4950	5024	5099
TR_T144SQ	144" X 42" X 29"	Cubic Ft: 54.7	Ship Weight: 446	5579	5663	5746

Rectangular with Straight Legs



- Bedford design with high-gloss, HPL top
- Shaped hardwood edge
- Base molding
- Ships in two cartons
- Assembly required

TR_T72 QS	72" X 36" X 29"	Cubic Ft: 15.3	Ship Weight: 181	1753	1779	1806
TR_T96 QS	96" X 42" X 29"	Cubic Ft: 18.9	Ship Weight: 235	2363	2398	2434





QS FINISHES **M**

Rectangular with Straight Legs

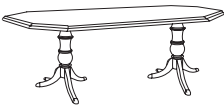
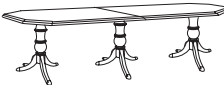
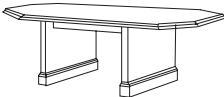

- Same features as above except:
- Two-piece top, wood grain patterns will not match
- Ships in two cartons
- Assembly required

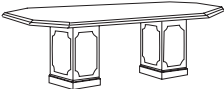
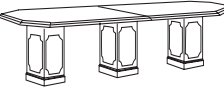

TR_T120	120" X 42" X 29"	Cubic Ft: 27.3	Ship Weight: 322	3988	4048	4108
TR_T144	144" X 42" X 29"	Cubic Ft: 31.6	Ship Weight: 366	4419	4485	4552



				Zone Pricing	1	2	3
Octagonal with 4-Footed Pedestal							
	<ul style="list-style-type: none"> Bedford design with high-gloss, HPL top Shaped hardwood edge Queen Anne style carved pedestal with fluted legs with brass caps and leg levelers Ships in three cartons (2 pedestal) Assembly required 	TR_TOCT72P4 72" X 36" X 30" Cubic Ft: 52.6 Ship Weight: 176	3359	3409	3460		
		TR_TOCT96P4 96" X 48" X 30" Cubic Ft: 55.3 Ship Weight: 245	3862	3920	3978		
Octagonal with 4-Footed Pedestal							
	<ul style="list-style-type: none"> Same features as above except: Two-piece top, wood grain patterns will not match Ships in four cartons (3 pedestal) Assembly required 	TR_TOCT120P4 120" X 48" X 30" Cubic Ft: 80.8 Ship Weight: 340	6441	6538	6634		
		TR_TOCT144P4 144" X 48" X 29" Cubic Ft: 84.4 Ship Weight: 416	7027	7132	7238		
Octagonal with Straight Legs							
	<ul style="list-style-type: none"> Bedford design with high-gloss, HPL top Shaped hardwood edge Base molding Ships in two cartons Assembly required 	TR_TOCT72LG 72" X 36" X 29" Cubic Ft: 15.3 Ship Weight: 175	1906	1935	1963		
		TR_TOCT96LG 96" X 48" X 29" Cubic Ft: 18.1 Ship Weight: 244	2461	2498	2535		
Octagonal with Straight Legs							
	<ul style="list-style-type: none"> Same features as above except: Two-piece top, wood grain patterns will not match Ships in three cartons Assembly required 	TR_TOCT120LG 120" X 48" X 29" Cubic Ft: 24.2 Ship Weight: 319	4408	4474	4540		
		TR_TOCT144LG 144" X 48" X 29" Cubic Ft: 27.8 Ship Weight: 362	4848	4921	4993		
Octagonal with Square Base							
	<ul style="list-style-type: none"> Bedford design with high-gloss, HPL top Shaped hardwood edge Square base with traditional base and picture-frame molding Ships in three cartons (2 pedestal) Assembly required 	TR_TOCT72 72" X 36" X 29" Cubic Ft: 31.0 Ship Weight: 214	2332	2367	2402		
		TR_TOCT96 QS 96" X 48" X 29" Cubic Ft: 33.9 Ship Weight: 283	2843	2886	2928		
				QS FINISHES	M		
Octagonal with Square Base							
	<ul style="list-style-type: none"> Same features as above except: Two-piece top, wood grain patterns will not match Ships in four cartons (3 pedestal) Assembly required 	TR_TOCT120 120" X 48" X 29" Cubic Ft: 47.8 Ship Weight: 359	4913	4987	5060		
		TR_TOCT144 144" X 48" X 29" Cubic Ft: 51.5 Ship Weight: 442	5543	5626	5709		
Expandable Traditional Table							
	<ul style="list-style-type: none"> 1-3/16" thick two-piece top with vertical wood grain Bedford design with high-gloss, HPL top Shaped hardwood edges Three straight legs with traditional base molding Ships in 2 cartons Assembly required Add extensions to achieve desired width 	TE_T4896 96" X 48" X 29" Cubic Ft: 20 Ship Weight: 316	3341	3391	3441		
Extension for Traditional Table							
	<ul style="list-style-type: none"> 1-3/16" thick top with vertical wood grain Bedford design with high-gloss, HPL top Shaped hardwood edges One straight leg with traditional base molding 	TE_T4848A 48" X 48" X 29" Cubic Ft: 12.4 Ship Weight: 149	1615	1639	1663		

FINISH SELECTION

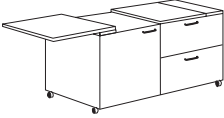
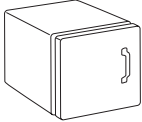
BLACK **E** | BOARDWALK **BW** | DRIFTWOOD **DW** |
 ESPRESSO **X** | GRAPHITE **GP** | MAHOGANY **M** | NATURAL
 MAPLE **FM** | SHORELINE **SL** | WINDSOR CHERRY **WC** |

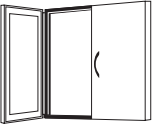
SIN 711-9 ACCESSORIES

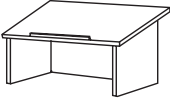
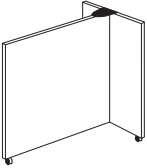
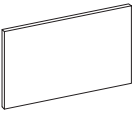
		Zone Pricing	1	2	3
 <p>Mobile Server Credenza</p> <ul style="list-style-type: none"> • Flip-open top with concealed hinges extend surface to 72"W and 31.75"H • Inside Drawer Dimensions: 20" x 18" x 13" top right (stores 2 liter bottles upright) • 20" x 18" x 8" bottom right • Inside compartment dimensions: 22" x 21" x 24" left side • Door compartment includes nine holes for ventilation of small refrigerator • Casters for mobility <p>Freight Class: 125</p>	SIN 711-9				
	H_2248 48/72" X 24.5" X 30.75" Cubic Ft: 25.3 Ship Weight: 228	1719	1745	1771	
	Pulls: BRUSHED CHROME HW EBONY HE BRIGHT BRASS HB OVAL NICKEL HD T-Bar Nickel HV				
 <p>Compact Refrigerator</p> <ul style="list-style-type: none"> • Small ice tray compartment • 2 removable shelves • Requires 120 volt grounded electrical outlet • Do not use extension cord <p>Freight Class: 92.5</p>	SIN 711-9				
	SERVERFRIDGE 19" X 20.5" X 16" Cubic Ft: 4.2 Ship Weight: 46	854	867	880	
 <p>Mobile Server Cart</p> <ul style="list-style-type: none"> • Flip-open top extends top surface to 36.25"W and 31.75"H • Top drawer 20" x 18" x 13"H stores 2-liter soda bottles upright • Bottom drawer 20" x 18" x 8"H • Casters for mobility • 3/8" thick drawer bottoms <p>Freight Class: 100</p>	SIN 711-9				
	H_2224 24.25" X 24.5" X 30.75" Cubic Ft: 16.7 Ship Weight: 150	1516	1539	1561	
	Pulls: BRUSHED CHROME HW EBONY HE BRIGHT BRASS HB OVAL NICKEL HD T-Bar Nickel HV				
 <p>TR_MB Marker Board</p> <ul style="list-style-type: none"> • Marker board 45" x 42" inside • Eraser and marker kit included • Reverse-side of doors feature grey fabric-covered tackable surface • Magnetic door catches • Optional pre-installed projection screen; add P to model number-see below for pricing • TR/MB - Mahogany • TR/WCMB - Windsor Cherry <p>Freight Class: 100</p>	TR_MB 48" x 4.5" x 48" Cubic Ft: 12.2 Ship Weight: 141	1290	1309	1329	
 <p>Marker Board</p> <ul style="list-style-type: none"> • Marker board 45" x 42" inside • Eraser and marker kit included • Reverse-side of doors feature grey fabric-covered tackable surface • Magnetic door catches • Optional pre-installed Projection Screen available; add "P" to model number <p>Freight Class: 100</p>	H_MB 48" X 4.5" X 48" Cubic Ft: 12.2 Ship Weight: 141	1290	1309	1329	
	Pulls: BRUSHED CHROME HW EBONY HE BRIGHT BRASS HB OVAL NICKEL HD T-Bar Nickel HV				
<p>Projection Screen</p> <ul style="list-style-type: none"> • Roll down projector screen fits inside Marker Board • Requires removal of fascia board for installation <p>Freight Class: 125</p>	PROJECTSCREEN 40" X 48" Cubic Ft: 1.2 Ship Weight: 5	157	159	162	

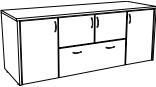
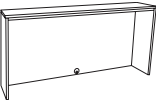
		Zone Pricing	1	2	3
Standing Lectern  <ul style="list-style-type: none"> • Pencil/document catch on angled surface • 2 storage shelves for presentation materials • 4 casters included for field installation, 2 locking 		HW_LS46C 24" X 15" X 46" Cubic Ft: 13.8 Ship Weight: 83	803	815	827
Freight Class: 125					
Table Top Lectern  <ul style="list-style-type: none"> • Fits on any table top • Hardwood pencil/document ledge • Mar-resistant laminate finish • Non-skid gasket on bottom edges 		HW_LS18 24" X 14" X 18" Cubic Ft: 5 Ship Weight: 20	422	428	435
Freight Class: 125					
Mobile Teaming Board  <ul style="list-style-type: none"> • Dry-Erase whiteboard both sides • Includes markers, eraser and mountable holder • Tackboard available below • Assembly required • Casters for mobility 		HW_MTB 49" x 24" x 72" Cubic Ft: 13.2 Ship Weight: 178	1201	1219	1237
Freight Class: 100					
Tackboard for Mobile Teaming Board  <ul style="list-style-type: none"> • Fully tackable surface • Core 952 Macro fabric • Mounts to Mobile Teaming Board 		HW_MTBTB 47.5" x 35.5" Cubic Ft: 3.1 Ship Weight: 20	524	532	540
Freight Class: 100					
Buffet Credenza, 4 Drawer, 4 Storage  <ul style="list-style-type: none"> • Four drawers in top • Two storage compartments with one adjustable shelf each behind four doors • 36" buffet height 		H_ _4D4SBC 63.5" x 24" x 36" Cubic Ft: 41 Ship Weight: 365	2537	2575	2613
Freight Class: 125					
Buffet Credenza with Bookcase Storage  <ul style="list-style-type: none"> • Storage compartment behind two doors top/center (36"W x 21"D x 12"H) • Lateral file drawer with filing hardware bottom/center • Bookcase storage compartments with one adjustable shelves behind doors on right and left sides 		H_ _754 72" x 24" x 29" Cubic Ft: 39 Ship Weight: 375	2419	2455	2492
Freight Class: 125					
Video Overhead Cabinet  <ul style="list-style-type: none"> • Open cabinet for video/TV monitor • One grommet in center/bottom • Inside dimensions are 70"W x 15"D x 33"H 		H_717-0 72" x 16" x 36.5" Cubic Ft: 31.4 Ship Weight: 168	898	911	925
Freight Class: 125					

Zone Pricing	1	2	3
--------------	---	---	---

Left Storage Tower



- Full-height door hinged on left
- Four adjustable shelves

Freight Class: 125

H_6518SL	18" x 24" x 65.5"	Cubic Ft: 22.3	Ship Weight: 189	1421	1442	1464
-----------------	-------------------	----------------	------------------	-------------	-------------	-------------

Right Storage Tower



- Full-height door hinged on right
- Four adjustable shelves

Freight Class: 125

H_6518SR	18" x 24" x 65.5"	Cubic Ft: 22.3	Ship Weight: 189	1421	1442	1464
-----------------	-------------------	----------------	------------------	-------------	-------------	-------------

Traditional Buffet Credenza, 4 Drawer, 4 Storage

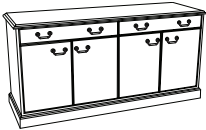

- Two drawers in top
- Two storage compartments with one adjustable shelf each behind four doors
- 36" buffet height

Freight Class: 125

TR_734BC	72" x 24" x 36"	Cubic Ft: 46	Ship Weight: 388	3015	3060	3105
-----------------	-----------------	--------------	------------------	-------------	-------------	-------------

Tripod Portable Power Base

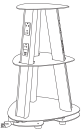

- 9 power outlets
- 6 active USB ports
- ECIB = Black, ECIS = Silver, ECIW = White

Freight Class: 125

SIN 711-99

		Zone Pricing		
		1	2	3
ECIB108	18"W X 18"D X 25.5"H Cubic Ft: 6 Ship Weight: 39	2498	2535	2573
ECIS108	18"W X 18"D X 25.5"H Cubic Ft: 6 Ship Weight: 39	2498	2535	2573
ECIW108	18"W X 18"D X 25.5"H Cubic Ft: 6 Ship Weight: 39	2498	2535	2573

Marina™ HDMI Collaborative Technology

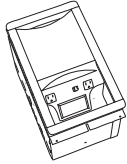

- Self-contained collaborative meeting solution
- Sliding doors for easy access to power receptacles and USB ports
- HDMI/AV cables for up to 4 users
- ETL Listed
- Must be factory installed

SIN 711-99

MARW	Gloss White 13.2"W X 8"D X 9.4"H Ship Weight: 20	8347	8472	8597
MARS	Silver Pearl 13.2"W X 8"D X 9.4"H Ship Weight: 20	8347	8472	8597
MARB	Black 13.2"W X 8"D X 9.4"H Ship Weight: 20	8347	8472	8597

Surface Power Module



- 1 power outlet
- 2 active USB ports
- 72" cord with molded plug
- Mounts above or below desk tops
- Can be installed in laminate tables
- Includes brackets to mount on desk tops, minimum thick .75", maximum 1.75"
- Easily retrofits to existing furniture
- SB = Black, SS = Silver, SW = White

SIN 711-99

SB	3.5"W X 2.2"D X 2.5"H Cubic Ft: 1 Ship Weight: 1	427	433	440
SS	3.5"W X 2.2"D X 2.5"H Cubic Ft: 1 Ship Weight: 1	427	433	440
SW	3.5"W X 2.2"D X 2.5"H Cubic Ft: 1 Ship Weight: 1	427	433	440

Flush Mount Power Base

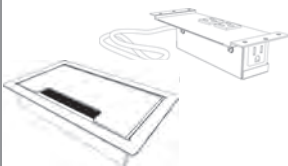

- 2 power outlets in top and one convenience outlet below surface
- 72" cord with molded plug
- Mounts in desk tops and select lounge/reception seating
- Matching flush grommet
- Must be factory installed
- Add item # suffix to end of standard HPFI item
- FB = Black, FS = Silver, FW = White
- Contact HPFI for additional options

SIN 711-99

FB	5.7"W X 3.4"D X 2.2"H Ship Weight: 2	320	325	330
FS	5.7"W X 3.4"D X 2.2"H Ship Weight: 2	320	325	330
FW	5.7"W X 3.4"D X 2.2"H Ship Weight: 2	347	352	357

Cove™ Flush Mount Charging



- Two 110 volt power outlets and two active USB charging ports
- Can be factory installed in table/desk tops, side surfaces or in select reception seating
- Spill-resistant receptacles
- 108" cord
- 90° flat plug with 45° rotation

SIN 711-99

CW	Gloss White 5.75"W X 2.5"D X 3.25"H Ship Weight: 2.25	465	472	479
CS	Silver Pearl 5.75"W X 2.5"D X 3.25"H Ship Weight: 2.25	465	472	479
CB	Black 5.75"W X 2.5"D X 3.25"H Ship Weight: 2.25	465	472	479

Cove Round Series™

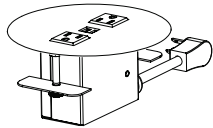

- The Cove™ Round Series features an all new sleek round faceplate to compliment a wide range of furniture designs. Choose from power only or power with USB configurations.
- Spill resistant receptacles for an added level of safety against spill and other hazards.
- 110 volt power outlets.
- 2.1-amp USB charging ports to charge devices like tablets and mobile phones, even while in use.
- Factory installed face-up or in the side of table surface.

SIN 711-99

CR1	1 Power, 2 USB 6" Diameter X 3.25"H Ship Weight: 3	439	446	452
White - CR1W, Silver Pearl - CR1S, Black - CR1B				
CR2	2 Power, 2 USB 6" Diameter X 3.25"H Ship Weight: 3	465	472	479
White - CR2W, Silver Pearl - CR2S, Black - CR2B				
CRP	2 Power Only 6" Diameter X 3.25"H Ship Weight: 3	309	314	318
White - CRPW, Silver Pearl - CRPS, Black - CRPB				

Wireless Charging Pad with 2 Power Outlets



- 2 power outlets
- 72" cord with molded plug
- Mounts in desk tops or table tops only
- Requires Qi charger sleeve for mobile devices
- 2 utility outlets below
- Must be factory installed
- Add item # suffix to end of standard HPFI item
- WB = Black, WS = Silver

SIN 711-99

WB	10.25"W X 4.75"D X 2.2"H Ship Weight: 2.5	1305	1325	1344
WS	10.25"W X 4.75"D X 2.2"H Ship Weight: 2.5	1305	1325	1344

Drifter™ Table Top Power And Charging Hub



- Unique portable charging hub
- Sits on desk or table top with 360° access
- 3 power outlets and 3 active USB ports
- Built-in cord management
- 108" cord
- Includes kit to secure to worksurface when mobility is not desired
- DB = Black, DS = Silver, DW = Gloss White

SIN 711-99

		Zone Pricing		
		1	2	3
DW	10" W X 10" D x 2.85" H Cubic Ft: 1 Ship Weight: 6	895	908	922
DS	10" W X 10" D x 2.85" H Cubic Ft: 1 Ship Weight: 6	895	908	922
DB	10" W X 10" D x 2.85" H Cubic Ft: 1 Ship Weight: 6	865	908	922

Plug-n-Play

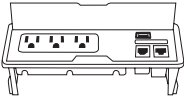

- Conference table application
- Installed, specify location on table for installation
- Three power outlets
- One data (RJ45) hookup
- One phone (RJ11) hookup
- Flip-open cover
- USB port
- 10' electrical cord

SIN 711-99

PNP	7.75" X 2.75" X 1.75" Ship Weight: 2	196	199	202
------------	--------------------------------------	------------	------------	------------

Freight Class: 75

CHARACTERISTICS

Clique training tables provide maximum flexibility, versatility and a modern aesthetic with multiple top shapes and sizes to allow for almost unlimited configurations. Choose top shapes and legs (with or without locking casters) to fit the desired configuration or layout. Assembly is simple and quick. Add modesty panels or privacy screens to complete your customized configuration.

TOPS

- 1-1/8" thick thermal fused laminate tops are available in a nine color palette with matching 3mm edge banding with a soft radius corners
- 1-1/8" thick High-pressure laminate tops with matching edge band with soft radius corners are available for a 15% upcharge in Mahogany or Windsor Cherry. A six-week lead time will apply. Add 4 after the CT in the top model number. Contact your customer service representative to obtain delivery quotes
- Table tops on legs will be 29" high
- Simple assembly is required

BASES

- Black 60mm steel post legs with casters or levelers
- Legs available in sets of four legs with locking casters, four legs with levelers, or set of four legs – two with casters and two stationary legs with levelers
- Legs also sold individually with levelers or with locking casters

MODESTY PANEL

- 8" raised satin acrylic modesty panel

PRIVACY SCREEN

- Acrylic table top privacy screen is self-standing with anti-skid bottom surface

CARE AND CLEANING INSTRUCTIONS

Normal cleaning: Clean using a soft cloth and a good window cleaner, which contains no ammonia, followed by wiping dry using a dry soft cloth.



Training Tables Tops

Zone Pricing

1

2

3

20" Rectangular Top

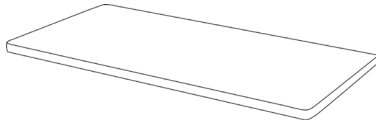

Model	Dimensions	Cubic Ft.	Ship Weight	Zone 1	Zone 2	Zone 3
CT_3620T	36" X 20" X 1-1/8"	2	30	343	348	353
CT_4820T	48" X 20" X 1-1/8"	3.2	40	384	390	396
CT_6020T	60" X 20" X 1-1/8"	4	50	484	491	499
CT_7220T	72" X 20" X 1-1/8"	4.7	64	520	528	536

24" Rectangular Top

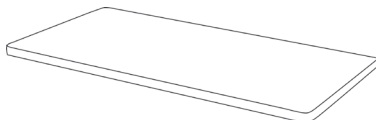

Model	Dimensions	Cubic Ft.	Ship Weight	Zone 1	Zone 2	Zone 3
CT_3624T	36" X 24" X 1-1/8"	2.8	35	373	379	384
CT_4824T	48" X 24" X 1-1/8"	2.8	45	398	404	410
CT_6024T	60" X 24" X 1-1/8"	3.5	56	484	491	499
CT_7224T	72" X 24" X 1-1/8"	4.1	69	534	542	550

30" Rectangular Top

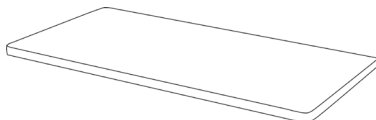

Model	Dimensions	Cubic Ft.	Ship Weight	Zone 1	Zone 2	Zone 3
CT_3630T	36" X 30" X 1-1/8"	3.3	40	419	425	432
CT_4830T	48" X 30" X 1-1/8"	3.3	56	449	456	462
CT_6030T	60" X 30" X 1-1/8"	4.1	69	514	522	529
CT_7230T	72" X 30" X 1-1/8"	4.9	83	575	584	592

Half Round Top



Model	Dimensions	Cubic Ft.	Ship Weight	Zone 1	Zone 2	Zone 3
CT_4020H	36" X 20" X 1-1/8"	2.8	40	479	486	493
CT_4824H	48" X 24" X 1-1/8"	2.8	45	601	610	619
CT_6030H	60" X 30" X 1-1/8"	4.1	65	680	690	700

Crescent Top



Model	Dimensions	Cubic Ft.	Ship Weight	Zone 1	Zone 2	Zone 3
CT_3620C	36" X 20" X 1-1/8"	3.1	44	465	472	479
CT_4220C	40" X 20" X 1-1/8"	3.5	56	631	640	650
CT_4824C	48" X 24" X 1-1/8"	5.3	70	746	757	768
CT_4830C	48" X 30" X 1-1/8"	5.3	80	746	757	768



Zone Pricing	1	2	3
--------------	---	---	---

Trapezoid Top



CT_3620Z	36" X 20" X 1-1/8"	Cubic Ft: 2	Ship Weight: 28	439	446	452
CT_4824Z	48" X 24" X 1-1/8"	Cubic Ft: 2.8	Ship Weight: 40	475	482	489
CT_6030Z	60" X 30" X 1-1/8"	Cubic Ft: 4.1	Ship Weight: 66	594	603	612

60" Slice Top, 60 Degree

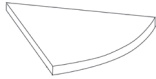

CT_20S60T	20" X 1-1/8"	Cubic Ft: 3	Ship Weight: 14	479	486	493
CT_24S60T	24" X 1-1/8"	Cubic Ft: 3	Ship Weight: 19	504	512	519

90" Slice Top 90 Degree

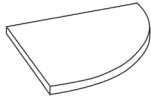

CT_20S90T	20" X 1-1/8"	Cubic Ft: 3	Ship Weight: 16	495	502	510
CT_24S90T	24" X 1-1/8"	Cubic Ft: 3	Ship Weight: 24	514	522	529

Square Top



CT_S30T	30" X 30" X 1-1/8"	Cubic Ft: 3	Ship Weight: 40	409	415	421
CT_S36T	36" X 36" X 1-1/8"	Cubic Ft: 3.1	Ship Weight: 48	445	452	458
CT_S42T	42" X 42" X 1-1/8"	Cubic Ft: 4	Ship Weight: 65	484	491	499

Round Top



CT_R30T	30" D X 1-1/8"	Cubic Ft: 3	Ship Weight: 35	525	533	541
CT_R36T	36" D X 1-1/8"	Cubic Ft: 3.1	Ship Weight: 44	601	610	619
CT_R42T	42" D X 1-1/8"	Cubic Ft: 4	Ship Weight: 56	667	677	687
CT_R48T	48" D X 1-1/8"	Cubic Ft: 4.5	Ship Weight: 67	767	779	790

Bases

1 Black Steel Post leg, leveler



MLB1L	60 mm x 28"H	Cubic Ft: 1	Ship Weight: 5	106	108	109
--------------	--------------	-------------	----------------	------------	------------	------------

- One 60 mm steel post leg with leveler
- Easy attachment to table top

1 Black Steel Post leg, caster



MLB1C	60 mm x 28"H	Cubic Ft: 1	Ship Weight: 5	106	108	109
--------------	--------------	-------------	----------------	------------	------------	------------

- One 60 mm steel post leg with locking caster
- Easy attachment to table top

4 Black Steel Post legs, casters

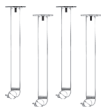

MLB4C	60 mm x 28"H	Cubic Ft: 1	Ship Weight: 20	306	311	315
--------------	--------------	-------------	-----------------	------------	------------	------------

- Four 60 mm steel post legs with locking casters
- Easy attachment to table top

4 Black Steel Post legs, levelers



MLB4L	60 mm x 28"H	Cubic Ft: 1	Ship Weight: 20	306	311	315
--------------	--------------	-------------	-----------------	------------	------------	------------

- Four 60 mm steel post legs with levelers

4 Black Steel Post legs, 2 casters, 2 levelers



MLB2C2L	60 mm x 28"H	Cubic Ft: 1	Ship Weight: 20	306	311	315
----------------	--------------	-------------	-----------------	------------	------------	------------



- Two 60 mm steel post legs with locking casters
- Two legs with levelers
- Easy attachment to table top

Black Steel X-Base, levelers



AVRBASE	32" X 32" X 28"	Cubic Ft: 10.5	Ship Weight: 20	223	226	230
----------------	-----------------	----------------	-----------------	------------	------------	------------

- Black steel x-base
- Four levelers
- Easily attaches to round or square table top; or 30" deep tops
- For 60" or 72" wide tops, use 2 bases

Modesty Panel				Zone Pricing	1	2	3
Modesty Panel 	XDAMP36	36" x 8"	Cubic Ft: 2.1 Ship Weight: 10	242	246	249	
	XDAMP42	42" x 8"	Cubic Ft: 2.1 Ship Weight: 11	247	251	254	
	XDAMP48	48" x 8"	Cubic Ft: 2.1 Ship Weight: 12	252	256	260	
	<ul style="list-style-type: none"> Satin acrylic modesty panel Attaches to rectangular table top of same width 						
Privacy Screen							
Privacy Screen 	XDSC36	36" x 8"	Cubic Ft: 2.1 Ship Weight: 10	349	354	359	
	XDSC42	42" x 8"	Cubic Ft: 2.1 Ship Weight: 11	359	364	370	
	XDSC48	48" x 8"	Cubic Ft: 2.1 Ship Weight: 12	363	368	374	
	<ul style="list-style-type: none"> Satin acrylic screen Screen is fixed to table surface with hardware furnished 						



CHARACTERISTICS

Deflection tables feature a tilting top that allows tables to be nested for ease of movement and compact storage. Pull them out and set up when needed, tuck them away when the meeting is over.

- Tilt-top feature
- 1-1/8" thermal fused laminate tops are offered in a broad nine-color palette with matching 3mm edge banding
- High pressure laminate tops with matching or black edge available for a 15% upcharge. A six-week lead time will apply
- Metal T-legs legs available in **Black**
- Includes **4 casters**--2 locking
- Table height of 30"
- Available in 48", 60" or 72" widths with a choice of 24" or 30" depth
- Color coordinated modesty panel is standard
- Some assembly required

DEFLECTION ITEM NUMBER FORMAT

ItemNumber-
 Top Type-
 Top Color-
 Leg Style (always **2**)-
 Leg Color (always **E**)-
Item Number Example:
DT4824RC 1 M 2 E

TOP SHAPE

RC Rectangular

TOP TYPE

- 1** 1-1/8" Thermally fused laminate with matching 3mm edge band with soft radius edges.
- 2** 1-1/8" High pressure laminate with black FB flat standard. 15% upcharge. Available only in **Mahogany** and **Windsor Cherry**.
- 4** 1-1/8" High pressure laminate top with matching 3mm edge with soft radius corners. 15% upcharge. Available only in **Mahogany** and **Windsor Cherry**.

TOP FINISH OPTIONS

- E** Black
 - BW** Boardwalk (textured)
 - DW** Driftwood (textured)
 - FM** Natural Maple
 - GP** Graphite
 - M** Mahogany*
 - SL** Shoreline (textured)
 - WC** Windsor Cherry*
 - X** Espresso
- *Available in high pressure laminate tops*

LEG STYLE

2 T-leg tilt top

LEG COLOR

E Black

QUICKSHIP

Quick Ship is not available on any items ordered with option.

CARE AND CLEANING INSTRUCTIONS

Normal cleaning: Clean using a soft cloth and a good window cleaner which contains no ammonia, followed by wiping dry using a dry soft cloth.

Specifications subject to change without notice.



Tilt-Top Training Tables

Rectangular Tilt-Top Training Table

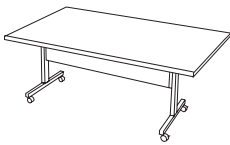

- 24" Deep folding rectangular table
- Metal T-legs available in Black
- Includes 4 casters, 2 locking
- Assembly required

Freight Class: 100

Rectangular Tilt-Top Training Table

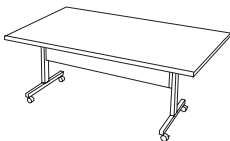

- 30" Deep folding rectangular table
- Metal T-legs available in Black
- Includes 4 casters, 2 locking
- Assembly required

Freight Class: 100

Zone Pricing	1	2	3
DT4824RC__2E 48" X 24" X 30" Cubic Ft: 7 Ship Weight: 87	694	704	715
DT6024RC__2E 60" X 24" X 30" Cubic Ft: 9.4 Ship Weight: 102	765	776	788
DT7224RC__2E 72" X 24" X 30" Cubic Ft: 11.3 Ship Weight: 116	808	820	832
DT4830RC__2E 48" X 30" X 30" Cubic Ft: 9.4 Ship Weight: 110	721	732	743
DT6030RC__2E 60" X 30" X 30" Cubic Ft: 11.4 Ship Weight: 120	792	804	816
DT7230RC__2E 72" X 30" X 30" Cubic Ft: 13.6 Ship Weight: 132	848	861	873

The Milan Bistro Table collection is the perfect solution for break rooms, cafeterias, dining areas and anywhere that you need a place to meet and eat. A large variety of top options designed to coordinate with other HPFi furnishings. Combine any table top with a 28" high or 40.75" high heavy-duty steel base to create an ideal environment. Choose from a wide range of Milan Bistro Seating in Breakroom Seating for an instant lunch area or sidewalk café.

CHARACTERISTICS

TOPS:

- Atlas tops are 1½" thick thermally fused laminate with matching 3 millimeter PVC AdvantEdge banding. 36" or 42" diameter round tops are available in Natural Maple (FM), Windsor Cherry (WC) or Mahogany (M)
- Hyperwork tops are 1-1/8" thick thermally fused laminate with matching 3 millimeter PVC AdvantEdge banding. 36" or 42" diameter round tops are available in Natural Maple (FM), Windsor Cherry (WC), Mahogany (M), Graphite (GP), Espresso (X), Black (E), Boardwalk (BW), Driftwood (DW) and Shoreline (SL)

BASES:

- 28" high steel base column is 3" in diameter supported by a 30" diameter heavy-duty metal disc base with easy adjustable leveling glides. Overall table height with top is 29"-29½".
- 40¾" high steel base column is 3" in diameter with foot ring for bistro height seating. Column and foot ring supported by a 30" diameter heavy-duty metal disc base with easy adjustable leveling glides. Overall table height with top is 41¾"-42½".



ASSEMBLY

Simple assembly is required to connect table tops to bases with a screwdriver. All necessary attaching hardware is provided.

See Milan chairs in Breakroom Seating.

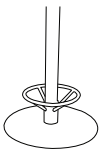
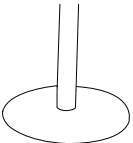
		Zone Pricing	1	2	3
MILAN TABLES					
Table Base for 42" High Table  Freight Class: 250	BTR536TB 30" X 30" X 40.75" Cubic Ft: 30 Ship Weight: 90	755	766	778	
Table Base for 29" High Table  Freight Class: 250	BTR534TB 30" X 30" X 28" Cubic Ft: 21 Ship Weight: 70	556	564	573	

Round Atlas Table Top

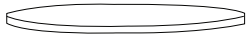

- 1.5" thick round table top for Milan table bases
- Thermally fused laminate top
- Easy attachment to Milan table bases
- 3 millimeter PVC AdvantEdge banding
- Tops available in Natural Maple (FM), Windsor Cherry (WC) and Mahogany (M)

SIN 711-11
Freight Class: 85

Round Hyperwork Table Top

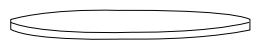

- 1.125" thick round table top for Milan table bases
- Thermally fused laminate top
- Easy attachment to Milan table bases
- 3 millimeter PVC AdvantEdge banding
- Tops available in Hyperwork finishes: Mahogany (M), Windsor Cherry (WC), Espresso (X), Natural Maple (FM), Graphite (GP), Black (E), Boardwalk (BW), Driftwood (DW) and Shoreline (SL)

SIN 711-11
Freight Class: 85

				Zone Pricing	1	2	3
A1_R36T	36" X 36" X 1.5"	Cubic Ft: 3.6	Ship Weight: 59	578	587	595	
A1_R42T	42" X 42" X 1.5"	Cubic Ft: 4.7	Ship Weight: 75	686	696	707	
<hr/>							
H_R36T	36" X 36" X 1.125"	Cubic Ft: 3	Ship Weight: 44	521	529	537	
H_R42T	42" X 42" X 1.125"	Cubic Ft: 4	Ship Weight: 56	618	627	637	

OCCASIONAL TABLES SIN 711-11

OCCASIONAL TABLES

Malibu Collection

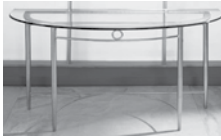

Malibu occasional tables blend classic materials, steel and glass, to provide unique accents in a wide range of environments. Bases are built with tapered steel legs. Choose glass or laminate top.

Trados Metal Collection

Trados Metal occasional tables feature tubular steel base with a brushed aluminum powdercoat finish with a urethane clear coat. Choose glass or laminate top.



6700 Collection

Tapered-leg occasional tables that blend harmoniously with traditional or modern interiors, **6700** tables are available with veneer or laminate tops.



Hyperwork Collection

High-quality, high-value contemporary tables for fast-paced business environments. Angled satin finish chrome legs add visual interest.



9100 Collection

9100 occasional tables feature veneer tops and the natural beauty of wood. Tops feature radius corners, ideal for waiting room environments.

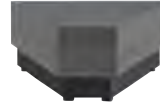

7400 Modular Collection

The **7400** two-tier base creates heavy-duty frame for long-term use. Recessed plinth bases reduce scuffs and feature a textured, black vinyl surface that resists scratches.

Marquet Collection

Marquet table tops feature cherry, maple and walnut veneer in unique pattern influenced by traditional marquetry designs.



Bedford Collection

Bedford, an occasional table collection of traditional designs responds to the demands of the modern office. High pressure laminate top, 1-3/16" thick, has shaped edges.

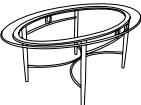

Malibu		Zone Pricing		1	2	3
5923MET End Table	 <ul style="list-style-type: none"> • Round 3/8" thick clear glass top • Tapered-leg 16 gauge steel base • Brushed aluminum powdercoat finish with a urethane clear coat • Protective floor caps 	28" X 28" X 24"	Cubic Ft: 16 Ship Weight: 43	815	827	839
QS Freight Class: 250						
5920MET Coffee Table	 <ul style="list-style-type: none"> • Oval 3/8" thick clear glass top • Tapered-leg 16 gauge steel base • Brushed aluminum powdercoat finish with a urethane clear coat • Protective floor caps 	52" X 33" X 18.25"	Cubic Ft: 26 Ship Weight: 85	1064	1080	1096
QS Freight Class: 250						

5927MET Sofa Table



- Demilune 3/8" thick clear glass top
- Tapered-leg 16 gauge steel base
- Brushed aluminum powdercoat finish with a urethane clear coat
- Protective floor caps

QS Freight Class: 250

5923_ Round Table with Laminate Top and Metal Base



- Round 3/4" thick thermally fused laminate top
- Tapered-leg steel base
- Brushed aluminum powdercoat finish with a urethane clear coat
- Quick Ship finish options: Natural Maple, Windsor Cherry, Black and Mahogany
- Protective floor caps

QS Freight Class: 250

5920_ Coffee Table with Laminate Top and Metal Base



- Oval 3/4" thick thermally fused laminate top
- Tapered-leg steel base
- Brushed aluminum powdercoat finish with a urethane clear coat
- Quick Ship finish options: Natural Maple, Windsor Cherry, Black and Mahogany
- Protective floor caps

QS Freight Class: 250

5927_ Sofa Table with Laminate Top and Metal base

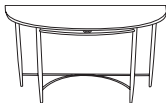

- Demilune 3/4" thick thermally fused laminate top
- Tapered-leg steel base
- Brushed aluminum powdercoat finish with a urethane clear coat
- Quick Ship finish options: Natural Maple, Windsor Cherry, Black and Mahogany
- Protective floor caps

QS Freight Class: 250

Trados Metal

5723MET End Table, Metal Base and Glass Top

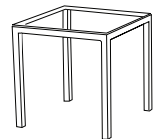

- .375" clear glass top
- 1.5" square tubular steel frame
- 1.5" x .5" tubular steel apron top support
- Brushed aluminum powdercoat finish with a urethane clear coat
- Aluminum finish coordinates with Trados Metal seating
- Protective floor caps

QS Freight Class: 250

5720MET Coffee Table, Metal Base and Glass Top

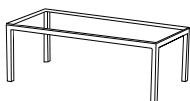

- .375" clear glass top
- 1.5" square tubular steel frame
- 1.5" x .5" tubular steel apron top support
- Brushed aluminum powdercoat finish with a urethane clear coat
- Aluminum finish coordinates with Trados Metal seating
- Protective floor caps

QS Freight Class: 250

			Zone Pricing	1	2	3
54" X 20.5" X 29"	Cubic Ft: 27	Ship Weight: 64		1206	1224	1242
28" X 28" X 24"	Cubic Ft: 16	Ship Weight: 36		1009	1024	1039
Finish Options: Natural Maple (FM), Windsor Cherry (WC), Mahogany (MAH), Graphite (GP), Black (BLK), Espresso (ESP), Boardwalk (BW), Driftwood (DW) and Shoreline (SL)						
52" X 33" X 18.25"	Cubic Ft: 27	Ship Weight: 62		1551	1574	1598
Finish Options: Natural Maple (FM), Windsor Cherry (WC), Mahogany (MAH), Graphite (GP), Black (BLK), Espresso (ESP), Boardwalk (BW), Driftwood (DW) and Shoreline (SL)						
54" X 19" X 29"	Cubic Ft: 27	Ship Weight: 47		1400	1421	1442
Finish Options: Natural Maple (FM), Windsor Cherry (WC), Mahogany (MAH), Graphite (GP), Black (BLK), Espresso (ESP), Boardwalk (BW), Driftwood (DW) and Shoreline (SL)						
25.5" X 25.5" X 25"	Cubic Ft: 16	Ship Weight: 50		835	848	860
49.5" X 25.5" X 19"	Cubic Ft: 25	Ship Weight: 76		1089	1105	1122

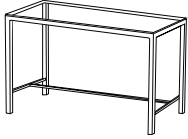
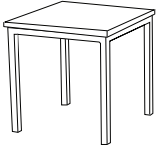
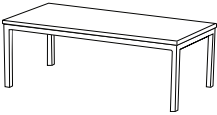
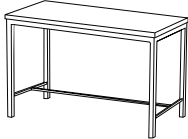
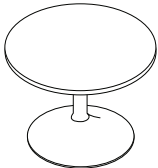
		Zone Pricing		1	2	3						
5727MET Sofa Table, Metal Base and Glass Top		55.5" X 19.5" X 31" Cubic Ft: 26	Ship Weight: 77	1234	1253	1271						
	<ul style="list-style-type: none"> • .375" clear glass top • 1.5" square tubular steel frame • 1.5" x .5" tubular steel apron top support • Brushed aluminum powdercoat finish with a urethane clear coat • Aluminum finish coordinates with Trados Metal seating • Protective floor caps 											
QS	Freight Class: 250											
5723 End Table, Metal Base and Laminate Top		25.5" X 25.5" X 25" Cubic Ft: 16	Ship Weight: 46	835	848	860						
	<ul style="list-style-type: none"> • 1" thick themally fused laminate top • 1.5" square tubular steel frame • 1.5" x .5" tubular steel apron top support • Brushed aluminum powdercoat finish with a urethane clear coat • Aluminum finish coordinates with Trados Metal seating • Protective floor caps 	Finish Options: Black (BLK), Boardwalk (BW), Driftwood (DW), Espresso (ESP), Graphite (GP), Mahogany (MAH), Natural Maple (FM), Shoreline (SL) and Windsor Cherry (WC) Quick Ship Finishes: Black (BLK) and Natural Maple (FM)										
	Freight Class: 250	<table border="1"> <thead> <tr> <th>OPTION</th> <th>PRICE</th> <th>CODE</th> </tr> </thead> <tbody> <tr> <td>Glass Top Overlay</td> <td></td> <td>5723TOP</td> </tr> </tbody> </table>					OPTION	PRICE	CODE	Glass Top Overlay		5723TOP
OPTION	PRICE	CODE										
Glass Top Overlay		5723TOP										
QS												
5720 Coffee Table with Laminate Top and Metal Base		49.5" X 25.5" X 19" Cubic Ft: 26	Ship Weight: 68	1089	1105	1122						
	<ul style="list-style-type: none"> • 1" thick themally fused laminate top • 1.5" square tubular steel frame • 1.5" x .5" tubular steel apron top support • Brushed aluminum powdercoat finish with a urethane clear coat • Aluminum finish coordinates with Trados Metal seating • Protective floor caps 	Finish Options: Black (BLK), Boardwalk (BW), Driftwood (DW), Espresso (ESP), Graphite (GP), Mahogany (MAH), Natural Maple (FM), Shoreline (SL) and Windsor Cherry (WC) Quick Ship Finishes: Black (BLK) and Natural Maple (FM)										
	Freight Class: 250											
QS												
5727 Sofa Table with Laminate Top and Metal base		55.5" X 19.5" X 31" Cubic Ft: 26	Ship Weight: 71	1234	1253	1271						
	<ul style="list-style-type: none"> • 1" thick themally fused laminate top • 1.5" square tubular steel frame • 1.5" x .5" tubular steel apron top support • Brushed aluminum powdercoat finish with a urethane clear coat • Aluminum finish coordinates with Trados Metal seating • Protective floor caps 	Finish Options: Black (BLK), Boardwalk (BW), Driftwood (DW), Espresso (ESP), Graphite (GP), Mahogany (MAH), Natural Maple (FM), Shoreline (SL) and Windsor Cherry (WC) Quick Ship Finishes: Black (BLK) and Natural Maple (FM)										
	Freight Class: 250											
QS												
Eve												
5828 Round End Table - Laminate Top and Trumpet Base		28" X 28" X 20.25" Cubic Ft: 15.4	Ship Weight: 62	899	912	926						
	<ul style="list-style-type: none"> • 3/4" thick thermally fused laminate top is 28" in diameter • Brushed aluminum trumpet style base • Ships fully assembled 	Finish Options: Black (BLK), Boardwalk (BW), Driftwood (DW), Espresso (ESP), Graphite (GP), Mahogany (MAH), Natural Maple (FM), Shoreline (SL) and Windsor Cherry (WC) Quick Ship Finishes: Black (BLK), Natural Maple (FM), Windsor Cherry (WC) and Mahogany (MAH)										
	Freight Class: 150											
QS												

6700 Series

Zone Pricing	1	2	3
--------------	---	---	---

6720 Cocktail Table, Wood Veneer Top

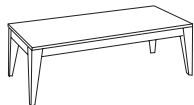

- Solid hardwood legs
- Veneer top
- Available in all seating finishes
- Assembly required

54" X 24" X 16"	Cubic Ft: 5	Ship Weight: 55	1187	1205	1223
-----------------	-------------	-----------------	-------------	-------------	-------------

QS Freight Class: 85

6730 Cocktail Table, Laminate Top

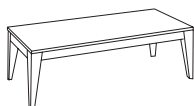

- Solid hardwood legs
- TFL top with AdvantEdge banding
- Available in all Hyperwork finishes
- Assembly required

54" X 24" X 16"	Cubic Ft: 5	Ship Weight: 65	1175	1193	1210
-----------------	-------------	-----------------	-------------	-------------	-------------

QS Finish Options: Natural Maple (FM) and Windsor Cherry

QS Freight Class: 85

6723 End Table, Wood Veneer Top

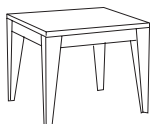

- Solid hardwood legs
- Veneer top
- Available in all seating finishes,
- Assembly required

24" X 28" X 20"	Cubic Ft: 3	Ship Weight: 40	882	895	908
-----------------	-------------	-----------------	------------	------------	------------

QS Freight Class: 85

6733 End Table, Laminate Top

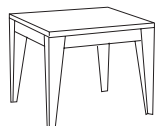

- Solid hardwood legs
- TFL top with AdvantEdge banding
- Available in all Hyperwork finishes
- Assembly required

24" X 28" X 20"	Cubic Ft: 3	Ship Weight: 40	871	884	897
-----------------	-------------	-----------------	------------	------------	------------

QS Finish Options: Natural Maple (FM) and Windsor Cherry

QS Freight Class: 85

Hyperwork

HW_CT48 Coffee Table

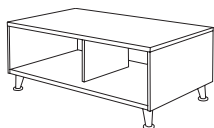

- Open storage/display shelf and top
- Angled satin finish chrome legs with stationary feet to match Claudia Series
- Ships fully assembled

48" X 24" X 18"	Cubic Ft: 11.9	Ship Weight: 96	781	793	804
-----------------	----------------	-----------------	------------	------------	------------

Finish Options: Black (E), Boardwalk (BW), Driftwood (DW), Espresso (X), Graphite (GP), Mahogany (M), Natural Maple (FM), Shoreline (SL) and Windsor Cherry (WC)

Freight Class: 150

HW_ET18 End Table

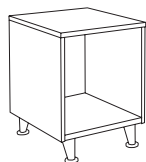

- Open storage/display shelf and top
- Angled satin finish chrome legs with stationary feet to match Claudia Series
- Ships fully assembled

18" X 22" X 24"	Cubic Ft: 6.9	Ship Weight: 50	608	617	626
-----------------	---------------	-----------------	------------	------------	------------

Finish Options: Black (E), Boardwalk (BW), Driftwood (DW), Espresso (X), Graphite (GP), Mahogany (M), Natural Maple (FM), Shoreline (SL) and Windsor Cherry (WC)

Freight Class: 150

OCCASIONAL TABLES SIN 711-11

OCCASIONAL TABLES

HW_ET23 End Table

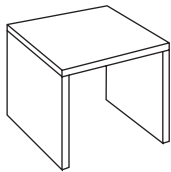

- Multiple uses
- Quick Ship in Windsor Cherry
- Assembly required

	Zone Pricing	1	2	3
22" X 24" X 18" Cubic Ft: 2.1 Ship Weight: 30		341	346	351
Finish Options: Black (E), Boardwalk (BW), Driftwood (DW), Espresso (X), Graphite (GP), Mahogany (M), Natural Maple (FM), Shoreline (SL) and Windsor Cherry (WC)				

QS Freight Class: 85

HW_CT20 Coffee Table

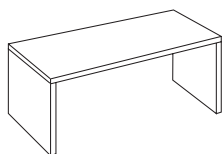

- Multiple uses
- Quick Ship in Windsor Cherry
- Assembly required

48" X 24" X 15" Cubic Ft: 3.6 Ship Weight: 50		408	414	420
Finish Options: Black (E), Boardwalk (BW), Driftwood (DW), Espresso (X), Graphite (GP), Mahogany (M), Natural Maple (FM), Shoreline (SL) and Windsor Cherry (WC)				

QS Freight Class: 85

9100 Series

9120 Cocktail Table



- Wood veneer top
- Solid hardwood legs
- Ships fully assembled

54" X 24" X 16.5" Cubic Ft: 16 Ship Weight: 65		1149	1166	1183
Finish Options: Available in all seating finishes				

QS Freight Class: 150

9123 End Table

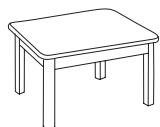

- Wood veneer top
- Solid hardwood legs
- Ships fully assembled

24" X 28" X 20.25" Cubic Ft: 9 Ship Weight: 40		826	838	851
Finish Options: Available in all seating finishes				

QS Freight Class: 150

Marquet

VT_100 End Table

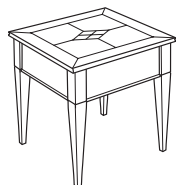

- Marquetry design
- Cherry, Maple and Walnut veneers cut and spliced in unique pattern
- Full-fill, catalyzed lacquer finish
- Concave edge profile on 3/4" thick top
- Fluted legs
- Some assembly required

21.75" X 21.75" X 20.75" Cubic Ft: 3.5 Ship Weight: 29		1040	1056	1071
Finish Options: Honey Cherry (H) or Rouge Mahogany (M)				

Freight Class: 125

VT_110 Coffee Table

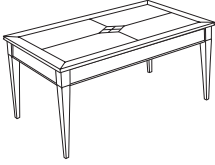

Freight Class: 125

- Marquetry design
- Cherry, Maple and Walnut veneers cut and spliced in unique pattern
- Full-fill, catalyzed lacquer finish
- Concave edge profile on 3/4" thick top
- Fluted legs
- Some assembly required

	Zone Pricing	1	2	3
47.25" X 27" X 20.75"	Cubic Ft: 7.6 Ship Weight: 50	1364	1384	1405

Finish Options: Honey Cherry (H) or Rouge Mahogany (M)

VT_120 Console/Sofa Table

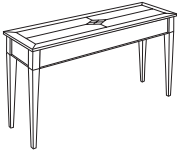

Freight Class: 125

- Marquetry design
- Cherry, Maple and Walnut veneers cut and spliced in unique pattern
- Full-fill, catalyzed lacquer finish
- Concave edge profile on 3/4" thick top
- Fluted legs
- Some assembly required

58.75" X 17.25" X 29.25"	Cubic Ft: 8.3 Ship Weight: 54	1562	1585	1609
--------------------------	-------------------------------	-------------	-------------	-------------

Finish Options: Honey Cherry (H) or Rouge Mahogany (M)

Bedford

TR_4020 Traditional Cocktail Table

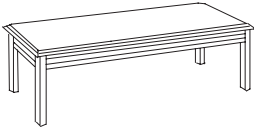

Freight Class: 100

- High-gloss, high pressure laminate top in Mahogany and Windsor Cherry
- Shaped edges
- Ships unassembled, easy assembly

54" X 24" X 16"	Cubic Ft: 5.5 Ship Weight: 69.5	833	845	858
-----------------	---------------------------------	------------	------------	------------

Finish Options: Mahogany (M) and Windsor Cherry (WC)

TR_4023 Traditional End Table

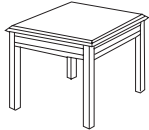

Freight Class: 92.5

- High-gloss, high pressure laminate top in Mahogany and Windsor Cherry
- Shaped edges
- Ships unassembled, easy assembly

22" X 27" X 18"	Cubic Ft: 2.5 Ship Weight: 38	689	699	710
-----------------	-------------------------------	------------	------------	------------

Finish Options: Mahogany (M) and Windsor Cherry (WC)

FEDERAL EXPRESS GROUND

ITEMS BELOW CAN BE SHIPPED VIA FEDERAL EXPRESS GROUND SERVICE:

Casegood Accessories

MODEL	DESCRIPTION
TL2P	Task Light
MDCPU	CPU Holder
MDE	Power Strip
MDWM	Wire Management Channel
MD100-MD1014	Accessories for Accessory Wall
MDSHELF 18-36	Shelf for Accessory Wall
PNP	Plug-N-Play
H26	Seat Cushion for Under Surface Storage

Keyboard Trays

MODEL	DESCRIPTION
PKP25_	Keyboard Platform
PKP35_	Keyboard Platform
PKMP36_	Keyboard Platform
AKT008	Articulating Keyboard Tray (any mechanism)
AKT007	Articulating Keyboard Tray (any mechanism)
HW_K21	Keyboard Platform
HW_K25	Keyboard Platform
HW_K29	Keyboard Platform
TR_3096	Keyboard Platform

Center Drawers

MODEL	DESCRIPTION
HWCD_19,25,32,38	Center Drawer
TR_29/30/32	Center Drawer
V_22,24,28,29/32/34/38	Center Drawer
WY_18,19,32,28	Center Drawer

Office Seating

MODEL	DESCRIPTION
500 (Not Assembled)	Task Chair
580	Task Chair
580CB	Task Chair
581	Task Chair
581CB	Task Chair
582	Task Chair
751 (Not Assembled)	Executive Swivel
752 (Not Assembled)	Management Swivel
757	Nesting Chair
757B	Nesting Chair
759 (Not Assembled)	Guest Chair
2013	Guest Chair
2016	Conference Chair
1093	Arm Chair
723 or 724 (Up to one carton of four)	Stax Chair
720-GC	Seat Connector

Occasional Tables

MODEL	DESCRIPTION
TR_4023	End Table
VT_100	End Table
VT_110	Coffee Table
HW_ET23	End Table
6723	End Table
T1005	Connecting Table

Reception/Team Seating

MODEL	DESCRIPTION
CH	Cup Holder
DH	Document Holder for Team Chair
NH	Newspaper Holder for Team Chair
58B	Ganging Bracket

LIMIT OF ONE ITEM WILL SHIP FEDERAL EXPRESS GROUND SERVICE.
MORE THAN ONE OF THESE ITEMS ON ONE ORDER WILL SHIP BY TRUCK

The image displays a stack of approximately ten different fabric samples, likely for seating upholstery. The fabrics vary in texture, color, and weave. From top to bottom, the samples include: a dark grey fabric with a fine, regular grid pattern; a medium grey fabric with a similar grid pattern; a light grey fabric with a slightly more pronounced grid; a white fabric with a very fine, almost invisible grid; a medium grey fabric with a distinct, larger-scale grid; a dark grey fabric with a fine grid; a medium grey fabric with a fine grid; a dark grey fabric with a fine grid; a dark grey fabric with a prominent, larger-scale grid; and a dark grey fabric with a fine grid. The fabrics are stacked and slightly offset, creating a sense of depth and showcasing the variety of options available.

SEATING UPHOLSTERIES AND TECHNICAL SPECIFICATIONS

- Available on all HPFi Seating
- All available at HPFi industry-leading standard lead times

Due to the natural characteristics of leather, finished furnishings may vary from original swatches. HPFi neither guarantees nor warrants leather for color, color consistency, grain or other characteristics. We cannot accept return of leather furnishings for such issues.

Real. When you specify leather furnishings from HPFi, each piece is 100% leather. All are real, top-grain leathers. No synthetics. No substitutes. Just real leather selected for quality and characteristics that create unique furnishings.

Natural. Leather is a natural material. It is an environmentally conscious upholstery cover salvaged as a by-product from meat production processes. Incorporating leather into multiple products – from furniture to clothes – is consistent with "green" efforts to improve production's impact on our environment.

Leather. Leather is **UNIQUE**. Each hide features characteristics developed in nature, distinguishing it from any other hide. Even within a leather hide, variations in color, texture and markings (scars, scratches, wrinkles, etc.) are natural and will appear within a given upholstered piece of furniture. These variations are not imperfections, rather they are the very essence of what makes leather an exquisite and preferred upholstery material.

LEATHER ADVANTAGES. History and tradition of use generate a special affinity and emotional preference for leather. Also consider:

- Leather breathes. It can absorb up to 25% of its own weight in humidity and release that humidity, so the body does not perspire on leather as it does on vinyl.

- Leather adapts to the closest temperature. An untouched leather chair remains room temperature. Once you sit down, the leather reaches body temperature, no higher!
- Leather is less permeable than fabrics. This barrier feature protects internal chair components from spills, inhibits dust collection by a chair's cushioning material and provides easily cleanable surfaces.

Top Grain. All are top-grain leather taken from the outermost layer of the hide, providing the strongest, softest and most breathable leather from the hide. Additionally, top grains show the natural markings (wrinkles, scratches, scars, etc.) that make each leather unique.

THE LANGUAGE OF LEATHER

Leather hides are processed in many different fashions, creating a variety of appearances, tactile qualities and performance capabilities. These processes and the resulting characteristics create a leather language used to classify leathers as outlined below.

Full vs. Corrected Grain. Full grain leathers exhibit more of the natural variation, texture and markings of the animal. These leathers are generally softer than corrected leathers. Corrected grain leathers have been mechanically altered through buffing, sanding or embossing to create more consistent grain pattern and uniform appearance.

Semi-Aniline. Starting with the same base as full anilines, the semi-aniline is a soft leather featuring a transparent finish that improves light and stain resistance. Slight pigmentation may be added to minimize color variation within the hide.

Pigmented. These leathers feature pigment dye applied by machine spray or roller coating, then followed by a finish coat to seal the pigment. Pigment/sealer increases a leather's resistance to fading and wearing while decreasing the softness of the material. Pigmented leathers are easier to clean and care for than non-pigmented leathers.

Pullup. Pullup leathers derive their color from waxes or oils, which dissipate and become lighter in color when the leather is pulled, as done during the upholstery process. This creates worn, weathered, distressed appearance typically found only on furnishings subjected to years of use.

Hand Antiqued. As the name implies, these leathers are handcrafted using traditional leather techniques.

Sauvage. Subtle, abstract two-tone finishes on leather provide visual depth and interest to a leather and are known as Sauvage.

HPFi can work with our leather supplier partners to color match an existing leather installation. There is a minimum of 500 square feet. Lead time to color match will take 5 - 6 weeks.

Note: HPFi leather seating employs multi-piece backs and sides to improve yield of natural leather hides.

Care & Cleaning
Leather specialists at Leather Master can provide you with specially-developed leather care and cleaning agents.
Call 888-825-6551.



GRADE L

Baroque

AL03.....	Black
AL04.....	QS Blackberry
AL05.....	QS Midnight
AL06.....	Hunter
AL07.....	Spruce

Crackle

AL12.....	Chianti
AL13.....	Coffee
AL14.....	Walnut

Mammut

AL18.....	QS Black
AL15.....	Parchment
AL20.....	Burgundy
AL16.....	Hunter Green
AL19.....	Navy
AL17.....	Fawn
AL22.....	Tan
AL23.....	Espresso

Classico

Black
Chocolate
Henna
Wine

GRADE LL

Kingsland

AL21.....	Coffee
AL24.....	Navy
AL27.....	Chaps
AL29.....	Jalapeno

FOC Earth

560001.....	Black
560007.....	Tobacco
560029.....	Parchment
560032.....	Chocolate
560035.....	Fawn

Lena

2500.....	Pewter
3338.....	Navy
3364.....	Sequoia
3368.....	Chateau
3396.....	Linen
5454.....	Celtic
8000.....	White
9000.....	Black

Hide	Number of Colors	100% Top Grain	Full Grain	Semi-Aniline	Pigmented	Machine Spray	Sauvage	Chrome-Free
Baroque	5	•		•	•	•	•	
Crackle	3	•		•	•	•	•	
Mammut	8	•		•	•	•		•
Kingsland	4	•		•	•	•	•	
FOC Earth	31	•		•	•	•		•
Lena	48	•	•	•	•	•		

All HPFi seating products are available in the following upholsteries from these mills/distributors. Patterns have been graded in to simplify quoting/ordering as well as save time versus the Customer's Own Material processes. Please visit the suppliers' web sites or www.HPfi.com for the most up to date list as materials may vary throughout the year.

ABSECON

PATTERN	Grade
Rhumba	2

CULP CONTRACT

PATTERN	Grade
Archetype	2
Cantina Recycled Leather	3
Castillo Faux Leather	3
Dorset	1
Dillon Faux Leather	1
Dot Com Faux Leather	3
Fandango	2
Fine Tune	2
Gunslinger Recycled Leather	3
Hathaway Vinyl	3
Morticia	2
Ridgecrest	2
Venue	3
Winslow	2
Yosemite Faux Leather	1

KB CONTRACT

PATTERN	Grade
Connect	1
Colorado	2

GUILFORD OF MAINE

PATTERN	Grade
Royalty	1
Sway	1

SPRADLING

PATTERN	Grade
Invision	4
Nuance	4
Reflex	4
Sequins	4
Silvertex	4
Whisper	4

ULTRAFABRICS

PATTERN	Grade
Brisa	9
Brisa Distressed	9
Primera	7
Promessa	9
Ultraleather	9
Ultraleather Pro	9

VALDESE WEAVERS

PATTERN	Grade
Pavers	3
Soothe	3

Please note, patterns in **bold type** are part of HPFi's **NOW** Quick Ship program. See page 3 for details.

All HPFi seating products are available in Mayer Fabrics' upholsteries. Patterns have been graded in to simplify quoting/ordering as well as to save time versus Customer's Own Material processes. Contact Customer Service with HPFi models, quantities and selected Mayer Fabrics' patterns. Patterns not listed must be priced per project. Visit www.HPfi.com or www.mayerfabrics.com for the most up to date list as materials may vary throughout the year.

MAYER FABRICS

FABRIC	Grade						
PATTERN							
Align	4	Honeycomb	4	Source plus DuraBlock™	8	Panache	12
Array	8	Hoopla	6	Spacer Mesh	4	Paparazzi	11
Artistry	4	Hopsack	8	Spokes	11	Pastime	8
Ascension	11	In The Groove	7	Stop & Go	9	Positive Thoughts	11
Aurora	11	Infinity	10	Suna	12	Primo	7
Avenue	9	Intrigue	5	Sutra	11	Rain Dance	7
Banner	4	Jenga	7	Synapse	11	Ratio	11
Batik	4	Jubilee	4	Theory	7	Razzmatazz	10
Beckon	3	Juncture	13	Turnabout	10	Realm	11
Botanica	8	Karma	10	Twister	7	Replay	9
Boteh	14	Katagami	12	Valet	4	Reveal	7
Bungalow	10	Kismet	9	Variant	4	Round 'N Round	11
Burst	7	Locomotion	6	Venetian	18	Smart Suede	7
Camelot	6	Lotus	12	Venue	6	Social Network	7
Canvas	9	Madras	6	Vibrant	7	Suede	7
Cavalier	4	Mandala	14	Vintage Mohair	20	Time Line	7
Charade	10	Marquise	4	Vipassana	11	Viewpoint	10
Circuit	10	Marvel	9	Vogue	6	Whimsy	12
Circumference	10	Matrix	11	Volante	18	Xanadu	10
Collage	12	Maze	9	Whirligig	12		
Component	6	Meander	5	Wildflower	11		
Continuum	4	Metal Strips	11	Wilson	11		
Cross Check	1	Monogram	6	Wool Boucle	13	VINYL	
Dapper	4	Moonscape	5	Zazen	11	PATTERN	Grade
Daydream	7	Mosaic	5			All Seasons FR	4
Dazzle	8	Mosaic plus DuraBlock™	8			Apex	5
Destiny	3	Motif	8	WOVEN CRYPTON		Atomic	5
Destiny plus DuraBlock™	8	Myriad	9	PATTERN	Grade	Blocks	4
Detail	8	Mystic	6	Acclaim	7	Catwalk	6
Duraweave® 10	3	Nuance	8	Amadeus	10	Chaps FR	6
Echo	7	Nylon-Stat ESD	10	Arabesque	7	Charette	6
Ecosphere	8	Obi	11	Aristocrat	7	Cirque	6
Eleanor Rigby	9	Optic	4	Big Top	6	Contempo FR	5
Element	5	Orbit	6	Celtic	11	Crystals	8
Encore	9	Origami	6	Cosmopolitan	7	Curlicue	6
Equation	6	Ottoman	9	Cuddle Up	4	Dakota	6
Equinox	7	Patio	4	Debonair	5	Dande	6
Erode	12	Pinnacle	5	Debut	8	Dublin Tweed FR	6
Esprit	7	Plaza	7	Disco	12	Entwine	6
Essex	6	Portal	8	Entourage	7	Essence	6
Europa	7	Prism	4	Escapade	11	Finesse	5
Evolve	11	Quattro	1	Fairy Tales	9	Gala	7
Facets	10	Reflector	11	FanFare	12	Guardian	6
Fedora	3	Rejuvenate	11	Fathom	8	Images	6
Figure Eight	4	Reverb	5	Finale	7	Interlace	6
Flock	13	Rhythm	10	Habitat	7	Interlochen	4
Flower Power	5	Rock & Roll	10	Holiday	10	Key Largo	4
Focal Point	5	Sakura	13	Jitterbug	11	Linen	4
Forte	1	Samarai	11	Journey	7	Links	6
Foundation 10	2	Sequel	4	Lavish	7	Madrid Sp Black	2
Geisha	13	Sequel plus DuraBlock™	6	Malibu	7	Matka	6
Genesis	6	Shantung	5	Metro	7	Microdot	6
Genesis plus DuraBlock™	8	Sherlock	4	New Dimensions	6	Mingle	7
Groundwork	8	Shibori	11	Nirvana	10	Oxen SP Black	2
Haberdash	5	Signs	13	Nostalgia	7	Peerless	6
Hole In One	9	Soleil	11	Obsession	12	Pinehurst	6
		Sophisticate	6	On The Spot	11	Prado	6
		Source	6			Punch	5

(10) - 10 year warranty. See sample card for details.

Please note, patterns in **bold type** are part of HPFi's **NOW** Quick Ship program. See page 3 for details.

MAYER FABRICS: (CONTINUED)

VINYL (continued)		FAUX LEATHER		FAUX LEATHER (continued)	
PATTERN	Grade	PATTERN	Grade	PATTERN	Grade
Sequence	5	Antique	6	Laredo	8
Sierra SP Black	2	Berkshire	7	Longhorn	7
Silk Screen	6	Bolero	7	Makore	8
Silverweave	4	Caressa	5	Maverick	4
Skate	8	Caressa Seuede	6	Melody	8
Sketch	6	Cascade	7	Milano	6
Slick	6	Cayman	8	Niche	8
Spirograph	8	Cork	8	Outback	5
Toss Up	6	Counterpoint	7	Palermo	7
Tributary	6	Durango	4	Patent	8
Tussah	6	Emu	4	Ranchero	2
Uptown	6	Florentino	4	Rift	7
Vinyl Stat ESD	8	Glimmer	8	Shimmer	8
Wallaby SP Black	2	Hombre	8	Splendor	8
Willow	5	Jekyll & Hyde	6	Verona	5
		Kobe	4		

All HPFi seating products are available in C.F. Stinson fabrics. Patterns have been graded in to simplify quoting/ordering as well as save time versus Customer's Own Material processes. Contact Customer Service with HPFi models, quantities and selected C.F. Stinson patterns. Patterns not listed must be priced per project. Visit www.HPFi.com or www.cfstinson.com for the most up to date list as materials may vary throughout the year.

CF STINSON

PERFORMANCE/CRYPTON					
PATTERN	Grade				
Acadia Epingle'	16	Blip	5	Comeback	12
Ace	5	Block Party	11	Concentric	10
Acanthus	15	Bloom	15	Continuum	7
Acrobat	12	Bongo	11	Cottonwood	9
Adirondack	10	Breton	10	Courtyard	11
Aero	9	Brilliant	5	Cozy	9
Alchemy	9	Bryant Park	4	Cranbrook Loop	20
Alfresco	10	Calibration	11	Cruisin'	12
Algiers	13	Calla	11	Crypton Metro	7
Alignment	9	Cannon Beach	13	Crypton Suede	7
Aloha	11	Catalina	11	Crystalline	11
Arc	7	Catwalk	9	Current	12
Balance Beam	11	Celeste	10	Curves Ahead	11
Bali	11	Chakra	13	Cyma	13
Bass Line	10	Chauncey	7	Daddy-O with Agion	13
Beatbox	10	Chi with Agion	13	Dart	5
Beep Beep	11	Chloe	9	Deflection	10
Bespoke	7	Cinnamon Blossom	12	Detail	12
		Cirro	10	Deza	13
		Coco	10	Diffusion	14
		Colden	11	Double Time with Agion	13
				Duet	9
				Elderberry	12
				Equinox	8
				Fast Lane	5
				Fenestra	12
				Fignit	10
				Firefly	12
				Flex	8
				Flight	12
				Flip Flops	11
				Florentine	8
				Folio	11
				Fractal	11
				Freehand	7
				Furrows	6
				Geodesic	11
				Gradation	7
				Gravity	8
				Grove	11
				Hands On	10
				Happy Hour	7

Please note, patterns in **bold type** are part of HPFI's **NOW** Quick Ship program. See page 3 for details.

CF STINSON (continued)

PERFORMANCE/CRYPTON

PATTERN	Grade
Happy Tappy	12
Haven	9
Helix	11
Hi-Fi	5
Highlight	5
Hive	5
Horizons	12
Hot Spot	9
Hourglass	11
Hudson	13
Hush	10
I Spy	10
Impression	12
Inside Track	6
Interval	8
Isabella	11
Jala	15
Jam Session with Agion	13
Jambi Stripe	10
Jasmine Screen	10
Jump with Agion	13
Kambala	13
Kennebunk	11
Ketana	13
Kinetic	9
Knock Knock	12
Labyrinth	11
Leaps & Bounds	10
Lift	12
Line Dance	8
Linus	9
Lucent	14
Makeover	12
Mali	11
Manchester	8
Marimba	9
Marquetry	10
Mingle	10
Monhegan	10
Montage	8
Mumbai	14
Nest	11
New Hempstead	4
Next Scene	10
Nimble	9
Nova	7
Now & Zen with Agion	13
On the Money	8
Oscillate	12
Outlander	6
Pacifica	12
Panorama	12
Park Avenue	10
Peninsula Mohair	18
Perimeter	7
Persuasion	8
Pinball	9
Pivot	5
Polka	5
Portico	8
Posh	8
Profile	9
Queue	10
Radiance	14
Raquette	10
Realm	8
Refraction	15
Respite	12
Retrograde	5
Revolution	9
Riddle	5
Salinas	14
San Simeon	13
Satellite	6
Scintillate	12
Seagrass	11
Sebago	10
Second Act	10
Sequence	5
Shift	5
Sideline	7
Skyline	12
Sleeping Bear Dunes	10
Snuggle	7
Spark	15
Spindles	13
Splash	10
Sprint	4
Squire	7
Stellar	6
Stipple	6
Straight and Narrow	10
Stratford	16
Sumatran Palm	11
Summit	9
Sunburst	11
Sunswept	11
Supersilliness	12
Swivel	11
Symmetry	11
Tessellate	13
Thicket	5
Torus	10
Tracing	7
Tranquility	10
Transcend	4
Tribeca	5
True Path with Agion	13
Tweed	10
Umbrian Rain	14
Up Tempo with Agion	13
Vanish	12
Vapor	12
Varati	14
Velocity	8
Vermont	11
Vibe	9
View	12
Vineyard	15
Vintage	11
Vision	5
Voltage	12
Whirl	11
Willow Talk	11
Wish	16
Zoom	8

VINYL & NON-PVC

PATTERN	Grade
Abacus	10
Affinity	11
Apex*Crypton Revi	7
Archetype	6
Arioso	10
Aspen	11
Atlas	4
Auberge	11
Avant	4
Bambu-EnVi	8
Banyan	11
Bari	11
Bistro	4
Bon Voyage	11
Bubblerrake	13
Budget Black	2
Burkshire	5
Camino	17
Capreni	11
Carlisle	5
Casablanca	11
Cassidy	5
Catalyst	4
Channel	5
Chroma	7
Cielo	17
Cirque	7
Citadel	4
Clean Slate	6
Colorguard	4
Connect	5
Core	4
Corium	10
Criss Cross	5
Dakota	6
Dash	7
Diva	6
Dodgeball	10
Effervescence	11
E'Lan-HC	17
Eli	11
English Pub	5
Entrada	11
Excursion	6
Expressions	5
Fizz	4
Frequency	7
Fuse	4
GeoMet	6
Glisten	17
Grand Sierra	4
Grille	6
Juxy	10
Kilkenny Tweed	5
Kusari	6
Laredo	4
Latitude	6
Lava	12
Martini	11
Matrix	7
Mesa	17
Mica	6
Moccasin	4
Modena	10
Montana	4
Moxie	9
Natural World	11
Naugaleather	5
Naugasoft	4
Neochrome III	4
Nishiki	6
Olympus	11
Orbit	5
Oxford	5
Patriot Plus II	4
Petals	9
Plexus	11
Prisma	11
Promenade	7
Raffia	7
Rainier	4
Rally	3
Revolve	13
Rialto	5
Ripple	13
Rivera	11
Rogue II	3
Scout	5
Script	7
Sedona	17
Sentry - HC	5
Shantung	5
Silverado with Agion	12
Simplicity	5
Sleek	6
Slightwave	11
Smile	10
Smoothie	5
Solitaire	6
Spirit Millenium	4
Stat-Con	9
Sterling with Agion	12
Stitch in Time	5
Strand	5
Sundance with StaKleen	9
Symphony Classic	5
Tender	16
Tendril	5
Tessuto	6
Valise	6
Vegas	4
Verdure - EnVi	8
Volterra - HC	17
Vortexia	13
Walk The Line	11
Waterwand	13
Whisper	4
Whitney	6
Wicker	11
Wink with Agion	12
Wyatt	8
Ybor	11
Ziggy	5
Zodiac	6

Please note, patterns in **bold type** are part of HPFi's **NOW** Quick Ship program. See page 3 for details.

All HPFi seating products are available in Momentum upholsteries. Patterns have been graded in to simplify quoting/ordering as well as save time versus Customer's Own Material processes. Contact Customer Service with HPFi models, quantities and selected Momentum patterns. Patterns not listed must be priced per project. Visit www.HPfi.com or www.momtex.com for the most up to date list as materials may vary throughout the year.

MOMENTUM

FABRIC	Grade	Insight	Grade	Span (InCase)	Grade	Torque	Grade
PATTERN		Interim	12	Starboard	11	Trefoil	9
Amuse	6	Intermix II	7	Strut	7	Upside	10
April	8	Jardin	11	Symbol	13	Viva II	9
Arrange	12	Jitney	9	Syntax	4	Waver	8
Audio	11	Juncture	12	Tactic	13	Zola	12
Audubon	12	Kindle	9	Tesla	11		
Avenue	6	Kinney	5	Tradition	3	COATED FABRIC	
Axis	3	Knack	4	Trove	12	PATTERN	Grade
Bandwidth II	10	Kudos	11	Turin	13	Acoustic	11
Bangle	2	Ledge	7	Twist	12	Agora II	6
Banter	12	Lella	12	Uplift	10	Beeline	4
Beep	6	Level	10	Vario	6	Bravo II	8
Bento	11	Lina	13	Veer	9	Canter	3
Bias	11	Lineup	4	Venue	6	Cashmere II	6
Bloc	12	Livia	13	Via	5	Cycle	8
Boom II	5	Lloyd	14	Vox	3	Echo II	11
Boxcar	11	Lore	12	Wander	11	Eon	4
Brisk	11	Lucio	17	Weaving Palettes	11	Foray	8
Buoy	11	Ludwig	14	Whim	11	Fringe	8
Cairns	13	Malmo	13			Groove	7
Camber	12	Mapping Ideas	14	CRYPTON		Hive	10
Carlo	14	Marcel	13	PATTERN	Grade	Icon	9
Centric	11	Marathon	3	Align	11	Kindred	10
Chipper	12	Medley	7	Almanac	12	Nifty	6
Cite	11	Millenium	3	Ardour II	11	Rein II	7
Clang	6	Mix	12	Ascend	8	Row	7
Core	1	Molto	13	Avanti	12	Sidestep	11
Course	11	Nagoya	13	Catalogue	12	Silica	9
Crossing Colors	14	Neon	11	Central	8	Silica Andy	15
Cryptic	11	Nimble	12	Channel	8	Silica Compass	15
Current	5	Odyssey	3	Docket	13	Silica Cusp	15
Dash	11	Ohs II	13	Domain	9	Silica Deflect	15
Dayspell	11	Origin	2	Effloresce	13	Silica Effloresce	15
Decode	4	Pace (InCase)	7	Elevate	13	Silica Etch	9
Delve	10	Painting Strokes	13	Elle	12	Silica Fiona	15
Dive	10	Panorama	12	Etude	13	Silica Fritz	15
Dividend	12	Parable	11	Evolve	12	Silica Hiatus	15
Drawing Lines	12	Parkside (InCase)	7	Flection	12	Silica Hoop	15
Drift	11	Perk	1	Hula	12	Silica Leather	9
Duo	11	Photon	11	Infusion	10	Silica Motive	15
Ebb	12	Pierre	14	Intermezzo	13	Silica Reach	15
Edison	11	Ping	7	Isla	8	Silica Roam	15
Embark	9	Pique	6	Jest	10	Silica Scout	15
Epic	3	Propensity II	5	Kayak	13	Silica Stride	15
Essay	12	Prospect	8	Keynote	7	Silica Tech	9
Estrella	12	Proximity	12	Mensa	11	Silica Waltz	15
Expo	1	Rally	11	Oath	8	Sublime II	5
Fleet	9	Refract	11	Pace (Crypton)	8	Tact II	11
Flow	11	Revolve	13	Parkside (Crypton)	9	Tetra	6
Flux	12	Riga	12	Phase	12	Velocity	7
Focal	6	Rivet	6	Recollection II	12		
Free	4	Sail	11	Redux	8		
Fuse	2	Scan	12	Roster	12		
Geo	13	Scrabble	6	Scribe	7		
Habit	5	Sidebar (InCase)	7	Sidebar (Crypton)	9		
Hearsay	11	Sketching Air	14	Span (Crypton)	8		
Helm	10	Skip	5	Spin	12		
Hue	4	Small Talk	11	Sway II	10		
Impact	6	Solace	6	Synergy	8		
Infinity	3	Solo2	8				
		Sort	11				

Please note, patterns in **bold type** are part of HPFi's **NOW** Quick Ship program. See page 3 for details.

- **NOW Quick Ship upholsteries can be applied to any HPFi Seating**
- **Products can be shipped in seven (7) to ten (10) business days if "NOW" specified on Purchase Order**
- **Orders for color combinations will ship at standard lead time**
- **Please visit www.HPfi.com for the most up to date list of NOW upholsteries as the selections may vary throughout the year**

GRADE 1

Connect Vinyl
 Core Polyester
 Crosscheck Polyester
 Dillon PVC-Free Faux Leather
 Dorset Polyester
 Expo Recycled Polyester
 Forte' Polyester
 Perk Polyester
 Quattro Polyester
 Yosemite PVC-Free Faux Leather

GRADE 2

Bangle Recycled Polyester
 Colorado Vinyl
 Foundation 10 Recycled Polyester
 Rhumba Repeve Polyester

GRADE 3

Axis Recycled Polyester
 Canter PVC-Free Polyurethane
 Destiny Polyester/Cotton Blend
 Dot Com PVC-Free Polyurethane
 Epic Recycled Polyester
 Fuse Recycled Polyester
 Hathaway Vinyl
 Infinity Repeve Polyester
 Marathon Repeve Polyester
 Millenium Repeve Polyester
 Odyssey Repeve Polyester
 Tradition Repeve Polyester

GRADE 4

Citadel Vinyl
 Decode Recycled Polyester
 Free Recycled Polyester
 Invision Vinyl
 Knack Polyester
 Laredo Vinyl
 Sequins Vinyl
 Silvertex Vinyl

GRADE 5

Caressa Faux Leather
 Carlise Vinyl
 Contempo Vinyl
 Cover Cloth Recycled Polyester
 Intersect Recycled Polyester
 Quirk Recycled Polyester
 Retrograde Polyester
 Riddle Polyester
 Sublime II PVC-Free Polyurethane
 Verona Vinyl

GRADE 6

Channel Vinyl
 Guardian Healthcare Vinyl
 Orbit Vinyl
 Outlander Polyester
 Satellite Recycled Polyester
 Stellar Recycled Polyester

GRADE 7

Isla Recycled Polyester /
 Crypton® Green
 Nova Recycled Polyester
 Raffia Vinyl
 Redux Recycled Polyester /
 Crypton® Green
 Scribe Recycled Polyester /
 Crypton® Green

GRADE 8

Big Top Polyester
 Debonair Polyester
 Detail Solution-Dyed Repeve
 Groundworks Solution-Dyed
 Nylon
 Motif Solution-Dyed Polyester
 Nuance Solution-Dyed Polyester

GRADE 9

Encore Solution-Dyed Polyester
 Fairy Tales Polyester
 Hot Spot Polyester
 Revolution Polyester
 Silica Silicone
 Promessa PVC-Free Faux Leather
 Ultraeather Pro PVC-Free Faux
 Leather

GRADE 10

Circuit Solution-Dyed Repeve
 Nylon
 Circumference Solution-Dyed
 Nylon
 Haven Polyester
 Juxy Vinyl

GRADE L

Classico Leather

- **QS Quick Ship upholsteries can be applied to any HPFi Seating**
- **Products can be shipped in three (3) to five (5) business days if "QS" specified on Purchase Order**
- **Orders for color combinations will ship at standard lead time**
- **Please visit www.hpfi.com for the most up to date list of QS upholsteries as the selections may vary throughout the year**

SOOTHE CRYPTON®

	COLOR	GRADE
Gold	03	3
Navy	16	3

PAVERS CRYPTON®

	COLOR	GRADE
Black Gold.....	09.....	3
Blue Water.....	31	3

FOUNDATION 10

	COLOR	GRADE
Apple Green..	350-023.....	2
Ebony	350-006	2
Parade Blue...	350-034	2

CORE

	COLOR	GRADE
Eve	950	1
Macro.....	952.....	1
Shale	953.....	1
Vital	954	1

EXPO

	COLOR	GRADE
Festive.....	964	1
Fog.....	965	1
Latte.....	963.....	1
Leaf	962.....	1
Lemon	966	1
Sprout.....	961.....	1
Sky.....	960	1

PERK

	COLOR	GRADE
Sesame	972.....	1
Walnut.....	970.....	1

QUATTRO

	COLOR	GRADE
Dark Orchid	300-005	1
Deep Crimson	300-001	1

SWAY

	COLOR	GRADE
Blue Sea	8454	1
Red River	4262	1
Sand Dollar.....	5506	1
Silver Fish.....	0621.....	1

COLORADO VINYL

	COLOR	GRADE
Bridle	CLR107	2
Black	CLR100.....	2

CONNECT VINYL

	COLOR	GRADE
Beet	CIR340.....	1
Black	CIR200.....	1
Mystic	CIR345.....	1

LEATHER

	COLOR	GRADE
Blackberry.....	AL04.....	L
Black	AL18.....	L
Hunter.....	AL06.....	L

FABRICS

HPFi strives to offer the best in appearance, durability, and value. Please refer to the seating warranty section on page 4 for more information. Most fabrics are ordered at the time we receive your order. Therefore no cancellations or changes are allowed once your order is entered and the fabrics are ordered. Please make certain that your clients know this when they are making their fabric selections.

Overview: Man-made fibers such as acrylic, olefin, polyester and nylon have achieved new levels of performance with current changes necessitating a true evaluation of each fabric on its own merit. Do not assume that a specific fabric is always the best. Consult the test results on the fabric specification sheet or sample card and evaluate its performance for your particular application. HPFi chooses only those fabrics that attain the upper portion of the durability spectrum.

VINYL

Overview: Vinyl coverings are normally 100% virgin PVC (Polyvinyl Chloride) supported by a man-made backing. They are sometimes textured and then surface finished or capped with a chemical film. Some vinyl upholstery fabrics are formulated to include silver ion particles, to provide an antibacterial and antimicrobial surface. Consult the technical information on the back of the vinyl swatch cards to choose the desired characteristics for the environmental setting in which the seating units will be used.

Protection: Periodic cleaning of the vinyl by washing with lukewarm water and a mild soap will prevent hardening, cracking and peeling due to body oils and body care products. Clean with wet sponge and dry with dampened cloth or sponge. Certain commercially available products clean routine spills effectively without causing the material to exude (lose) the softening agents which keep the vinyl soft and pliable. Improper cleaning products can break those softening agents and cause the vinyl to crack and peel.

FAUX LEATHER

Overview: Faux Leather is the term most commonly used for man-made polymers such as polyurethane or vinyl. It is a resilient, flexible and durable material that offers textures and a soft feel similar to that of leather. Like genuine leather, polyurethanes do offer some breathability (vapor transmission) whereas vinyl normally doesn't.

Protection: The greatest advantage of a faux leather over genuine cowhide leather is the cleanability and consistency of appearance.

LEATHER

Overview: Leather, by virtue of its natural inherent beauty, warmth and durability, creates aesthetic appeal for those individuals desiring the very finest in office seating. The exclusive use of top grain cowhides by HPFi in Grades L and LL, assures the customer of genuine leather as opposed to split or bonded leather substitutes.

The growth marks and healed scars which occur during the animals' lifetime give leather its distinguishing "character". These signatures will appear on the chair leather, assuring the customer of the use of authentic top grain hides. Genuine top grain leather mellows with age and gains a quality and value which is unlike any man-made substitute.

Full and Top Grain Leather vs. Split Leather:

When the hide is separated from the animal, it can be as much as 3/4" thick. A splitting machine then splits the hide into layers of desired thickness. Only the first cut is used on HPFi seating to insure maximum strength and beauty.

Protection: To remove spots and spills, wipe excess liquid up immediately with a clean absorbent cloth or sponge. If necessary, use clean lukewarm water only and let air dry naturally. If water is used, clean the entire area where the spot occurred. An example would be the entire seat cushion or entire arm. DO NOT dry wet areas with hair dryers, etc. For butter, oil or grease, wipe excess butter, oil or grease off the leather with a clean dry cloth, then leave it alone as the spot should dissipate into the leather in a short period of time. DO NOT apply water or try to wash such spots.

Please Note: These are recommended or suggested methods of cleaning. HPFi is not responsible for damage incurred while cleaning.

CLEANING CODES

Each upholstery utilized by HPFi has a cleaning code letter, assigned by the manufacturer for a specific pattern and is listed on the swatch card. The cleaning codes are as follows:

- W** - Water based cleaners recommended.
- S** - Solvent based cleaners recommended.
- WS** - Water or solvent based cleaners recommended.
- X** - Do not use any cleaning fluids.
- C** - 10% Bleach, 90% Water, rinse

To prevent overall soiling, frequent vacuuming or light brushing to remove dust and grime is recommended. Always pre-test a small inconspicuous area before proceeding to remove the stain.

UPHOLSTERY TESTING TERMS

Surface Abrasion: Abrasion resistance is the ability of a fabric to resist surface wear caused by flat rubbing contact with another fabric. There are two different methods commonly used to test abrasion, referred to as Wyzenbeek and Martindale. Most contract grade fabrics are tested using the Wyzenbeek method. Fabrics with abrasion results below 15,000 Wyzenbeek double rubs / 20,000 Martindale cycles may prove unsatisfactory in contract upholstery application. Abrasion results exceeding 100,000 double rubs / cycles are not meaningful in providing additional value in use. Higher abrasion resistance does not necessarily indicate a significant extension of the service life of the fabric. A fabric with double the number of abrasion cycles does not indicate double the service life. There is no correlation between different test methods. It is not possible to estimate the results that might be achieved on one test, by reviewing the results from another (e.g., Martindale & Wyzenbeek.) The following guide is a general rule of thumb for upholstery on HPFi furniture using the Wyzenbeek test method:

- Light Duty - 15,000 cycles (double rubs)
- Medium Duty - 35,000 cycles (double rubs)
- Heavy Duty - 50,000 plus cycles (double rubs)

For more information on surface abrasion, visit the web site for Association for Contract Textiles at www.contracttextiles.org.

Crocking: The degree of resistance of material to change color characteristics, or transfer its color to other materials in any environment during the life of the fabric.

Tear Strength: The force necessary to tear a fabric, usually expressed in pounds or in grams. The most commonly used method for determination of tear strength is the Elmendorf test procedure.

Tensile Strength: The actual number of pounds of resistance that a fabric will give to a breaking machine before the material is broken.

Fadometer/Color Fastness: The fadometer (light) test determines the resistance of a specific fabric color to prolonged exposure to sunlight utilizing a water-cooled xenon lamp fading apparatus for simulation. The color fastness test determines the degree of color retention and change in shade (or lack of) during the normal life of the fabric.

Fire Retardant: Fabrics treated with special chemical agents or finishes to make them retardant or resistant to burning. Fabrics may also achieve this property by using fibers with these properties built directly into the polymer. Fire retardant coatings or specifications vary according to code requirement. Please consult fabric specifications listed with each pattern in upholstery catalog for specific code acceptability. Upholstries offered or recommended by HPFi do not contain polybrominated diphenyl ethers (PBDE).

FLAMMABILITY & FIRE CODES

Treatment or finishing of fabrics is varied as many states and municipalities have developed their own criteria for fire retardant coverings. Although attempts have been made to offer a fabric which will pass as many of these codes as a group (e.g. Boston Fire Dept. Std., The Port Authority of N.Y. and N.J., and California Technical Bulletin 117), it may be necessary to specifically treat a fabric for a special code. If special treatment is required, or if treatment of a current fabric offered by HPFi to meet a certain code is required, please contact our Customer Service Department for quotation.

All upholstery offered by HPFi supplier partners meet California Technical Bulletin 117. The current version is California TB 117-2013. Any upholstery that meets this standard will also meet similar test methods ASTM, UFAC or NFPA260.

Consult specifications on our upholstery partners' web sites for pertinent fire code ratings and specifications. These specification sheets are also available from our Customer Service Department.

Please remember that a fire retardant fabric isn't fireproof or flameproof. The purpose of the retardant is to make fabrics flame resistant to a smoldering cigarette in order to provide time for egress.

California Technical Bulletin #133 requires heightened levels of flammability resistance and special testing. HPFi offers a range of seating products tested and certified to Cal 133. Contact HPFi Customer Service for more information.

HPFi offers a selection of reception and ergonomic seating that has been tested and certified by an independent laboratory to pass California Bureau of Home Furnishings and Thermal Insulation's Technical Bulletin #133 flammability requirements. These are the most stringent U.S. flammability requirements. Testing includes full-scale burn testing of a finished, upholstered chair, which is destroyed after a single test. HPFi has chosen to use a barrier cloth or fire-blocking layer between the foam cushioning and the external upholstery cover in order to comply with California Technical Bulletin 133.

All HPFi TB 133-certified chairs have been tested and certified in 100% recycled polyester fabrics from the Foundation 10 collection, which offers dozens of solid color crepe fabric options. These fabrics also pass 1,000,000 double rubs in surface abrasion testing (ASTM D 4157 Wyzenbeek Test).

Unless otherwise noted, any upholstered HPFi reception or ergonomic seating can be specified and manufactured to comply with California Technical Bulletin #133. The upcharge for each piece is determined by multiplying its fabric requirement (as stated in this price list) by \$66 list per yard.

Example: For a Claudia Club Chair #5301, you would add \$379.50 list (5.75 yards at \$66 list per yard) to the regular list price.

If laboratory certification is required for a specific style and upholstery combination, the following costs to the requesting party will apply:

- \$1,000 one-time fee for the testing and transportation of sample
- The cost of the test sample including appropriate upcharge as outlined above.

An additional 6 weeks will be added to the standard lead time for products requiring testing.

For additional information and California Technical Bulletin #133 pricing, please contact your HPFi Customer Service Representative.

COM (Customer's Own Material) / COL (Customer's Own Leather)

Upholstery material(s) furnished to HPFi by the customer requires special processing. Prior to HPFi accepting any COM orders, the COM/COL Order Form (see next page) must be submitted to HPFi for yardage requirements. Once this form is returned to you, you may accurately order your upholsteries for shipment to HPFi.

Any order received without the accompanying fabric will be entered and acknowledged with an open shipping date until fabric is received.

Inquiries should be sent to:

HPFi COM/COL Coordinator
1104 Bedford Street
High Point, NC 27263
(t) 800.447.3462
(f) 800.231.6784
(e) info@HPFi.com

A. COM/COL Shipping Address

All COM/COL fabrics and leather must be shipped prepaid:

HPFi COM/COL Coordinator
1104 Bedford Street
High Point, NC 27263

Make sure a copy of the COM/COL order form is attached to the upholstery (see form on following page). COD's are not accepted on customer's own material (COM) or customer's own leather (COL).

B. COM/COL General Information:

1. Do not fold any upholstery (textile, coated fabric, vinyl, polyurethane or leather) for shipment. All upholsteries must be rolled on a cardboard tube for shipment to HPFi. Folded fabric or leather may sustain permanent creasing, rendering it unsuitable for upholstering. HPFi will not apply creased goods to any upholstered item(s).

2. For specific yardage requirement, send the COM/COL order form request (see next page) to the HPFi Customer Service department. Seating model numbers, quantities and upholstery application orientation are required. A timely reply will be forwarded with yardage required.

3. COM orders are priced at Grade 2.
4. COL orders are priced at Grade 3.

C. COM/COL Warranty and Application of Upholsteries:

1. Upholsteries received from the supplier or customer for COM/COL applications are not covered by any warranties expressed or implied by HPFi including but not limited to wearability, light fastness or tailoring.

2. While we make every effort to check and cut COM material in the most appropriate manner, claims for flaws, insufficient yardage, discrepancies in the fabric, imperfections in the material, dye lot variations, or wearing quality of material furnished by the customer cannot be honored.

3. Do not estimate COM yardage from yardage in this Price Book. The yardage requirements shown in this Price Book are based on the use of non-directional upholstery, 54" wide applied in a "Topped" orientation.

4. Please fill COM/COL form completely including topped out or railroaded applications also add horizontal and vertical repeats.

D. COM/COL Shipping Dates:

If an acknowledged order contains both graded-in and COM/COL upholstered items on the same order, the order will be processed with an open ship date. Once the COM/COL upholstery is received, standard lead times will apply to the entire order.

E. COM/COL Combination Upholsteries

Many seating items may be selected with multiple upholstery covers on a single unit, such as vinyl arms and fabric seat/back or solid color fabric arms with a pattern seat/back. HPFi can accommodate these special requests as outlined below.

1. Indicate clearly on original order the combination of desired fabrics as follows:

- Chair Model
- Finish (if applicable)
- Seat fabric
- Back fabric
- Arm fabric

If seat and back will be same fabric, the order can list it as such.

2. Be certain to provide complete description of upholsteries, including pattern name, color name, and color number (if available).
3. Combinations are available on all graded-in upholsteries at standard lead time, not on QS or NOW Quick Ship programs. Combinations using COM upholsteries may require additional lead time and must follow the COM order process.



High Point, USA

COM/COL ORDER FORM

All information on this form is required to accurately calculate the COM yardage / COL sq. ft. needed

Please complete and send to the HPFi COM/COL Coordinator. Email: CustomersOwnMaterial@hpfi.com Fax: 800.231.6784

CUSTOMER INFORMATION

Account Number (if known) _____ Date _____

Dealer Name _____ Contact _____

Street Address _____

City _____ State _____ Zip _____

Phone _____ Fax _____

Email _____

UPHOLSTERY INFORMATION

Mill/Supplier _____ Pattern Name _____ Pattern Number _____

Color Name _____ Upholstery Material Content _____

Description _____

Required Information

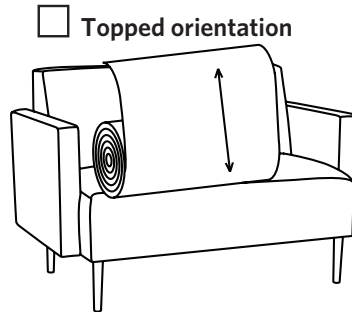
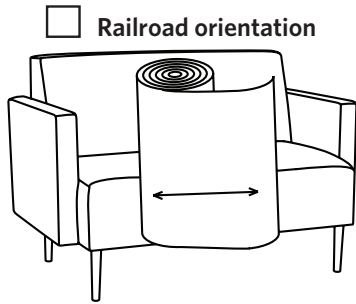

Repeat Size (in inches):

Vertical _____

Horizontal _____

- COM/COL orders will not be scheduled for production until all upholsteries have been received.
- Yardage requirements shown in the HPFi Price Book are based upon the use of 54" wide, non-directional upholstery applied in the "Topped" orientation.
- COM upholsteries are priced as Grade 2
- COL leathers are priced at Grade 3

ORDER INFORMATION

NOTE: When combination upholsteries are required, line art indicating the specific location of each upholstery must be submitted.

Quantity	HPFi Seating Item Number	Description	PO #

WARRANTY INFORMATION

- Please see Technical Specifications in HPFi Price Book for complete COM/COL specifications.
- HPFi does not warranty the quality of COM/COL materials. It is the responsibility of the supplier of the material.
- COM/COL upholsteries are not covered by any warranties expressed or implied by HPFi including, but not limited to wearability, light fastness or tailoring.

Please include reseller (dealer) name and PO # on COM supplier packing list.

Ship Prepaid To:

HPFi c/o COM Coordinator
1104 Bedford Street
High Point, NC 27263

Section Below To Be Completed By HPFi

COM / COL Yardage Requirements (as requested) _____

Date _____ Signature _____

Any changes to the above information will require new authorization. HPFi is not responsible for dye lot variations.

ERGONOMIC FEATURES & APPLICATIONS

Ergonomics, also referred to as Biotechnology of Human Engineering, is an applied science concerned with the characteristics of people that need to be considered in designing and arranging things that they use in order that people and things will interact more effectively, comfortably, and safely.

With respect to the office worker, ergonomics is applied to accommodate specific work postures that reduce or eliminate static loading of muscles, particularly in the neck, shoulder and lower back regions. These are the primary areas where musculo-skeletal illnesses occur, causing discomfort and pain.

In recent years we have, through the study of ergonomics, gained an increased understanding of the importance of prevention, in contrast to cure, for the seated individual. The result is new seating designs incorporating proper curvatures as well as individual adjustability. This seating construction has the following features and benefits:

- Front of seat is a "waterfall" shape which avoids restriction of circulation of blood in thighs and lower legs.
- Back support is designed with a compound curve to support lumbar vertebrae and help back hold a slightly forward arch. Fixed Lumbar Support has been incorporated into various chairs. Permanent fixed support allows proper passive ergonomic alignment of the skeletal frame.
- The seat cushion has only light, but relatively firm padding so the posterior can change pressure areas easily. Most seats are constructed with matrix support, as opposed to a platform (solid) seat pan. This increases comfort and works to reduce or eliminate pressure areas.
- Seat heights are adjustable to accommodate a wider range of user heights.

- Seat controls are designed to be able to adjust both the back and the seat for varying positions and tasks.
- For safety, chair bases have 5 prongs. This also makes lateral movement easier.

As well as having all of the above features and benefits required to satisfy tasks that need to be performed. HPFi seating blends into the most discriminating office environment. Actuating paddles and knobs are positioned within easy reach from the seated position and placed to avoid injury or inadvertent operation.

BASES

A. Wood Base:

A five prong steel understructure is continuously welded to a steel center hub for strength and durability. The center hub is equipped with a nylon hub liner to provide smooth and quiet swivel operation. Hardwood caps are secured to the steel understructure. The base is furnished with a black metal sleeve and features black polyimide, non-abrasive, non-marking dual wheel casters. These bases meet or exceed all BIFMA requirements.

B. Low-Profile Base:

Optional Leaders base features 5-prong die-cast aluminum under structure. Flat hardwood caps are finished and affixed to the aluminum under structure. This option meets or exceeds all BIFMA requirements.

C. Black Nylon Base:

Black five prong base of reinforced nylon resin. The base features integrated two inch hooded dual wheel casters. These bases meet or exceed all BIFMA requirements.

Note: The black nylon five prong base can be substituted for a five prong wood base at no up-charge.











IMPORTANT: When ordering a replacement base or casters, please list the seating model number and the date of purchase (if known), found on the manufacturer label under the seat.

PACKING

Prices shown in this Price Book include packaging. All items are packed one to a carton except where indicated. All packaging meets or exceeds the specifications outlined in the Uniform Freight Classification.

HPFi reserves the right to change or modify any of our products, pricing or packaging without advance notice.

All Swivel Seating includes 360° Swivel and Pneumatic Seat Height Adjustment

	Standard	Optional
 <p>Swivel Tilt Mechanism</p> <ul style="list-style-type: none"> • Seat and back tilt as one unit • Tilt pivot point is at top of cylinder/column • Adjustable tilt tension 	All (except 500, 590)	
 <p>Knee Tilt Mechanism</p> <ul style="list-style-type: none"> • Feet remain on floor when reclining • Seat and back tilt as one unit • Tilt pivot point is toward seat front • Adjustable tilt tension and tilt lock 	1231, 1237	1200 Series, 3900 Series, Leaders, Quick Silver, Scoop, Traditional, Trifecta, Value Traditional
 <p>Seat Slider Mechanism</p> <ul style="list-style-type: none"> • Seat slides forward/back to adjust seat depth 	621, 627	
 <p>Synchro Tilt (YM) Mechanism</p> <ul style="list-style-type: none"> • Back tilt/reclines at 2:1 ratio to seat angle • Tilt pivot point is at top of cylinder/column • Adjustable tilt tension 	631, 637, 751, 752	
 <p>Adjustable Back Height</p> <ul style="list-style-type: none"> • Raise / lower back for individual comfort • Lift back to engage mechanism 	500, 590, 50050AT, 59050AT, 621, 627, 631, 637	
 <p>Adjustable Width Arms</p> <ul style="list-style-type: none"> • Adjust side to side for individual comfort • Loosen knobs under seat to adjust 	50050AT, 59050AT 621, 627, 631, 637	
 <p>Adjustable Height Arms</p> <ul style="list-style-type: none"> • Adjust up and down for individual comfort 	50050AT, 59050AT 621, 627, 631, 637 751, 752	
 <p>Back Angle Adjustment</p> <ul style="list-style-type: none"> • Provides optimum lumbar support for back pressure relief and an extended range of motion • Locks into position for hands-free comfort 	621, 627, 631, 637	
 <p>Forward Seat Tilt</p> <ul style="list-style-type: none"> • Allows seat to tilt forward for lengthy computing • Keeps feet on floor and thighs in a horizontal, non-restrictive position • Provides back pressure relief and extends range of motion 	621, 627, 631, 637	
 <p>Tilt Lock</p> <ul style="list-style-type: none"> • Securely lock chair in position 	621, 627, 631, 637	

Jury Base

A 9 1/4" base with a 90° swivel (45° to each side) with automatic return to the front, forward position is available on several of our management swivel chairs. Specify code JB and add \$315 to the list price.

Caster Kit

To convert a chair (already in use) from carpet casters to hard floor casters, order a Hard Floor Caster Kit which includes 5 casters at a list price of \$40.

Caster Options

HPFi swivel seating features standard dual-wheel carpet casters appropriate for most business environments.

SEATING FINISHES

HPFi

High Point, USA

	Black	Boardwalk	Driftwood	Espresso	Graphite	Honey Cherry	Mahogany	Natural	Moab	Rouge Mahogany	Shoreline	Windsor Cherry
Meeting												
Milan Chairs							*					
Healthcare												
Haley	*	*	*	*		*	*	*	*	*	*	*
Arm Cap Option	*	*	*	*		*	*	*	*	*	*	*
Lounge												
9100 Series	*	*	*	*		*	*	*	*	*	*	*
Accompany	*	*	*	*		*	*	*	*	*	*	*
Chesterfield	*	*	*	*		*	*		*	*	*	*
Eve (wood leg option)	*	*	*	*		*	*	*	*	*	*	*
Genesis	*	*	*	*		*	*	*	*	*	*	*
Himalaya	*	*	*	*		*	*	*	*	*	*	*
Kimberly	*	*	*	*		*	*	*	*	*	*	*
Lauren	*	*	*	*		*	*	*	*	*	*	*
Rebecca	*	*	*	*		*	*	*	*	*	*	*
Scarlet	*	*	*	*		*	*	*	*	*	*	*
Traditional	*	*	*	*		*	*		*	*	*	*
Office Seating												
1200 Series	*	*	*	*		*	*	*	*	*	*	*
3900 Series	*	*	*	*		*	*	*	*	*	*	*
Leaders	*	*	*	*		*	*	*	*	*	*	*
Quick Silver Contemporary	*	*	*	*		*	*	*	*	*	*	*
Quick Silver Traditional	*	*	*	*		*	*		*	*	*	*
Scoop Contemporary	*	*	*	*		*	*	*	*	*	*	*
Scoop Traditional	*	*	*	*		*	*		*	*	*	*
Traditional	*	*	*	*		*	*		*	*	*	*
Trifecta	*	*	*	*		*	*	*	*	*	*	*
Guest/Ganging												
9100 Series	*	*	*	*		*	*	*	*	*	*	*
Contempo	*	*	*	*		*	*	*	*	*	*	*
Corbel	*	*	*	*		*	*	*	*	*	*	*
Trados	*	*	*	*		*	*	*	*	*	*	*
Unos	*	*	*	*		*	*	*	*	*	*	*
Occasional Tables												
6700 Veneer	*	*	*	*		*	*	*	*	*	*	*
6700 Laminate	*	*	*	*			*	*			*	*
9100 Series	*	*	*	*		*	*	*	*	*	*	*
Bedford							*					*
Hyperwork	*	*	*	*	*		*	*			*	*
Malibu	*	*	*	*	*		*	*			*	
Marquet						*				*		
Trados Metal	*	*	*	*	*		*	*			*	*

WOOD FINISHES

Finishes available as standard on our wood seating products are for the exposed wood components. This wood is kiln dried maple and similar hardwoods.

ANTIMICROBIAL /ANTIBACTERIAL

HPFi employs a proprietary seating finish under the name, Sentinel™. Our finish employs silver ions - a powerful, natural antimicrobial, antibacterial which assists in preventing the spread of infections without harm to human health. Disease-causing organisms on wood chair frames with Sentinel™ antimicrobial silver remain latent, thereby unable to propagate and soon naturally expire. Sentinel™ antimicrobial finish cannot be washed away, worn off or depleted overtime. Its effectiveness is as powerful at the end of the life cycle as it is at its start.

STANDARD COLORS

The following finishes are available as standard:

- **Aspen** - a fade resistant beige stain with a medium gloss lacquer top coat. Specify wood finish code **AP**.
- **Black** - a fade resistant black stain with a low-gloss lacquer top coat. Specify wood finish code **BLK**.
- **Boardwalk** - a fade resistant light brown/taupe stain with a medium gloss lacquer top coat formulated to be compatible with Boardwalk casegoods finish. Specify wood finish code **BW**.
- **Driftwood** - a fade resistant dark gray stain with a medium gloss lacquer top coat formulated to be compatible with the Driftwood laminate casegoods finish. Specify wood finish code **DW**.
- **Espresso** - a fade resistant dark Walnut stain with a medium gloss lacquer top coat. Specify wood finish code **ESP**.
- **Honey Cherry** - a fade resistant orange-brown cherry stain with a medium gloss lacquer top coat. Formulated to match our Honey Cherry veneer casegoods. Specify wood finish code **HCY**.
- **Mahogany** - a fade resistant mahogany stain with a medium gloss lacquer top coat. Specify wood finish code **MAH**.
- **Natural** - a clear lacquer gloss top coat. Specify wood finish code **FM**.
- **Moab** - a fade resistant medium-brown stain with a medium-gloss top coat. Specify wood finish code **MOB**.
- **Rouge Mahogany** - a multi-step reddish brown finish with high-gloss top coat matching veneer casegoods. Specify wood finish code **RM**.
- **Shoreline** - a fade resistant grey stain with a medium gloss lacquer top coat. Formulated to be compatible with Shoreline casegoods finish. Specify wood finish code **SL**.
- **Windsor Cherry** - a fade resistant red-brown cherry stain with a medium gloss lacquer top coat. Specify wood finish code **WC**.

When ordering, please specify the quantity of each model, the complete model number, followed by a dash, the wood finish code, followed by the fabric name and fabric number. Example: To order 15 of model 1621 in a Driftwood finish in CF Stinson's Satellite 62826 Domino, your order should read:

15 1621 DW Satellite Domino

The standard finishes available for each seating product are specified by a wood finish code suffix. Wood finishes are available as noted on each page of this Price Book. The following legend for the wood finish code is listed on each page of products available with a wood finish.

WOOD FINISH CODES

AP (Aspen)
BLK (Black)
BW (Boardwalk)
DW (Driftwood)
FM (Natural)
ESP (Espresso)
HCY (Honey Cherry)
MAH (Mahogany)
MOB (Moab)
RM (Rouge Mahogany)
SL (Shoreline)
WC (Windsor Cherry)

Special finishes can be accommodated. Please contact our Customer Service Department for pricing and lead time. Due to additional handling, a special finish charge of \$100 one-time net fee is required.

COLOR VARIATIONS

Variations in wood color and grain pattern, contribute to the natural beauty of wood. The natural characteristics of the different species of wood, add to the distinctiveness of furniture and cannot be considered defects.

Some examples of these natural characteristics include:

- **Pitch pockets.** These are common in fruit woods such as cherry. They appear as a dark spot in the grain that may not always accept finishing materials.
- **End-grain.** This occurs on the edges of chair frames and desk tops. They appear as a color variation of the tree's growth ring, commonly called "tiger striping".
- **Color variations.** All real wood products exhibit a certain amount of color variation when finished. This color variation is most often caused by the natural difference of initial color of the raw wood. This initial color, as with many other of the characteristics of real wood, is naturally occurring and contributes to the beauty of the finished product. These color variations are more noticeable in light colored woods finished with a clear lacquer finish.

HPFi strives to control variations in color as much as practical. However, slight variations do occur naturally and should not be considered defects.

DIMENSIONS

All size dimensions listed are nominal and subject to change. If you must have exact dimensions, please contact your Customer Service Representative. Worksurface dimensions will vary due to edge profile treatment. Always measure the actual top before ordering glass or another cover to fit table tops.

SEATING LOUNGE



Sleek Lines, Comfortable Design

The sleek lines of the **Eve Collection** take shape from the desire to provide a contemporary solution to reception areas, waiting rooms, open plan team areas, lobbies and training rooms. This extensive collection includes teaming, linear, curved seating and ganging brackets.

Power Option

Power modules can be installed in arms or in front. See page 135.

Additional Information

- Eve includes 60° loveseats and benches plus 30° chairs, benches and wedge tables. Both 60° loveseats and 30° chairs are available with an inside or outside facing back.

- Eve's taut upholstery highlights this collection's contemporary look
- Brushed aluminum cylinder legs with adjustable glides
- Wood leg available at same price. Add WL after the model number and specify finish from chart on page 164.



Eve

5801 Club Chair with Arms

30" W X 31" D X 34" H

St. Yardage: 4.25

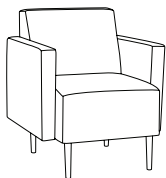

FREIGHT CLASS: 250
CUBIC FT: 31
SHIP WEIGHT: 80

QS NOW

Grade	1	2	3	4	5	6	7	8	9	10	L	LL
Zone 1	1813	1864	1884	1961	2031	2100	2192	2283	2374	2464	2522	2579
Zone 2	1840	1892	1912	1990	2061	2132	2225	2317	2410	2501	2560	2618
Zone 3	1867	1920	1941	2020	2092	2163	2258	2351	2445	2538	2598	2656

- Sytex sheet webbing for long term support
- Fully upholstered seat/back/arms
- See other features above
- Seat: 22"W x 20"D x 19.5"H

5802 Loveseat with Arms

53" W X 31" D X 34" H

St. Yardage: 6.25

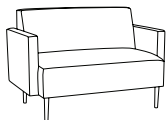

FREIGHT CLASS: 250
CUBIC FT: 57
SHIP WEIGHT: 92

QS NOW

Grade	1	2	3	4	5	6	7	8	9	10	L	LL
Zone 1	2317	2417	2454	2535	2636	2737	2871	3006	3140	3276	3319	3442
Zone 2	2352	2453	2491	2573	2676	2778	2914	3051	3187	3325	3369	3494
Zone 3	2387	2490	2528	2611	2715	2819	2957	3096	3234	3374	3419	3545

- Sytex sheet webbing for long term support
- Fully upholstered seat/back/arms
- See other features above
- Seat: 45"W x 20"D x 19.5"H

5803 Sofa with Arms

73.5" W X 31" D X 34" H

St. Yardage: 8

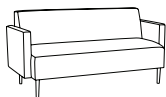

FREIGHT CLASS: 250
CUBIC FT: 77
SHIP WEIGHT: 143

QS NOW

Grade	1	2	3	4	5	6	7	8	9	10	L	LL
Zone 1	2797	2947	3005	3077	3206	3336	3508	3851	4022	4238	4301	4648
Zone 2	2839	2991	3050	3123	3254	3386	3561	3909	4082	4302	4366	4718
Zone 3	2881	3035	3095	3169	3302	3436	3613	3967	4143	4365	4430	4787

- Sytex sheet webbing for long term support
- Fully upholstered seat/back/arms
- See other features above
- Seat: 66"W x 20"D x 19.5"H

5804 Armless Chair



FREIGHT CLASS: 250
CUBIC FT: 31
SHIP WEIGHT: 57

22.5" W X 31" D X 34" H

St. Yardage: 3

Grade	1	2	3	4	5	6	7	8	9	10	L	LL
Zone 1	1602	1651	1672	1707	1755	1804	1868	1932	1997	2062	2228	2581
Zone 2	1626	1676	1697	1733	1781	1831	1896	1961	2027	2093	2261	2620
Zone 3	1650	1701	1722	1758	1808	1858	1924	1990	2057	2124	2295	2658

- Sytex sheet webbing for long term support
- Fully upholstered seat/back
- See other features in series overview
- Seat: 22"W x 20"D x 19.5"H

QS NOW

5805 Armless Loveseat



FREIGHT CLASS: 250
CUBIC FT: 57
SHIP WEIGHT: 105

45.5" W X 31" D X 34" H

St. Yardage: 4.75

Grade	1	2	3	4	5	6	7	8	9	10	L	LL
Zone 1	2106	2206	2244	2272	2347	2424	2527	2629	2730	2834	2877	2961
Zone 2	2138	2239	2278	2306	2382	2460	2565	2668	2771	2877	2920	3005
Zone 3	2169	2272	2311	2340	2417	2497	2603	2708	2812	2919	2963	3050

- Sytex sheet webbing for long term support
- Fully upholstered seat/back
- See other features in series overview
- Seat: 45"W x 20"D x 19.5"H

QS NOW

5806 Armless Sofa

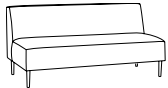

FREIGHT CLASS: 250
CUBIC FT: 75
SHIP WEIGHT: 134

67" W X 31" D X 34" H

St. Yardage: 7.25

Grade	1	2	3	4	5	6	7	8	9	10	L	LL
Zone 1	2588	2733	2791	2840	2957	3073	3228	3387	3542	3698	3745	3893
Zone 2	2627	2774	2833	2883	3001	3119	3276	3438	3595	3753	3801	3951
Zone 3	2666	2815	2875	2925	3046	3165	3325	3489	3648	3809	3857	4010

- Sytex sheet webbing for long term support
- Fully upholstered seat/back
- See other features in series overview
- Seat: 66"W x 20"D x 19.5"H

QS NOW

5830 30° Bench



FREIGHT CLASS: 175
CUBIC FT: 16
SHIP WEIGHT: 57

37.5" W X 29.5" D X 19.5" H

St. Yardage: 2.75

Grade	1	2	3	4	5	6	7	8	9	10	L	LL
Zone 1	1571	1673	1709	1735	1756	1815	1874	1934	1993	2068	2115	2323
Zone 2	1595	1698	1735	1761	1782	1842	1902	1963	2023	2099	2147	2358
Zone 3	1618	1723	1760	1787	1809	1869	1930	1992	2053	2130	2178	2393

- Sytex sheet webbing for long term support
- Fully upholstered seat
- See other features in series overview
- Seat: 22.5-36.5"W x 27.5"D x 19.5"H

QS NOW

5860 60° Bench



FREIGHT CLASS: 250
CUBIC FT: 42
SHIP WEIGHT: 71

71" W X 33" D X 19.5" H

St. Yardage: 3.75

Grade	1	2	3	4	5	6	7	8	9	10	L	LL
Zone 1	2174	2320	2379	2403	2460	2532	2601	2671	2758	2925	2989	3317
Zone 2	2207	2355	2415	2439	2497	2570	2640	2711	2799	2969	3034	3367
Zone 3	2239	2390	2450	2475	2534	2608	2679	2751	2841	3013	3079	3417

- Sytex sheet webbing for long term support
- Fully upholstered seat
- Use with other curved units to form curves, circles or serpentine shapes
- See other features in series overview
- Seat: 44-70"W x 27.5"D x 19.5"H

QS NOW

5831 One-Seat Bench

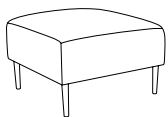

FREIGHT CLASS: 175
CUBIC FT: 16
SHIP WEIGHT: 30

22.5" W X 28.5" D X 19.5" H

St. Yardage: 1.75

Grade	1	2	3	4	5	6	7	8	9	10	L	LL
Zone 1	1451	1501	1521	1540	1568	1607	1645	1682	1720	1767	1835	1915
Zone 2	1473	1524	1544	1563	1592	1631	1670	1707	1746	1794	1863	1944
Zone 3	1495	1546	1567	1586	1615	1655	1694	1732	1772	1820	1890	1972

- Sytex sheet webbing for long term support
- Fully upholstered seat
- See other features in series overview
- Seat: 22"W x 28"D x 19.5"H

QS NOW

5832 Two-Seat Bench

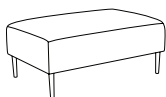

FREIGHT CLASS: 250
CUBIC FT: 57
SHIP WEIGHT: 50

QS NOW

45.5" W X 28.5" D X 19.5" H St. Yardage: 2.75

Grade	1	2	3	4	5	6	7	8	9	10	L	LL
Zone 1	1917	2016	2054	2101	2161	2220	2279	2337	2413	2552	2689	2885
Zone 2	1946	2046	2085	2133	2193	2253	2313	2372	2449	2590	2729	2928
Zone 3	1975	2076	2116	2164	2226	2287	2347	2407	2485	2629	2770	2972

- Sytex sheet webbing for long term support
- Fully upholstered seat
- See other features in series overview
- Seat: 45"W x 28"D x 19.5"H

5833 Three-Seat Bench

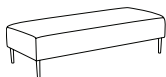

FREIGHT CLASS: 250
CUBIC FT: 75
SHIP WEIGHT: 93

QS NOW

67" W X 28.5" D X 19.5" H St. Yardage: 4

Grade	1	2	3	4	5	6	7	8	9	10	L	LL
Zone 1	2360	2508	2567	2590	2646	2718	2787	2858	2945	3111	3176	3503
Zone 2	2395	2546	2606	2629	2686	2759	2829	2901	2989	3158	3224	3556
Zone 3	2431	2583	2644	2668	2725	2800	2871	2944	3033	3204	3271	3608

- Sytex sheet webbing for long term support
- Fully upholstered seat
- See other features in series overview
- Seat: 66"W x 28"D x 19.5"H

5865-OF 60° Loveseat (Outside Facing)



FREIGHT CLASS: 250
CUBIC FT: 76
SHIP WEIGHT: 122

QS NOW

71" W X 36.5" D X 34" H St. Yardage: 7

Grade	1	2	3	4	5	6	7	8	9	10	L	LL
Zone 1	2642	2743	2781	2840	2914	3038	3164	3331	3496	3665	3831	4039
Zone 2	2682	2784	2823	2883	2958	3084	3211	3381	3548	3720	3888	4100
Zone 3	2721	2825	2864	2925	3001	3129	3259	3431	3601	3775	3946	4160

- Sytex sheet webbing for long term support
- Fully upholstered seat/back
- See other features in series overview
- Seat: 53-70"W x 20"D x 19.5"H

5865-IF 60° Loveseat (Inside Facing)

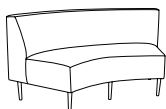

FREIGHT CLASS: 250
CUBIC FT: 76
SHIP WEIGHT: 135

QS NOW

74.5" W X 36.5" D X 34" H St. Yardage: 7.75

Grade	1	2	3	4	5	6	7	8	9	10	L	LL
Zone 1	2642	2743	2781	2840	2914	3038	3164	3331	3496	3665	3831	4039
Zone 2	2682	2784	2823	2883	2958	3084	3211	3381	3548	3720	3888	4100
Zone 3	2721	2825	2864	2925	3001	3129	3259	3431	3601	3775	3946	4160

- Sytex sheet webbing for long term support
- Fully upholstered seat/back
- Use with other curved units to form curves, circles or serpentine shapes
- See other features in series overview
- Seat: 44-63.5"W x 20"D x 19.5"H

5835-OF 30° Chair (Outside Facing)

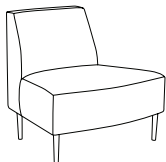

FREIGHT CLASS: 250
CUBIC FT: 31
SHIP WEIGHT: 74

QS NOW

37.5" W X 33" D X 34" H St. Yardage: 4

Grade	1	2	3	4	5	6	7	8	9	10	L	LL
Zone 1	1734	1783	1803	1833	1892	1951	2020	2065	2111	2202	2385	2500
Zone 2	1760	1810	1830	1860	1920	1980	2050	2096	2143	2235	2421	2538
Zone 3	1786	1836	1857	1888	1949	2010	2081	2127	2174	2268	2457	2575

- Sytex sheet webbing for long term support
- Fully upholstered seat/back
- See other features in series overview
- Seat: 23-32.5"W x 20"D x 19.5"H

5835-IF 30° Chair (Inside Facing)



FREIGHT CLASS: 250
CUBIC FT: 40
SHIP WEIGHT: 79

QS NOW

39" W X 33" D X 34" H St. Yardage: 4.25

Grade	1	2	3	4	5	6	7	8	9	10	L	LL
Zone 1	1734	1783	1803	1833	1892	1951	2020	2065	2111	2202	2385	2500
Zone 2	1760	1810	1830	1860	1920	1980	2050	2096	2143	2235	2421	2538
Zone 3	1786	1836	1857	1888	1949	2010	2081	2127	2174	2268	2457	2575

- Sytex sheet webbing for long term support
- Fully upholstered seat/back
- See other features in series overview
- Seat: 23-32.5"W x 20"D x 19.5"H

5843 Armless Sofa/Bench with 2/3 Back-Right

67" W X 31" D X 34" H

St. Yardage: 6.5

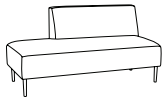

SIN #711-17

FREIGHT CLASS: 250
CUBIC FT: 74
SHIP WEIGHT: 132

Grade	1	2	3	4	5	6	7	8	9	10	L	LL
Zone 1	2538	2653	2787	2897	3009	3159	3310	3460	3611	3798	4207	4544
Zone 2	2576	2693	2829	2940	3054	3206	3360	3512	3665	3855	4270	4612
Zone 3	2614	2733	2871	2984	3099	3254	3409	3564	3719	3912	4333	4680

- Stylish 2/3 back on right adds dimension
- Sytex sheet webbing for long term support
- Fully upholstered seat/back
- 3 optional arm styles available, must be factory installed
- Seat: 66" W x 20-28" D X 19.5" H

QS NOW

5844 Armless Sofa/Bench with 2/3 Back-Left

67" W X 31" D X 34" H

St. Yardage: 6.5

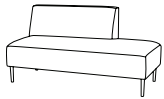

SIN #711-17

FREIGHT CLASS: 250
CUBIC FT: 74
SHIP WEIGHT: 132

Grade	1	2	3	4	5	6	7	8	9	10	L	LL
Zone 1	2538	2653	2787	2897	3009	3159	3310	3460	3611	3798	4207	4544
Zone 2	2576	2693	2829	2940	3054	3206	3360	3512	3665	3855	4270	4612
Zone 3	2614	2733	2871	2984	3099	3254	3409	3564	3719	3912	4333	4680

- Stylish 2/3 back on left adds dimension
- Sytex sheet webbing for long term support
- Fully upholstered seat/back
- 3 optional arm styles available, must be factory installed
- Seat: 66" W x 20-28" D X 19.5" H

QS NOW

5853 Armless Lounge with Opposing Backs

67" W X 31" D X 34" H

St. Yardage: 7.25

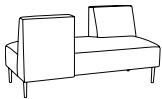

SIN #711-17

FREIGHT CLASS: 250
CUBIC FT: 74
SHIP WEIGHT: 132

Grade	1	2	3	4	5	6	7	8	9	10	L	LL
Zone 1	2661	2783	2927	3043	3164	3325	3486	3647	3809	4011	4449	4843
Zone 2	2701	2825	2971	3089	3211	3375	3538	3702	3866	4071	4516	4916
Zone 3	2741	2866	3015	3134	3259	3425	3591	3756	3923	4131	4582	4988

- Opposing backs encourage face-to-face conversation
- Sytex sheet webbing for long term support
- Fully upholstered seat/back
- 3 optional arm styles available, must be factory installed
- Seat: 66" W x 20-28" D X 19.5" H

QS NOW

5836_ 30° Connecting/Freestanding Wedge Table

37.5" W X 29.5" D X 16" H

St. Yardage: 1.5

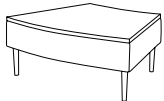

SIN #711-11

FREIGHT CLASS: 175
CUBIC FT: 18
SHIP WEIGHT: 72

Grade	1	2	3	4	5	6	7	8	9	10	L	LL
Zone 1	1241	1290	1309	1324	1339	1373	1406	1439	1470	1509	1587	1768
Zone 2	1260	1309	1329	1344	1359	1394	1427	1461	1492	1532	1611	1795
Zone 3	1278	1329	1348	1364	1379	1414	1448	1482	1514	1554	1635	1821

- Thermally fused laminate top
- Taut-upholstered sides for a contemporary appearance

Finish Options: Black (E), Boardwalk (BW), Driftwood (DW), Espresso (ESP), Graphite (GP), Mahogany (MAH), Natural Maple (FM), Shoreline (SL), Windsor Cherry (WC)

Quick Ship Finishes: Black (BLK), Natural Maple (FM), Windsor Cherry (WC)

QS NOW

5823_ Connecting/Freestanding Table

23" W X 27" D X 16" H

St. Yardage: 1

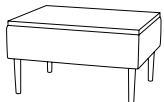

SIN #711-11

FREIGHT CLASS: 175
CUBIC FT: 9
SHIP WEIGHT: 49

Grade	1	2	3	4	5	6	7	8	9	10	L	LL
Zone 1	1206	1255	1275	1285	1305	1339	1371	1403	1437	1476	1554	1734
Zone 2	1224	1274	1294	1304	1325	1359	1392	1424	1459	1498	1577	1760
Zone 3	1242	1293	1313	1324	1344	1379	1412	1445	1480	1520	1601	1786

- Thermally fused laminate top
- Taut-upholstered sides for a contemporary appearance

Finish Options: Black (E), Boardwalk (BW), Driftwood (DW), Espresso (ESP), Graphite (GP), Mahogany (MAH), Natural Maple (FM), Shoreline (SL), Windsor Cherry (WC)

Quick Ship Finishes: Black (BLK), Natural Maple (FM), Windsor Cherry (WC)

QS NOW

5895 90° Corner Seat

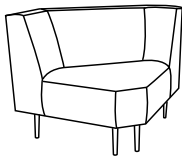

FREIGHT CLASS: 250
CUBIC FT: 40
SHIP WEIGHT: 110

51.5" W X 31.75" D X 34" H St. Yardage: 7

Grade	1	2	3	4	5	6	7	8	9	10	L	LL
Zone 1	2864	2950	3052	3138	3224	3340	3456	3571	3686	3832	4105	4756
Zone 2	2907	2994	3098	3185	3272	3390	3508	3625	3741	3889	4167	4827
Zone 3	2950	3039	3144	3232	3321	3440	3560	3678	3797	3947	4228	4899

- 90° application for corners
- 6-sided shape
- Fully upholstered seat and back
- 8" brushed aluminum cylinder legs with adjustable glides
- Seat 8-35" W x 19" D x 19.5" H

QS NOW

5890 90° Corner Bench

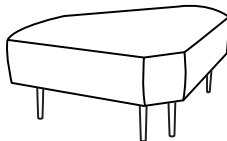

FREIGHT CLASS: 250
CUBIC FT: 35
SHIP WEIGHT: 90

51.5" W X 31.75" D X 19.5" H St. Yardage: 4

Grade	1	2	3	4	5	6	7	8	9	10	L	LL
Zone 1	2006	2051	2104	2149	2195	2255	2316	2376	2436	2512	2656	2997
Zone 2	2036	2082	2136	2181	2228	2289	2351	2412	2473	2550	2696	3042
Zone 3	2066	2113	2167	2213	2261	2323	2385	2447	2509	2587	2736	3087

- 90° application for corners
- 6-sided shape
- Fully upholstered seat
- 8" brushed aluminum cylinder legs with adjustable glides
- Seat 8-51" W x 31.75" D x 19.5" H

QS NOW

5809 Club Chair with arms and returning swivel base

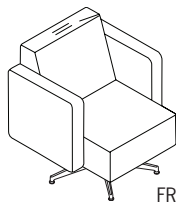

FREIGHT CLASS: 250
CUBIC FT: 30.5
SHIP WEIGHT: 98

30" W X 31" D X 34" H St. Yardage: 4.25

Grade	1	2	3	4	5	6	7	8	9	10	L	LL
Zone 1	1899	1962	2035	2098	2161	2245	2329	2413	2497	2602	2802	3274
Zone 2	1927	1991	2066	2129	2193	2279	2364	2449	2534	2641	2844	3323
Zone 3	1956	2021	2096	2161	2226	2312	2399	2485	2572	2680	2886	3372

- Fully-upholstered seat/back/arms
- Five-star, return-swivel base in a chrome finish on glides
- Base swivels to right or left by 45° and always returns to original position

QS NOW

5807 Armless Chair with returning swivel base

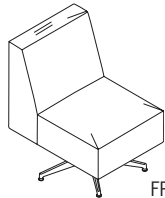

FREIGHT CLASS: 250
CUBIC FT: 30.5
SHIP WEIGHT: 89

25.5" W X 31" D X 34" H St. Yardage: 3

Grade	1	2	3	4	5	6	7	8	9	10	L	LL
Zone 1	1499	1543	1595	1640	1684	1744	1803	1862	1921	1996	2136	2470
Zone 2	1521	1566	1619	1665	1709	1770	1830	1890	1950	2026	2168	2507
Zone 3	1544	1589	1643	1689	1735	1796	1857	1918	1979	2056	2200	2544

- Fully-upholstered seat and back
- Five-star, return-swivel base in a chrome finish on glides
- Base swivels to right or left by 45° and always returns to original position

QS NOW

5827 Club/Teaming Chair

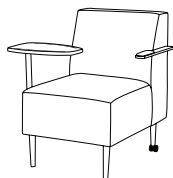

FREIGHT CLASS: 250
CUBIC FT: 28
SHIP WEIGHT: 58

24.5" W X 31" D X 34" H St. Yardage: 3.25

Grade	1	2	3	4	5	6	7	8	9	10	L	LL
Zone 1	2174	2223	2244	2272	2304	2365	2425	2507	2588	2643	2848	3039
Zone 2	2207	2256	2278	2306	2339	2400	2461	2545	2627	2683	2891	3085
Zone 3	2239	2290	2311	2340	2373	2436	2498	2582	2666	2722	2933	3130

- Sytex sheet webbing
- Solid aluminum handle on back for easy relocation
- Adjustable glides on front and 2.5" casters on back
- Aluminum arm right side facing standard
- Aluminum pole with black or wood finish tablet which rotates 360° on left side facing standard
- Wood finish tablet available in the finishes listed
- See other features in series overview
- Seat: 22"W x 20"D x 19.5"H

Finish Options for Tablet: Aspen (AP), Black (E), Boardwalk (BW), Driftwood (DW), Espresso (ESP), Honey Cherry (HCY), Mahogany (MAH), Moab (MOB), Natural Maple (FM), Windsor Cherry (WC), Rouge Mahogany (RM) and Shoreline (SL)

QS NOW

5827UA Club/Teaming Chair with Upholstered Arms

30" W X 31" D X 34" H

St. Yardage: 5

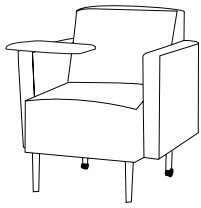

FREIGHT CLASS: 250
CUBIC FT: 28
SHIP WEIGHT: 70

QS NOW

Grade	1	2	3	4	5	6	7	8	9	10	L	LL
Zone 1	2174	2223	2244	2272	2304	2365	2425	2507	2588	2643	2848	3039
Zone 2	2207	2256	2278	2306	2339	2400	2461	2545	2627	2683	2891	3085
Zone 3	2239	2290	2311	2340	2373	2436	2498	2582	2666	2722	2933	3130

- Sytex sheet webbing
- Solid aluminum handle on back for easy relocation
- Fully upholstered seat/back/arms
- Anodized brushed aluminum cylinder legs, adjustable glides on front and 2.5" casters on back
- Black or wood finish tablet rotates 360°
- Tablet easily relocates on left or right
- Wood finish tablet available in the finishes listed
- See other features in series overview
- Seat: 22"W x 20"D x 19.5"H

Finish Options for Tablet: Aspen (AP), Black (E), Boardwalk (BW), Driftwood (DW), Espresso (ESP), Honey Cherry (HCY), Mahogany (MAH), Moab (MOB), Natural Maple (FM), Windsor Cherry (WC), Rouge Mahogany (RM) and Shoreline (SL)

5825 Mobile Armless Chair on Casters

22.5" W X 33/44" D X 38.5" H

St. Yardage: 3

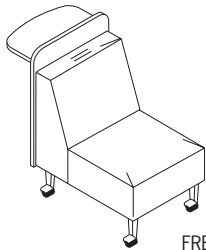

FREIGHT CLASS: 250
CUBIC FT: 49.7
SHIP WEIGHT: 96

QS NOW

Grade	1	2	3	4	5	6	7	8	9	10	L	LL
Zone 1	2496	2546	2605	2650	2694	2761	2820	2887	2946	3020	3198	3532
Zone 2	2533	2584	2644	2690	2734	2802	2862	2930	2990	3065	3246	3585
Zone 3	2571	2622	2683	2730	2775	2844	2905	2974	3034	3111	3294	3638

- Upholstered seat and back
- Laminate back panel with flip-up shelf which locks into position
- Shelf is useful for mobile devices, writing surface or as beverage holder
- Brushed aluminum cylinder legs on dual wheel casters

Finish Options: Black (E), Boardwalk (BW), Driftwood (DW), Espresso (ESP), Graphite (GP), Mahogany (MAH), Natural Maple (FM), Shoreline (SL), Windsor Cherry (WC)

5820 Technology Arm with Flared/Curved Laminate Top

18" W X 34.5" D X 28.5" H

St. Yardage: 2.5

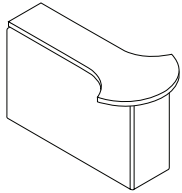

FREIGHT CLASS: 250
CUBIC FT: 14.7
SHIP WEIGHT: 51

QS NOW

Grade	1	2	3	4	5	6	7	8	9	10	L	LL
Zone 1	1169	1211	1260	1297	1334	1390	1439	1495	1544	1606	1754	2032
Zone 2	1187	1229	1279	1316	1354	1411	1461	1517	1567	1630	1780	2062
Zone 3	1204	1247	1298	1336	1374	1432	1482	1540	1590	1654	1807	2093

- Flared/Curved Laminate Top on upholstered base
- Includes two 58B connecting kits
- Must be attached between two adjoining Eve seating units

Finish Options: Black (E), Boardwalk (BW), Driftwood (DW), Espresso (ESP), Graphite (GP), Mahogany (MAH), Natural Maple (FM), Shoreline (SL), Windsor Cherry (WC)

UA Upholstered Arms

3.75" W X 22" D X 19.5" H

St. Yardage: 3



FREIGHT CLASS: 70
CUBIC FT:
SHIP WEIGHT: 18

QS NOW

Grade	1	2	3	4	5	6	7	8	9	10	L	LL
Zone 1	240	338	378	393	442	506	570	635	700	758	782	928
Zone 2	244	343	384	399	449	514	579	645	711	769	794	942
Zone 3	247	348	389	405	455	521	587	654	721	781	805	956

- UA = 2 upholstered arms
- Add UA to end of item number and price of arms to unit price
- Must be ordered as factory installed

UAL/UAR Left or Right Upholstered Arm

3.75" W X 22" D X 19.5" H

St. Yardage: 1.5



FREIGHT CLASS: 70
CUBIC FT:
SHIP WEIGHT: 9

QS NOW

Grade	1	2	3	4	5	6	7	8	9	10	L	LL
Zone 1	120	170	189	197	221	254	285	317	350	379	391	465
Zone 2	122	173	192	200	224	258	289	322	355	385	397	472
Zone 3	124	175	195	203	228	262	294	327	361	390	403	479

- UAL = Left arm facing
- UAR = Right arm facing
- Add UAL or UAR to end of item number and add arm price to unit price
- Price is per arm
- Must be ordered as factory installed

TAL/TAR Tablet Arm on Aluminum Pole



FREIGHT CLASS: 70

- TAL = Mounted on left side facing
- TAR = Mounted on right side facing
- Solid aluminum pole attaches to side of seat
- Black or wood finish tablet rotates 360°
- Add TAL or TAR to end of item number and tablet arm price to unit price
- Must be ordered as factory installed

		Zone Pricing	1	2	3
17" W X 10.75" D X 19" H	Cubic Ft:	Ship Weight: 8	560	568	577

Finish Options for Tablet: Aspen (AP), Black (E), Boardwalk (BW), Driftwood (DW), Espresso (ESP), Honey Cherry (HCY), Mahogany (MAH), Moab (MOB), Natural Maple (FM), Windsor Cherry (WC), Rouge Mahogany (RM) and Shoreline (SL)

QS

58B Ganging Bracket Kit

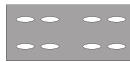

- 11 gauge steel
- Black powdercoat
- Need one ganging bracket kit for each connection
- Kit includes two brackets

8" W X 3" D	Cubic Ft:	Ship Weight: 2	36	37	37
-------------	-----------	----------------	-----------	-----------	-----------

FREIGHT CLASS: 70

QS

5875 Banquette

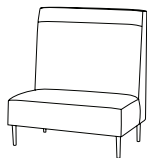

FREIGHT CLASS: 300
CUBIC FT: 61
SHIP WEIGHT: 115

45.5" W X 31" D X 52.75" H St. Yardage: 6

Grade	1	2	3	4	5	6	7	8	9	10	L	LL
Zone 1	2338	2427	2546	2634	2723	2857	2975	3109	3227	3376	3731	4398
Zone 2	2373	2463	2584	2674	2764	2900	3020	3156	3275	3427	3787	4464
Zone 3	2408	2500	2622	2713	2805	2943	3064	3202	3324	3477	3843	4530

- Fully upholstered with double-needle trim on seat and back to reinforce seam
- High back offers comfort and privacy in open collaborative areas
- Taut upholstered seat and back
- 8" aluminum cylinder legs with adjustable glides
- Freestanding or connects with other Eve seating units or tables
- Seat: 44.5"W X 20"D X 19.5"H

QS NOW

5876 Banquette Sofa

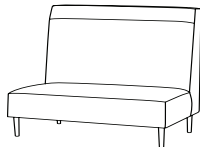

FREIGHT CLASS: 300
CUBIC FT: 87
SHIP WEIGHT: 150

67" W X 31" D X 52.75" H St. Yardage: 9.5

Grade	1	2	3	4	5	6	7	8	9	10	L	LL
Zone 1	2809	2950	3138	3278	3419	3630	3818	4029	4217	4452	5015	6071
Zone 2	2851	2994	3185	3327	3470	3684	3875	4089	4280	4519	5090	6162
Zone 3	2893	3039	3232	3376	3522	3739	3933	4150	4344	4586	5165	6253

- Sofa with extra-high back
- Offers privacy in open areas
- Fully upholstered seat and back with double needle stitching
- Brushed aluminum cylinder legs with adjustable glides

QS NOW

5875UAH Banquette with Upholstered Arms

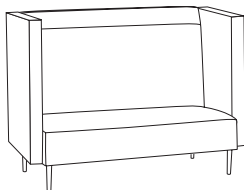

FREIGHT CLASS: 300
CUBIC FT: 60
SHIP WEIGHT: 135

53" W X 31" D X 52.75" H St. Yardage: 10

Grade	1	2	3	4	5	6	7	8	9	10	L	LL
Zone 1	2840	2988	3186	3334	3482	3707	3902	4125	4322	4569	5162	6274
Zone 2	2883	3033	3234	3384	3534	3763	3961	4187	4387	4638	5239	6368
Zone 3	2925	3078	3282	3434	3586	3818	4019	4249	4452	4706	5317	6462

- Fully upholstered with double-needle trim on seat and back to reinforce seam
- Fully upholstered high arms
- High back offers comfort and privacy in open collaborative areas
- Taut upholstered seat and back
- 8" aluminum cylinder legs with adjustable glides
- Freestanding or connects with other Eve seating units or tables
- Seat: 44.5"W X 20"D X 19.5"H

QS NOW

5876UAH Banquette Sofa with Arms



FREIGHT CLASS: 300
CUBIC FT: 94
SHIP WEIGHT: 175

73.5" W X 31" D X 52.75" H St. Yardage: 13.5

Grade	1	2	3	4	5	6	7	8	9	10	L	LL
Zone 1	3311	3511	3778	3978	4178	4478	4745	5045	5312	5645	6446	7947
Zone 2	3361	3564	3835	4038	4241	4545	4816	5121	5392	5730	6543	8066
Zone 3	3410	3616	3891	4097	4303	4612	4887	5196	5471	5814	6639	8185

- Sofa with extra-high back and arms
- Offers privacy in open areas
- Fully upholstered seat and back with double needle stitching
- Brushed aluminum cylinder legs with adjustable glides

QS NOW

5875-IF Curved Banquette Loveseat, Inside Facing

74.5"W X 36.5"D X 52.75"H

St. Yardage: 9.75

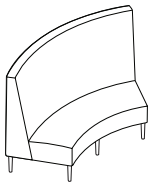

SIN #711-17

FREIGHT CLASS: 300
CUBIC FT: 86.1
SHIP WEIGHT: 163

Grade	1	2	3	4	5	6	7	8	9	10	L	LL
Zone 1	3589	3751	3944	4088	4233	4449	4642	4859	5052	5292	5871	6954
Zone 2	3643	3807	4003	4149	4296	4516	4712	4932	5128	5371	5959	7058
Zone 3	3697	3864	4062	4211	4360	4582	4781	5005	5204	5451	6047	7163

- Curved extra-high back offers privacy in open areas
- Fully upholstered seat and back with double needle stitching
- Brushed aluminum cylinder legs with adjustable glides

QS NOW

BS_ Laminate Curved Shelf for 5875-IF Banquette



SIN #711-17

FREIGHT CLASS:
CUBIC FT: 88
SHIP WEIGHT: 194

81.5"W X 10"D X 1"H

Ship Weight: 30

Zone Pricing	1	2	3
	975	990	1004

- 1" thick curved TFL laminate shelf for 5875-IF
- Shelf brackets must be factory installed
- Shelf attaches to brackets in field
- Ships installed on 5875-IF (Ship weight and cubes are for both)

Finish Options: Black (E), Boardwalk (BW), Driftwood (DW), Espresso (ESP), Graphite (GP), Mahogany (MAH), Natural Maple (FM), Shoreline (SL), Windsor Cherry (WC)

QS NOW

5875R Eve Banquette Right Corner

47.5" W X 31" D X 52.75" H

St. Yardage: 9.25

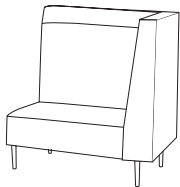

SIN #711-17

FREIGHT CLASS: 300
CUBIC FT: 53.6
SHIP WEIGHT: 115

Grade	1	2	3	4	5	6	7	8	9	10	L	LL
Zone 1	2730	2775	2958	3095	3232	3438	3621	3826	4009	4238	4786	5814
Zone 2	2771	2817	3002	3141	3280	3490	3675	3883	4069	4302	4858	5901
Zone 3	2812	2858	3047	3188	3329	3541	3730	3941	4129	4365	4930	5988

- Fully upholstered with double-needle trim on seat and back to reinforce seam
- Full height upholstered arm on right side.
- High back offers comfort and privacy in open collaborative areas
- Taut upholstered seat and back
- 8" aluminum cylinder legs with adjustable glides
- Freestanding or connects with other Eve seating units or tables
- Connects on right side facing of 5875
- Seat: 44.5"W X 20"D X 19.5"H

QS NOW

5875L Eve Banquette Left Corner

47.5" W X 31" D X 52.75" H

St. Yardage: 9.25

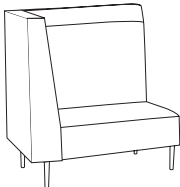

SIN #711-17

FREIGHT CLASS: 300
CUBIC FT: 53.6
SHIP WEIGHT: 115

Grade	1	2	3	4	5	6	7	8	9	10	L	LL
Zone 1	2730	2775	2958	3095	3232	3438	3621	3826	4009	4238	4786	5814
Zone 2	2771	2817	3002	3141	3280	3490	3675	3883	4069	4302	4858	5901
Zone 3	2812	2858	3047	3188	3329	3541	3730	3941	4129	4365	4930	5988

- Fully upholstered with double-needle trim on seat and back to reinforce seam
- Full height upholstered arm on left side.
- High back offers comfort and privacy in open collaborative areas
- Taut upholstered seat and back
- 8" aluminum cylinder legs with adjustable glides
- Freestanding or connects with other Eve seating units or tables
- Connects on left side facing of 5875
- Seat: 44.5"W X 20"D X 19.5"H

QS NOW

5821 Oval Table, Floating Laminate Top

42.5" W X 21.5" D X 22.5" H

St. Yardage: 1.75



SIN #711-11

FREIGHT CLASS: 175
CUBIC FT: 26
SHIP WEIGHT: 67

Grade	1	2	3	4	5	6	7	8	9	10	L	LL
Zone 1	1558	1585	1616	1643	1669	1706	1741	1777	1812	1858	1943	2143
Zone 2	1581	1609	1640	1668	1694	1732	1767	1804	1839	1886	1972	2175
Zone 3	1605	1633	1664	1692	1719	1757	1793	1830	1866	1914	2001	2207

- 1" thick thermally fused laminate tops
- Middle section of table is fully upholstered
- 2" anodized aluminum spacers create a floating top
- 8" aluminum cylinder legs with adjustable glides

QS NOW

5822 Oval Table, Laminate Top

42.5" W X 21.5" D X 20.5" H

St. Yardage: 1.75



SIN #711-11

EIGHT CLASS: 175
CUBIC FT: 26
SHIP WEIGHT: 66

Grade	1	2	3	4	5	6	7	8	9	10	L	LL
Zone 1	1521	1548	1579	1606	1633	1669	1705	1741	1776	1822	1906	2107
Zone 2	1544	1571	1603	1630	1657	1694	1731	1767	1803	1849	1935	2139
Zone 3	1567	1594	1626	1654	1682	1719	1756	1793	1829	1877	1963	2170

- 1" thick thermally fused laminate tops
- Fully upholstered sides
- 8" aluminum cylinder legs with adjustable glides

QS NOW

5826 Fully Upholstered Oval Tables



SIN #711-11

FREIGHT CLASS: 175
CUBIC FT: 26
SHIP WEIGHT: 47

QS NOW

42.5" W X 21.5" D X 19.5" H St. Yardage: 1.75

Grade	1	2	3	4	5	6	7	8	9	10	L	LL
Zone 1	1371	1398	1429	1456	1483	1519	1555	1591	1626	1672	1756	1957
Zone 2	1392	1419	1450	1478	1505	1542	1578	1615	1650	1697	1782	1986
Zone 3	1412	1440	1472	1500	1527	1565	1602	1639	1675	1722	1809	2016

- Fully Upholstered Table
- 8" aluminum cylinder legs with adjustable glides

5837 Round Table, Laminate Top

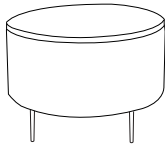

SIN #711-11

FREIGHT CLASS: 175
CUBIC FT: 42
SHIP WEIGHT: 130

QS NOW

36" D X 25.5" H St. Yardage: 3.5

Grade	1	2	3	4	5	6	7	8	9	10	L	LL
Zone 1	1867	1918	1978	2029	2079	2148	2215	2283	2350	2435	2597	2979
Zone 2	1895	1947	2008	2059	2110	2180	2248	2317	2385	2472	2636	3024
Zone 3	1923	1976	2037	2090	2141	2212	2281	2351	2421	2508	2675	3068

- 1" thick thermally fused laminate top
- 8" aluminum cylinder legs with adjustable glides
- Fully upholstered sides

5848 Round Ottoman/Table



SIN #711-11

FREIGHT CLASS: 125
CUBIC FT: 48.5
SHIP WEIGHT: 153

QS NOW

48" W X 48" D X 19" H St. Yardage: 3

Grade	1	2	3	4	5	6	7	8	9	10	L	LL
Zone 1	2287	2331	2389	2433	2477	2542	2600	2665	2724	2797	2971	3299
Zone 2	2321	2366	2425	2469	2514	2580	2639	2705	2765	2839	3016	3348
Zone 3	2356	2401	2461	2506	2551	2618	2678	2745	2806	2881	3060	3398

- Upholstered with 18" round thermally fused laminate "target" in center of top
- 8" brushed aluminum cylinder legs with adjustable glides

OPTION	PRICE	CODE
Tufted Top	300.00	TF

Eve Oasis

5811 Club Chair with Arms and Back Panel



SIN #711-17

FREIGHT CLASS: 250
CUBIC FT: 50
SHIP WEIGHT: 116

QS NOW

30" W X 33" D X 48" H St. Yardage: 7.25

Grade	1	2	3	4	5	6	7	8	9	10	L	LL
Zone 1	2515	2635	2776	2895	3014	3174	3334	3493	3653	3852	4231	5129
Zone 2	2553	2675	2818	2938	3059	3222	3384	3545	3708	3910	4294	5206
Zone 3	2590	2714	2859	2982	3104	3269	3434	3598	3763	3968	4358	5283

- Upholstered seat, back, arms and back panel
- 2" thick upholstered back panel adds privacy
- 8" brushed aluminum cylinder legs with adjustable glides
- Seat: 22" W X 20" D X 19.5" H

5812 Loveseat with Arms and Back Panel



FREIGHT CLASS: 250
CUBIC FT: 106
SHIP WEIGHT: 198

QS NOW

53" W X 33" D X 48" H St. Yardage: 9.5

Grade	1	2	3	4	5	6	7	8	9	10	L	LL
Zone 1	3225	3381	3565	3723	3879	4088	4296	4506	4715	4977	5474	6650
Zone 2	3273	3432	3618	3779	3937	4149	4360	4574	4786	5052	5556	6750
Zone 3	3322	3482	3672	3835	3995	4211	4425	4641	4856	5126	5638	6850

- Upholstered seat, back, arms and back panel
- 2" thick upholstered back panel adds privacy
- 8" brushed aluminum cylinder legs with adjustable glides
- Seat: 45" W X 20" D X 19.5" H

5813 Sofa with Arms and Back Panel

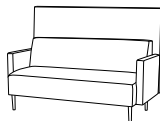

FREIGHT CLASS: 250
CUBIC FT: 106
SHIP WEIGHT: 270

QS NOW

76" W X 33" D X 48" H St. Yardage: 12.25

Grade	1	2	3	4	5	6	7	8	9	10	L	LL
Zone 1	3769	3973	4207	4410	4614	4883	5152	5422	5691	6029	6670	8186
Zone 2	3826	4033	4270	4476	4683	4956	5229	5503	5776	6119	6770	8309
Zone 3	3882	4092	4333	4542	4752	5029	5307	5585	5862	6210	6870	8432

- Upholstered seat, back, arms and back panel
- 2" thick upholstered back panel adds privacy
- 8" brushed aluminum cylinder legs with adjustable glides
- Seat: 66" W X 20" D X 19.5" H

5814 Armless Chair with Back Panel

22.5"W X 33"D X 48"H

St. Yardage: 5.5



FREIGHT CLASS: 300
CUBIC FT: 55
SHIP WEIGHT: 93

QS NOW

Grade	1	2	3	4	5	6	7	8	9	10	L	LL
Zone 1	1949	2040	2146	2236	2328	2448	2569	2691	2811	2962	3250	3931
Zone 2	1978	2071	2178	2270	2363	2485	2608	2731	2853	3006	3299	3990
Zone 3	2007	2101	2210	2303	2398	2521	2646	2772	2895	3051	3348	4049

- Upholstered seat, back and back panel
- 2" thick upholstered back panel adds privacy
- 8" brushed aluminum cylinder legs with adjustable glides
- Seat: 22"W X 20"D X 19.5"H

5815 Armless Loveseat with Back Panel

45.5"W X 33"D X 48"H

St. Yardage: 7.25

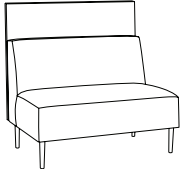

FREIGHT CLASS: 250
CUBIC FT: 88
SHIP WEIGHT: 169

QS NOW

Grade	1	2	3	4	5	6	7	8	9	10	L	LL
Zone 1	2593	2712	2851	2971	3092	3251	3409	3571	3730	3929	4309	5206
Zone 2	2632	2753	2894	3016	3138	3300	3460	3625	3786	3988	4374	5284
Zone 3	2671	2793	2937	3060	3185	3349	3511	3678	3842	4047	4438	5362

- Upholstered seat, back and back panel
- 2" thick upholstered back panel adds privacy
- 8" brushed aluminum cylinder legs with adjustable glides
- Seat: 45"W X 20"D X 19.5"H

5816 Armless Sofa with Back Panel

67"W X 33"D X 48"H

St. Yardage: 11

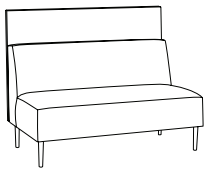

FREIGHT CLASS: 250
CUBIC FT: 106
WEIGHT: 183

QS NOW

Grade	1	2	3	4	5	6	7	8	9	10	L	LL
Zone 1	3154	3336	3547	3729	3910	4153	4396	4639	4879	5182	5758	7121
Zone 2	3201	3386	3600	3785	3969	4215	4462	4709	4952	5260	5844	7228
Zone 3	3249	3436	3653	3841	4027	4278	4528	4778	5025	5337	5931	7335

- Upholstered seat, back and back panel
- 2" thick upholstered back panel adds privacy
- 8" brushed aluminum cylinder legs with adjustable glides
- Seat: 66"W X 20"D X 19.5"H

Evette Child-Size Seating

Offers the same quality in construction as full size Eve lounge seating in a more youthful size. Mix with Eve adult-size seating to create comfortable and flexible seating arrangements for all ages in any size reception and lounge area.

Evette Design

Designed to be the perfect seating solution for elementary and middle school-aged children in youth areas in schools, libraries, doctor's offices, places of worship or anywhere child-size seating is necessary.

Evette Details

- Gang armless chairs with curved benches or tables
- Can be arranged as stand-alone seating
- Mix in oval tables, with or without laminate tops, or fully-upholstered cubes
- Add armless chairs with upholstered back panels arranged back-to-back or back-to-side to create an Oasis for private time
- Chairs with back panels must be connected for safety purposes



Evette

5834 Child Size Curved Bench

18" - 30" W X 24" D X 16.5" H St. Yardage: 1.5



SIN #711-17

FREIGHT CLASS: 150
CUBIC FT: 20
SHIP WEIGHT: 37

QS NOW

Grade	1	2	3	4	5	6	7	8	9	10	L	LL
Zone 1	1106	1131	1160	1185	1210	1243	1276	1309	1341	1383	1461	1647
Zone 2	1123	1148	1177	1203	1228	1262	1295	1329	1361	1404	1483	1672
Zone 3	1139	1165	1195	1221	1246	1280	1314	1348	1381	1424	1505	1696

- 8" brushed aluminum cylinder legs with adjustable glides
- Fully upholstered curved seat
- Freestanding or can be connected with other Evette units
- Seat 18"-30" W X 24" D X 16.5" H

5874 Child Size Armless Chair

18.5" W X 24" D X 28.5" H St. Yardage: 2



SIN #711-17

FREIGHT CLASS: 250
CUBIC FT: 20
SHIP WEIGHT: 36

QS NOW

Grade	1	2	3	4	5	6	7	8	9	10	L	LL
Zone 1	1313	1347	1385	1418	1451	1496	1539	1584	1627	1682	1786	2034
Zone 2	1333	1367	1406	1439	1473	1518	1562	1608	1651	1707	1813	2065
Zone 3	1352	1387	1427	1461	1495	1541	1585	1632	1676	1732	1840	2095

- Upholstered seat and back
- 8" brushed aluminum cylinder legs with adjustable glides
- Freestanding or can be connected with other Evette units
- Seat: 18.5"W X 16"D X 16.5"H

5883 Child Size Connecting/Freestanding Table

23.5" W X 23.5" D X 15.5" H St. Yardage: .75



SIN #711-11

FREIGHT CLASS: 150
CUBIC FT: 9
SHIP WEIGHT: 40

QS NOW

Grade	1	2	3	4	5	6	7	8	9	10	L	LL
Zone 1	1001	1012	1028	1039	1052	1068	1085	1102	1119	1139	1177	1272
Zone 2	1016	1027	1043	1055	1068	1084	1101	1119	1136	1156	1195	1291
Zone 3	1031	1042	1059	1070	1084	1100	1118	1135	1153	1173	1212	1310

- Thermal fused laminate top available in all Hyperwork finishes
- Upholstered sides
- Anodized, brushed aluminum cylinder legs with adjustable glides
- Freestanding or can be connected with other Evette units

5838-IF 30° Child-Size Curved Chair

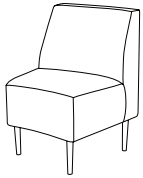

SIN #711-17

FREIGHT CLASS: 200
CUBIC FT:
SHIP WEIGHT:

St. Yardage: 3.75

Grade	1	2	3	4	5	6	7	8	9	10	L	LL
Zone 1	1510	1566	1640	1695	1751	1834	1908	1992	2066	2158	2381	2798
Zone 2	1533	1589	1665	1720	1777	1862	1937	2022	2097	2190	2417	2840
Zone 3	1555	1613	1689	1746	1804	1889	1965	2052	2128	2223	2452	2882

- Curved child-size chair
- Connect with Evette curved sofa, bench or linear units
- Fully upholstered seat and back with double needle stitching
- Brushed aluminum cylinder legs with adjustable glides

QS NOW

5868-IF 60° Child-Size Curved Loveseat

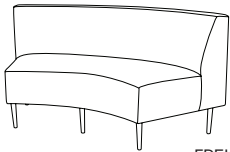

SIN #711-17

FREIGHT CLASS:
CUBIC FT:
SHIP WEIGHT:

St. Yardage: 7

Grade	1	2	3	4	5	6	7	8	9	10	L	LL
Zone 1	2341	2445	2583	2687	2791	2946	3085	3240	3379	3551	3966	4745
Zone 2	2379	2482	2622	2727	2833	2990	3131	3289	3430	3604	4025	4816
Zone 3	2411	2518	2660	2768	2875	3034	3178	3337	3480	3658	4085	4887

- Curved child-size sofa
- Connect with Evette curved chair, bench or linear units
- Fully upholstered seat and back with double needle stitching
- Brushed aluminum cylinder legs with adjustable glides

QS NOW

5881 Oval Table, Floating Laminate Top



SIN #711-11

FREIGHT CLASS: 175
CUBIC FT: 26
SHIP WEIGHT: 62

42.5" W X 21.5" D X 15.75" H St. Yardage: 1.75

Grade	1	2	3	4	5	6	7	8	9	10	L	LL
Zone 1	1276	1346	1426	1495	1564	1656	1748	1840	1932	2047	2266	2783
Zone 2	1295	1366	1447	1517	1587	1681	1774	1868	1961	2078	2300	2825
Zone 3	1314	1386	1469	1540	1611	1706	1800	1895	1990	2108	2334	2866

- 1" thick thermally fused laminate top, available in all Hyperwork finishes
- 2" anodized aluminum spacers create a floating top
- Fully upholstered base

QS NOW

5882 Oval Table, Laminate Top



SIN #711-11

FREIGHT CLASS: 175
CUBIC FT: 26
SHIP WEIGHT: 61

42.5" W X 21.5" D X 13.75" H St. Yardage: 1.75

Grade	1	2	3	4	5	6	7	8	9	10	L	LL
Zone 1	1246	1315	1396	1465	1534	1626	1718	1810	1902	2017	2236	2753
Zone 2	1265	1335	1417	1487	1557	1650	1744	1837	1931	2047	2270	2794
Zone 3	1283	1354	1438	1509	1580	1675	1770	1864	1959	2078	2303	2836

- 1" thick thermally fused laminate top, available in all Hyperwork finishes
- Fully upholstered base
- Black 3/4"H cylindrical non-marring floor glides

QS NOW

5886 Fully Upholstered Oval Table

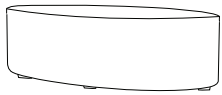

SIN #711-11

FREIGHT CLASS: 175
CUBIC FT: 25
SHIP WEIGHT: 59

42.5" W X 21.5" D X 12.75" H St. Yardage: 1.75

Grade	1	2	3	4	5	6	7	8	9	10	L	LL
Zone 1	1071	1141	1221	1290	1359	1451	1543	1635	1727	1842	2061	2578
Zone 2	1087	1158	1239	1309	1379	1473	1566	1660	1753	1870	2092	2617
Zone 3	1103	1175	1258	1329	1400	1495	1589	1684	1779	1897	2123	2655

- Fully upholstered
- Black 3/4"H cylindrical non-marring floor glides

QS NOW

Eve Oasis

5884 Child Size Chair with Back Panel



SIN #711-17

FREIGHT CLASS: 250
CUBIC FT: 56
SHIP WEIGHT: 59

18.5" W X 26" D X 43" H St. Yardage: 4.25

Grade	1	2	3	4	5	6	7	8	9	10	L	LL
Zone 1	1695	1766	1846	1918	1987	2081	2175	2268	2362	2479	2701	3227
Zone 2	1720	1792	1874	1947	2017	2112	2208	2302	2397	2516	2742	3275
Zone 3	1746	1819	1901	1976	2047	2143	2240	2336	2433	2553	2782	3324

- Upholstered seat, back and back panel
- 2" thick upholstered back panel adds privacy
- 8" brushed aluminum cylinder legs with adjustable glides
- Must be ganged for safety
- Seat: 18.5"W X 16"D X 16.5"H

QS NOW

FINISH SELECTION

ASPEN **AP** | BLACK **BLK** | BOARDWALK **BW** | DRIFTWOOD **DW** | ESPRESSO **ESP** | HONEY CHERRY **HCY** | MAHOGANY **MAH** | MOAB **MOB** | NATURAL **FM** | ROUGE MAHOGANY **RM** | WINDSOR CHERRY **WC** | SHORELINE **SL** |

SIN 711-17 **ACCOMPANY WOOD**

CONTEMPORARY

Sit Side-By-Side in Comfort

Generous armrests separate and create private space for each individual. Especially suited for public areas and waiting rooms, the gentle curves and substantial visual scale of **Accompany** creates an impression of comfort, encouraging users to relax.



Accompany Details

- Firm, ergonomically correct cushioning ensures comfort.
- Taut-upholstered for smooth, contemporary appearance
- Two-color combination - Unit invoiced at the highest fabric price grade featured on unit (Not available for QS or NOW)

Power Option

Power modules can be installed in arm or in front. See page 135.



5903 Three Seat Lounge and 5901 Chair

Accompany Wood

5901 Lounge Chair

32.5" W X 29" D X 31" H

St. Yardage: 5

Seat & Back Ydg: 3

Arms Ydg: 3

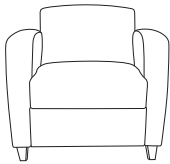

SIN #711-17

FREIGHT CLASS: 250
CUBIC FT: 29
SHIP WEIGHT: 79

Grade	1	2	3	4	5	6	7	8	9	10	L	LL
Zone 1	1440	1645	1827	1926	2081	2142	2283	2394	2550	2745	3764	3991
Zone 2	1462	1670	1854	1955	2112	2174	2317	2430	2588	2786	3820	4051
Zone 3	1483	1694	1882	1984	2143	2206	2351	2466	2627	2827	3877	4111

- Tapered arm design
- Adjustable leveling glides
- Extra-thick seat foam
- No-sag spring seat/back suspensions
- Hardwood frame
- Optional tablets are located on outside of arm, specify left or right facing and indicate finish
- Seat: 21"W x 19"D x 19"H

OPTION	PRICE	CODE
Softer Seat Foam-Chair	16.00	SF
Genesis Tablet	514.00	GT
Pivoting Tablet	514.00	LT
Double Pivot Tablet	689.00	DT
4 Accompany Locking Casters	85.00	AC

QS NOW

5902 Two Seat Lounge

59.75" W X 29" D X 31" H

St. Yardage: 9

Seat & Back Ydg: 6

Arms Ydg: 4.5

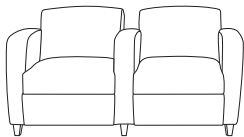

SIN #711-17

FREIGHT CLASS: 250
CUBIC FT: 42
SHIP WEIGHT: 146

Grade	1	2	3	4	5	6	7	8	9	10	L	LL
Zone 1	2434	2782	3079	3185	3272	3459	3643	3783	4076	4345	5442	6079
Zone 2	2471	2824	3125	3233	3321	3511	3698	3840	4137	4410	5524	6170
Zone 3	2507	2865	3171	3281	3370	3563	3752	3896	4198	4475	5605	6261

- Tapered arm design
- Adjustable leveling glides
- Extra-thick seat foam
- No-sag spring seat/back suspensions
- Hardwood frame
- Optional tablets are located on outside of end arms only, specify left or right facing and indicate finish
- Each seat: 21"W x 19"D x 19"H

OPTION	PRICE	CODE
Softer Seat Foam-Loveseat	32.00	SF
Genesis Tablet	514.00	GT
Pivoting Tablet	514.00	LT
Double Pivot Tablet	689.00	DT

QS NOW

5903 Three Seat Lounge

86.5" W X 29" D X 31" H

St. Yardage: 12.5

Seat & Back Ydg: 8

Arms Ydg: 5.5

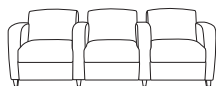

SIN #711-17

FREIGHT CLASS: 250
CUBIC FT: 66
SHIP WEIGHT: 178

Grade	1	2	3	4	5	6	7	8	9	10	L	LL
Zone 1	3402	3906	4360	4572	4750	4946	5090	5694	6068	6537	8283	9644
Zone 2	3453	3965	4425	4641	4821	5020	5166	5779	6159	6635	8407	9789
Zone 3	3504	4023	4491	4709	4893	5094	5243	5865	6250	6733	8531	9933

- Tapered arm design
- Adjustable leveling glides
- Extra-thick seat foam
- No-sag spring seat/back suspensions
- Hardwood frame
- Optional tablets are located on outside of end arms only, specify left or right facing and indicate finish
- Each seat: 21"W x 19"D x 19"H

OPTION	PRICE	CODE
Softer Seat Foam-Sofa	48.00	SF
Genesis Tablet	514.00	GT
Pivoting Tablet	514.00	LT
Double Pivot Tablet	689.00	DT

QS NOW

5965-OF 60° Outside Facing Loveseat

70" W X 32.5" D X 31" H

St. Yardage: 7

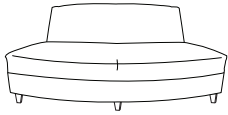

SIN #711-17

FREIGHT CLASS: 250
CUBIC FT: 74
SHIP WEIGHT: 125

QS NOW

Grade	1	2	3	4	5	6	7	8	9	10	L	LL
Zone 1	2360	2480	2622	2818	2962	3157	3288	3463	3736	3979	4111	4552
Zone 2	2395	2517	2661	2860	3006	3204	3337	3515	3792	4039	4173	4620
Zone 3	2431	2554	2701	2903	3051	3252	3387	3567	3848	4098	4234	4689

- Extra-thick high density foam
- No-sag sinuous wire spring suspension
- Use with other 60° or 30° curved units to form curves in reception layout

- Can also be used with Accompany armless chair
- Seat: 52.5-70"W x 19"D x 19"H

OPTION	PRICE	CODE
Softer Seat Foam-Loveseat	32.00	SF

5965-IF 60° Inside Facing Loveseat

70" W X 32.5" D X 31" H

St. Yardage: 7.75

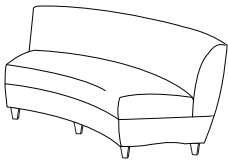

SIN #711-17

FREIGHT CLASS: 250
CUBIC FT: 74
SHIP WEIGHT: 121

QS NOW

Grade	1	2	3	4	5	6	7	8	9	10	L	LL
Zone 1	2360	2480	2622	2818	2962	3157	3288	3463	3736	3979	4111	4552
Zone 2	2395	2517	2661	2860	3006	3204	3337	3515	3792	4039	4173	4620
Zone 3	2431	2554	2701	2903	3051	3252	3387	3567	3848	4098	4234	4689

- Extra-thick high density foam
- No-sag sinuous wire spring suspension
- Use with other 60° or 30° curved units to form curves in reception layout

- Can also be used with Accompany armless chair
- Seat: 43-63"W x 19"D x 19"H

OPTION	PRICE	CODE
Softer Seat Foam-Loveseat	32.00	SF

5935-OF 30° Outside Facing Chair

38" W X 31" D X 31" H

St. Yardage: 4

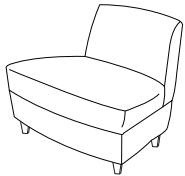

SIN #711-17

FREIGHT CLASS: 250
CUBIC FT: 31
SHIP WEIGHT: 65

QS NOW

Grade	1	2	3	4	5	6	7	8	9	10	L	LL
Zone 1	1548	1610	1683	1785	1861	1959	2056	2160	2259	2384	2452	2838
Zone 2	1571	1634	1708	1812	1889	1988	2087	2192	2293	2420	2489	2881
Zone 3	1594	1658	1733	1839	1917	2018	2118	2225	2327	2456	2526	2923

- Extra-thick high density foam
- No-sag sinuous wire spring suspension
- Use with other 60° or 30° curved units to form curves in reception layout

- Can also be used with Accompany armless chair
- Seat: 27.5-34.5"W x 19"D x 19"H

OPTION	PRICE	CODE
Softer Seat Foam-Chair	16.00	SF

5935-IF 30° Inside Facing Chair

38" W X 31" D X 31" H

St. Yardage: 4.75

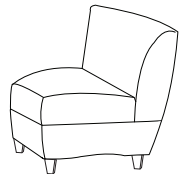

SIN #711-17

FREIGHT CLASS: 250
CUBIC FT: 31
SHIP WEIGHT: 60

QS NOW

Grade	1	2	3	4	5	6	7	8	9	10	L	LL
Zone 1	1548	1610	1683	1785	1861	1959	2056	2160	2259	2384	2452	2838
Zone 2	1571	1634	1708	1812	1889	1988	2087	2192	2293	2420	2489	2881
Zone 3	1594	1658	1733	1839	1917	2018	2118	2225	2327	2456	2526	2923

- Extra-thick high density foam
- No-sag sinuous wire spring suspension
- Use with other 60° or 30° curved units to form curves in reception layout

- Can also be used with Accompany armless chair
- Seat: 21.25-30.75"W x 19"D x 19"H

OPTION	PRICE	CODE
Softer Seat Foam-Chair	16.00	SF

5948 Round Table/Ottoman with wood legs

48"W X 48"D X 14.5"H

St. Yardage: 3

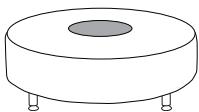

SIN #711-17

FREIGHT CLASS: 175
CUBIC FT: 41.5
SHIP WEIGHT: 135

QS NOW

Grade	1	2	3	4	5	6	7	8	9	10	L	LL
Zone 1	2100	2143	2201	2246	2289	2355	2413	2478	2537	2609	2784	3111
Zone 2	2132	2175	2234	2280	2323	2390	2449	2515	2575	2648	2826	3158
Zone 3	2163	2207	2267	2313	2358	2426	2485	2552	2613	2687	2868	3204

- Upholstered with 18" round target table in center of top

OPTION	PRICE	CODE
Tufted Top	300.00	TF

FINISH SELECTION

ASPEN AP | BLACK BLK | BOARDWALK BW | DRIFTWOOD DW | ESPRESSO ESP |
 HONEY CHERRY HCY | MAHOGANY MAH | MOAB MOB | NATURAL FM | ROUGE
 MAHOGANY RM | WINDSOR CHERRY WC | SHORELINE SL |

SIN VARIOUS ACCOMPANY WOOD

CONTEMPORARY

5924 Connecting/Freestanding Table

23" W X 27" D X 11.5" H St. Yardage: 1.5

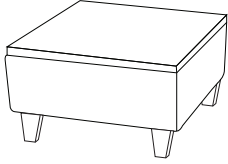

FREIGHT CLASS: 175
 CUBIC FT: 10
 SHIP WEIGHT: 49

SIN #711-11

Grade	1	2	3	4	5	6	7	8	9	10	L	LL
Zone 1	1118	1141	1169	1197	1224	1258	1292	1327	1360	1402	1457	1675
Zone 2	1135	1158	1187	1215	1242	1277	1311	1347	1380	1423	1479	1700
Zone 3	1152	1175	1204	1233	1261	1296	1331	1367	1401	1444	1501	1725

- Thermally fused laminate top available in all Hyperwork finishes
- Contemporary taut upholstered sides
- Use with Accompany curved units and armless chair

Top Finish Options: Natural Maple (FM), Windsor Cherry (WC), Mahogany (M), Graphite (GP), Black (E), Espresso (X), Boardwalk (BW), Driftwood (DW), Shoreline (SL)

Quick Ship Finishes: Windsor Cherry, Natural Maple, Aspen, Black & Mahogany

QS NOW

5925 Wedge Table

36" W X 28" D X 11.5" H St. Yardage: 1.5

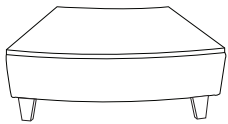

FREIGHT CLASS: 175
 CUBIC FT: 17.5
 SHIP WEIGHT: 62

SIN #711-11

Grade	1	2	3	4	5	6	7	8	9	10	L	LL
Zone 1	1152	1175	1202	1232	1259	1292	1327	1361	1394	1438	1492	1633
Zone 2	1169	1193	1220	1250	1278	1311	1347	1381	1415	1460	1514	1657
Zone 3	1187	1210	1238	1269	1297	1331	1367	1402	1436	1481	1537	1682

- Thermally fused laminate top available in all Hyperwork finishes
- Contemporary taut upholstered sides
- Use with Accompany curved units to form curves in reception layouts
- Can also be used with Accompany armless chair

Top Finish Options: Natural Maple (FM), Windsor Cherry (WC), Mahogany (M), Graphite (GP), Aspen (AP), Black (E), Espresso (X), Boardwalk (BW), Driftwood (DW), Shoreline (SL)

Quick Ship Finishes: Windsor Cherry, Natural Maple, Aspen, Black & Mahogany

QS NOW

5904 Armless Lounge Chair

22" W X 29" D X 31" H St. Yardage: 3.5

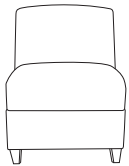

FREIGHT CLASS: 250
 CUBIC FT: 19
 SHIP WEIGHT: 43

SIN #711-17

Grade	1	2	3	4	5	6	7	8	9	10	L	LL
Zone 1	1005	1084	1167	1243	1317	1417	1455	1617	1717	1840	2206	2524
Zone 2	1020	1100	1185	1262	1337	1438	1477	1641	1743	1868	2239	2562
Zone 3	1035	1117	1202	1280	1357	1460	1499	1666	1769	1895	2272	2600

- Adjustable leveling glides
- Extra-thick seat foam
- No-sag spring seat/back suspensions
- Hardwood frame
- Seat: 22"W x 19"D x 19"H

OPTION	PRICE	CODE
Softer Seat Foam-Chair	16.00	SF
CASTER OPTION	PRICE	CODE
4 Accompany Locking Casters	85.00	AC

QS NOW

5905 Loveseat

54.5" W X 29" D X 31" H St. Yardage: 8.5 Seat & Back Ydg: 6 Arms Ydg: 3

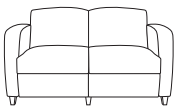

FREIGHT CLASS: 250
 CUBIC FT: 41
 SHIP WEIGHT: 113

SIN #711-17

Grade	1	2	3	4	5	6	7	8	9	10	L	LL
Zone 1	2050	2251	2452	2641	2829	3079	3175	3578	3826	4139	5049	5435
Zone 2	2081	2285	2489	2681	2871	3125	3223	3632	3883	4201	5125	5517
Zone 3	2112	2319	2526	2720	2914	3171	3270	3685	3941	4263	5200	5598

- Tapered arm design
- Adjustable leveling glides
- Extra-thick seat foam
- No-sag spring seat/back suspensions
- Hardwood frame
- Optional tablets are located on outside of arm, specify left or right facing and indicate finish
- Seat: 43.5"W x 19"D x 19"H

OPTION	PRICE	CODE
Softer Seat Foam-Loveseat	32.00	SF
Genesis Tablet	514.00	GT
Pivoting Tablet	514.00	LT
Double Pivot Tablet	689.00	DT

QS NOW

5906 Sofa

76" W X 29" D X 31" H St. Yardage: 10.5 Seat & Back Ydg: 8.5 Arms Ydg: 3



FREIGHT CLASS: 250
 CUBIC FT: 66
 SHIP WEIGHT: 145

SIN #711-17

Grade	1	2	3	4	5	6	7	8	9	10	L	LL
Zone 1	2880	3153	3428	3680	3934	4271	4401	4945	5282	5702	6933	7479
Zone 2	2923	3200	3479	3735	3993	4335	4467	5019	5361	5788	7037	7591
Zone 3	2966	3248	3531	3790	4052	4399	4533	5093	5440	5873	7141	7703

- Adjustable leveling glides
- Tapered arm design
- Extra-thick seat foam
- Hardwood frame
- No-sag spring seat/back suspensions
- Seat: 65"W x 19"D x 19"H

OPTION	PRICE	CODE
Softer Seat Foam-Sofa	48.00	SF
Genesis Tablet	514.00	GT
Pivoting Tablet	514.00	LT
Double Pivot Tablet	689.00	DT

QS NOW

ACCOMPANY MODULAR SIN 711-17

CONTEMPORARY

Sit Side-By-Side in Comfort

Generous armrests separate and create private space for each individual. Especially suited for public areas and waiting rooms: the gentle curves and substantial visual scale of **Accompany** creates an impression of comfort, encouraging users to relax.

Two-Color Combinations: Unit invoiced at the highest fabric price grade featured on unit.

MODULAR ORDER DETAIL:

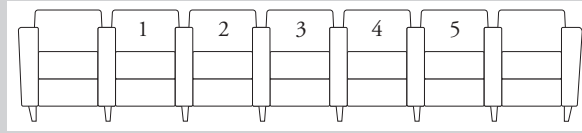

This Accompany Modular order would consist of the following model numbers:

- (1) 5913 Left End Unit
- (1) 5914 Right End Unit
- (5) 5911 Center Seats
- (6) 5912 Center Arms

Accompany Modular

5911 Center Seat, Connects with 5912 Center Arms

22" W X 29" D X 28" H

St. Yardage: 3

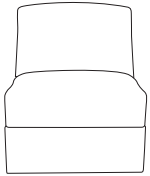

SIN #711-17

FREIGHT CLASS: 250
CUBIC FT: 20
SHIP WEIGHT: 37

Grade	1	2	3	4	5	6	7	8	9	10	L	LL
Zone 1	672	776	881	945	1032	1065	1206	1293	1402	1610	1906	2101
Zone 2	682	788	894	959	1047	1081	1224	1312	1423	1634	1935	2133
Zone 3	692	799	907	973	1063	1097	1242	1332	1444	1658	1963	2164

- Extra-thick seat foam
- No-sag spring seat/back suspensions
- Hardwood frame
- Requires easy bolt-on assembly
- Seat: 21"W x 19"D x 19"H
- Unit height will be 31"H when connected

OPTION	PRICE	CODE
Softer Seat Foam-Chair	16.00	SF

QS NOW

5912 Center Arm

6" W X 29" D X 25.5" H

St. Yardage: 1.75

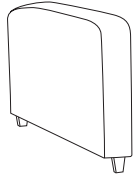

SIN #711-17

FREIGHT CLASS: 70
CUBIC FT: 4.3
SHIP WEIGHT: 20

Grade	1	2	3	4	5	6	7	8	9	10	L	LL
Zone 1	365	422	471	501	545	562	633	676	731	834	1043	1125
Zone 2	370	428	478	509	553	570	642	686	742	847	1059	1142
Zone 3	376	435	485	516	561	579	652	696	753	859	1074	1159

- Wood legs in finishes listed above
- Hardwood frame
- Requires easy bolt-on assembly

QS NOW

5913 Left Arm Unit, Ships with Arm/Seat Assembled

26.5" W X 29" D X 31" H

St. Yardage: 4.75

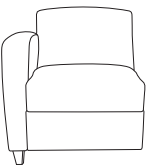

SIN #711-17

FREIGHT CLASS: 250
CUBIC FT: 16
SHIP WEIGHT: 55

Grade	1	2	3	4	5	6	7	8	9	10	L	LL
Zone 1	1057	1224	1374	1466	1596	1647	1859	1988	2152	2462	2742	3101
Zone 2	1073	1242	1395	1488	1620	1672	1887	2018	2184	2499	2783	3148
Zone 3	1089	1261	1415	1510	1644	1696	1915	2048	2217	2536	2824	3194

- Tapered arm design
- Wood legs in finishes listed above
- Extra-thick seat foam
- No-sag spring seat/back suspensions
- Hardwood frame
- Requires easy bolt-on assembly
- Seat: 21"W x 19"D x 19"H

OPTION	PRICE	CODE
Softer Seat Foam-Chair	16.00	SF

QS NOW

5914 Right Arm Unit, Ships with Arm/Seat Assembled

26.5" W X 29" D X 31" H

St. Yardage: 4.75

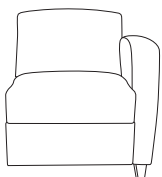

SIN #711-17

FREIGHT CLASS: 250
CUBIC FT: 16
SHIP WEIGHT: 55

Grade	1	2	3	4	5	6	7	8	9	10	L	LL
Zone 1	1057	1224	1374	1466	1596	1647	1859	1988	2152	2462	2742	3101
Zone 2	1073	1242	1395	1488	1620	1672	1887	2018	2184	2499	2783	3148
Zone 3	1089	1261	1415	1510	1644	1696	1915	2048	2217	2536	2824	3194

- Tapered arm design
- Wood legs in finishes listed above
- Extra-thick seat foam
- No-sag spring seat/back suspensions
- Hardwood frame
- Requires easy bolt-on assembly
- Seat: 21"W x 19"D x 19"H

OPTION	PRICE	CODE
Softer Seat Foam-Chair	16.00	SF

QS NOW

FINISH SELECTION

ASPEN **AP** | BLACK **BLK** | BOARDWALK **BW** | DRIFTWOOD **DW** | ESPRESSO **ESP** |
 HONEY CHERRY **HCY** | MAHOGANY **MAH** | MOAB **MOB** | NATURAL **FM** |
 ROUGE MAHOGANY **RM** | WINDSOR CHERRY **WC** | SHORELINE **SL** |

SIN VARIOUS ACCOMPANY MODULAR

CONTEMPORARY

5904CL Armless Chair-Connects Left Side Facing

22" W X 29" D X 31" H

St. Yardage: 3.5

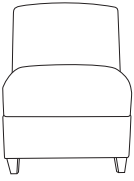

SIN #711-17

FREIGHT CLASS: 250
 CUBIC FT: 19
 SHIP WEIGHT: 43

Grade	1	2	3	4	5	6	7	8	9	10	L	LL
Zone 1	1106	1192	1284	1367	1449	1559	1601	1779	1889	2024	2427	2776
Zone 2	1123	1210	1303	1388	1471	1582	1625	1806	1917	2054	2463	2818
Zone 3	1139	1228	1323	1408	1492	1606	1649	1832	1946	2085	2500	2859

- 5904CL connectable on left side facing
- Requires easy bolt-on assembly
- Seat 22"W x 19"D x 16"H

OPTION	PRICE	CODE
Softer Seat Foam-Chair	16.00	SF

QS NOW

5904CR Armless Chair-Connects Right Side Facing

22" W X 29" D X 31" H

St. Yardage: 3.5

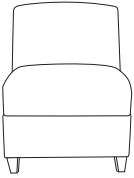

SIN #711-17

FREIGHT CLASS: 250
 CUBIC FT: 19
 SHIP WEIGHT: 43

Grade	1	2	3	4	5	6	7	8	9	10	L	LL
Zone 1	1106	1192	1284	1367	1449	1559	1601	1779	1889	2024	2427	2776
Zone 2	1123	1210	1303	1388	1471	1582	1625	1806	1917	2054	2463	2818
Zone 3	1139	1228	1323	1408	1492	1606	1649	1832	1946	2085	2500	2859

- 5904CR connectable on right side facing
- Requires easy bolt-on assembly
- Seat 22"W x 19"D x 16"H

OPTION	PRICE	CODE
Softer Seat Foam-Chair	16.00	SF

QS NOW

5904CLR Armless Chair-Connects Both Sides

22" W X 29" D X 31" H

St. Yardage: 3.5

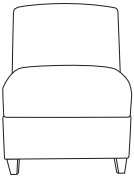

SIN #711-17

FREIGHT CLASS: 250
 CUBIC FT: 19
 SHIP WEIGHT: 43

Grade	1	2	3	4	5	6	7	8	9	10	L	LL
Zone 1	1106	1192	1284	1367	1449	1559	1601	1779	1889	2024	2427	2776
Zone 2	1123	1210	1303	1388	1471	1582	1625	1806	1917	2054	2463	2818
Zone 3	1139	1228	1323	1408	1492	1606	1649	1832	1946	2085	2500	2859

- 5904CLR connectable on both sides
- Requires easy bolt-on assembly
- Seat 22"W x 19"D x 16"H

OPTION	PRICE	CODE
Softer Seat Foam-Chair	16.00	SF

QS NOW

Sit Side-By-Side in Comfort

Generous armrests separate and create private space for each individual. Especially suited for public areas and waiting rooms, the gentle curves and substantial visual scale of Accompany creates an impression of comfort, encouraging users to relax.

Accompany Metal Details

- Brushed aluminum cylinder legs with chrome leg levelers are 4.75" high
- Two-Color Combinations: Unit invoiced at the highest fabric price grade featured on unit

Power Option

Power modules can be installed in arms or in front. See page 135.



Accompany Metal Leg

5901MET Lounge Chair

32.5" W X 29" D X 32.5" H St. Yardage: 5 Seat & Back Ydg: 3 Arms Ydg: 3

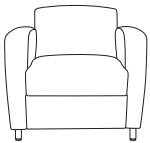

FREIGHT CLASS: 250
CUBIC FT: 31
SHIP WEIGHT: 81

SIN #711-17

QS NOW

Grade	1	2	3	4	5	6	7	8	9	10	L	LL
Zone 1	1511	1707	1882	1999	2153	2215	2356	2466	2623	2817	3837	4064
Zone 2	1534	1733	1910	2029	2185	2248	2391	2503	2662	2859	3895	4125
Zone 3	1556	1758	1938	2059	2218	2281	2427	2540	2702	2902	3952	4186

- Chrome leg levelers
- Extra-thick, high-density cushions
- No-sag sinuous wire spring seat and back suspensions
- Optional tablets are located on outside of arm, specify left or right facing and indicate finish
- Seat: 21"W x 19"D x 19"H

OPTION	PRICE	CODE
Softer Seat Foam-Chair	16.00	SF
Genesis Tablet	514.00	GT
Pivoting Tablet	514.00	LT
Double Pivot Tablet	689.00	DT

5902MET Two-Seat Lounge

59.75" W X 29" D X 32.5" H St. Yardage: 9 Seat & Back Ydg: 6 Arms Ydg: 4.5

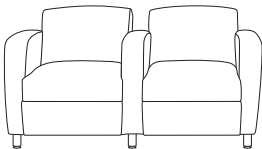

FREIGHT CLASS: 250
CUBIC FT: 51
SHIP WEIGHT: 148

SIN #711-17

QS NOW

Grade	1	2	3	4	5	6	7	8	9	10	L	LL
Zone 1	2532	2864	3147	3369	3638	3740	3952	4173	4441	4778	5874	6510
Zone 2	2570	2907	3194	3420	3693	3796	4011	4236	4508	4850	5962	6608
Zone 3	2608	2950	3241	3470	3747	3852	4071	4298	4574	4921	6050	6705

- Chrome leg levelers
- Extra-thick, high-density cushions
- No-sag sinuous wire spring seat and back suspensions
- Center arm separates seats
- Optional tablets are located on outside of end arms only, specify left or right facing and indicate finish
- Each seat: 21"W x 19"D x 19"H

OPTION	PRICE	CODE
Softer Seat Foam-Loveseat	32.00	SF
Genesis Tablet	514.00	GT
Pivoting Tablet	514.00	LT
Double Pivot Tablet	689.00	DT

5903MET Three-Seat Lounge

86.5" W X 29" D X 32.5" H St. Yardage: 12.5 Seat & Back Ydg: 8 Arms Ydg: 5.5

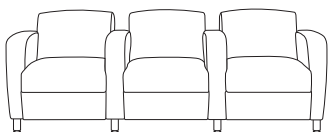

FREIGHT CLASS: 250
CUBIC FT: 68
SHIP WEIGHT: 178

QS NOW

Grade	1	2	3	4	5	6	7	8	9	10	L	LL
Zone 1	3536	4015	4447	4705	5079	5339	5826	6202	6669	7558	9304	9664
Zone 2	3589	4075	4514	4776	5155	5419	5913	6295	6769	7671	9444	9809
Zone 3	3642	4135	4580	4846	5231	5499	6001	6388	6869	7785	9583	9954

- Chrome leg levelers
- Extra-thick, high-density cushions
- No-sag sinuous wire spring seat and back suspensions
- Center arms separate seats
- Optional tablets are located on outside of end arms only, specify left or right facing and indicate finish
- Each seat: 21"W x 19"D x 19"H

OPTION	PRICE	CODE
Softer Seat Foam-Sofa	48.00	SF
Genesis Tablet	514.00	GT
Pivoting Tablet	514.00	LT
Double Pivot Tablet	689.00	DT

5965MET-OF 60° Curved Loveseat, Outside Facing

70" W X 32.5" D X 32.5" H

St. Yardage: 7

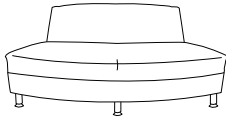

FREIGHT CLASS: 250
CUBIC FT: 74
SHIP WEIGHT: 125

QS NOW

SIN #711-17

Grade	1	2	3	4	5	6	7	8	9	10	L	LL
Zone 1	2360	2480	2622	2818	2962	3157	3288	3463	3736	3979	4111	4552
Zone 2	2395	2517	2661	2860	3006	3204	3337	3515	3792	4039	4173	4620
Zone 3	2431	2554	2701	2903	3051	3252	3387	3567	3848	4098	4234	4689

- Extra-thick high density cushions
- No-sag sinuous wire spring suspension
- Brushed aluminum cylinder legs with chrome leg levelers
- Connections done as a quote
- Use with other 60° or 30° curved units to form curves in reception layout
- Can also be used with Accompany Metal armless chair
- Seat: 52.5-70" W X 20" D X 19" H

OPTION	PRICE	CODE
Softer Seat Foam-Loveseat	32.00	SF

5965MET-IF 60° Curved Loveseat, Inside Facing

70" W X 32.5" D X 32.5" H

St. Yardage: 7.75

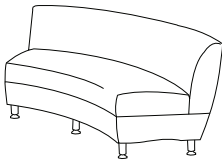

FREIGHT CLASS: 250
CUBIC FT: 74
SHIP WEIGHT: 120

QS NOW

SIN #711-17

Grade	1	2	3	4	5	6	7	8	9	10	L	LL
Zone 1	2360	2480	2622	2818	2962	3157	3288	3463	3736	3979	4111	4552
Zone 2	2395	2517	2661	2860	3006	3204	3337	3515	3792	4039	4173	4620
Zone 3	2431	2554	2701	2903	3051	3252	3387	3567	3848	4098	4234	4689

- Extra-thick high density cushions
- No-sag sinuous wire spring suspension
- Brushed aluminum cylinder legs with chrome leg levelers
- Connections done as a quote
- Use with other 60° or 30° curved units to form curves in reception layout
- Can also be used with Accompany Metal armless chair
- Seat: 43-63" W X 20" D X 19" H

OPTION	PRICE	CODE
Softer Seat Foam-Loveseat	32.00	SF

5935MET-OF 30° Curved Chair, Outside Facing

38" W X 31" D X 32.5" H

St. Yardage: 4

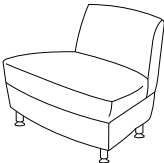

FREIGHT CLASS: 250
CUBIC FT: 31
SHIP WEIGHT: 65

QS NOW

SIN #711-17

Grade	1	2	3	4	5	6	7	8	9	10	L	LL
Zone 1	1548	1610	1683	1785	1861	1959	2056	2160	2259	2384	2452	2838
Zone 2	1571	1634	1708	1812	1889	1988	2087	2192	2293	2420	2489	2881
Zone 3	1594	1658	1733	1839	1917	2018	2118	2225	2327	2456	2526	2923

- Extra-thick high density cushions
- No-sag sinuous wire spring suspension
- Brushed aluminum cylinder legs with chrome leg levelers
- Can also be used with Accompany Metal armless chair
- Use with other 60° or 30° curved units to form curves in reception layout
- Connections done as a quote
- Seat: 27 5-34.5" W X 20" D X 19" H

OPTION	PRICE	CODE
Softer Seat Foam-Chair	16.00	SF

5935MET-IF 30° Curved Chair, Inside Facing

38" W X 31" D X 32.5" H

St. Yardage: 4.75

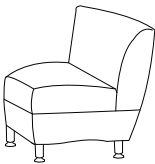

FREIGHT CLASS: 250
CUBIC FT: 31
SHIP WEIGHT: 60

QS NOW

SIN #711-17

Grade	1	2	3	4	5	6	7	8	9	10	L	LL
Zone 1	1548	1610	1683	1785	1861	1959	2056	2160	2259	2384	2452	2838
Zone 2	1571	1634	1708	1812	1889	1988	2087	2192	2293	2420	2489	2881
Zone 3	1594	1658	1733	1839	1917	2018	2118	2225	2327	2456	2526	2923

- Extra-thick high density cushions
- No-sag sinuous wire spring suspension
- Brushed aluminum cylinder legs with chrome leg levelers
- Use with other 60° or 30° curved units to form curves in reception layout
- Can also be used with Accompany Metal armless chair
- Connections done as a quote
- Seat: 21.25-30.75" W X 20" D X 19" H

OPTION	PRICE	CODE
Softer Seat Foam-Chair	16.00	SF

5924MET Connecting/Freestanding Table

23" W X 27" D X 13" H

St. Yardage: 1.5

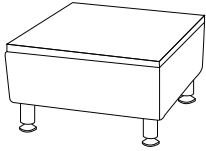

FREIGHT CLASS: 175
CUBIC FT: 10
SHIP WEIGHT: 49

SIN #711-11

Grade	1	2	3	4	5	6	7	8	9	10	L	LL
Zone 1	1118	1141	1169	1197	1224	1258	1292	1327	1360	1402	1457	1675
Zone 2	1135	1158	1187	1215	1242	1277	1311	1347	1380	1423	1479	1700
Zone 3	1152	1175	1204	1233	1261	1296	1331	1367	1401	1444	1501	1725

- Thermally fused laminate top available in finishes listed
- Contemporary taut upholstered sides
- Bushed aluminum cylinder legs with chrome leg levelers

Top Finish Options: Natural Maple (FM), Windsor Cherry (WC), Mahogany (M), Graphite (GP), Black (E), Espresso (X), Boardwalk (BW), Driftwood (DW), Shoreline (SL)

Quick Ship Finishes: Windsor Cherry, Natural Maple, Aspen, Black & Mahogany

QS NOW

5925MET Wedge Table

36" W X 28" D X 13" H

St. Yardage: 1.5

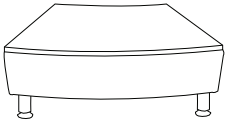

SIN #711-11

FREIGHT CLASS: 175
CUBIC FT: 17.5
SHIP WEIGHT: 62

Grade	1	2	3	4	5	6	7	8	9	10	L	LL
Zone 1	1152	1175	1202	1232	1259	1292	1327	1361	1394	1438	1492	1633
Zone 2	1169	1193	1220	1250	1278	1311	1347	1381	1415	1460	1514	1657
Zone 3	1187	1210	1238	1269	1297	1331	1367	1402	1436	1481	1537	1682

- Thermally fused laminate top available in finishes listed
- Contemporary taut upholstered sides
- Bushed aluminum cylinder legs with chrome leg levelers
- Use with Accompany Metal curved units to form curves in reception layouts

Top Finish Options: Natural Maple (FM), Windsor Cherry (WC), Mahogany (M), Graphite (GP), Black (E), Espresso (X), Boardwalk (BW), Driftwood (DW), Shoreline (SL)

Quick Ship Finishes: Windsor Cherry, Natural Maple, Aspen, Black & Mahogany

QS NOW

5904MET Armless Chair

22" W X 29" D X 32.5" H

St. Yardage: 3.5

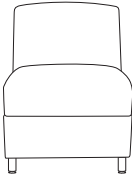

SIN #711-17

FREIGHT CLASS: 250
CUBIC FT: 20
SHIP WEIGHT: 44

Grade	1	2	3	4	5	6	7	8	9	10	L	LL
Zone 1	1099	1176	1253	1337	1412	1511	1550	1711	1810	1934	2244	2732
Zone 2	1115	1194	1272	1357	1433	1534	1573	1737	1837	1963	2278	2773
Zone 3	1132	1211	1291	1377	1454	1556	1597	1762	1864	1992	2311	2814

- Chrome leg levelers
- Extra-thick, high-density cushions
- No-sag sinuous wire spring seat and back suspensions
- Seat: 21" W x 20" D x 19" H

OPTION	PRICE	CODE
Softer Seat Foam-Chair	16.00	SF

QS NOW

5905MET Loveseat

54.5" W X 29" D X 32.5" H

St. Yardage: 8.5

Seat & Back Ydg: 6

Arms Ydg: 3

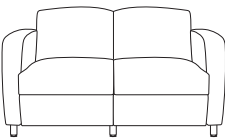

SIN #711-17

FREIGHT CLASS: 250
CUBIC FT: 41
SHIP WEIGHT: 123

Grade	1	2	3	4	5	6	7	8	9	10	L	LL
Zone 1	2165	2357	2549	2756	2944	3193	3289	3694	3942	4254	5020	5905
Zone 2	2197	2392	2587	2797	2988	3241	3338	3749	4001	4318	5095	5994
Zone 3	2230	2428	2625	2839	3032	3289	3388	3805	4060	4382	5171	6082

- Chrome leg levelers
- Extra-thick, high-density cushions
- No-sag sinuous wire spring seat and back suspensions
- Optional tablets are located on outside of arm, specify left or right facing and indicate finish
- Seat: 43.5" W x 20" D x 19" H

OPTION	PRICE	CODE
Softer Seat Foam-Loveseat	32.00	SF
Genesis Tablet	514.00	GT
Pivoting Tablet	514.00	LT
Double Pivot Tablet	689.00	DT

QS NOW

5906MET Sofa

76" W X 29" D X 32.5" H

St. Yardage: 10.5

Seat & Back Ydg: 8.5

Arms Ydg: 3



SIN #711-17

FREIGHT CLASS: 250
CUBIC FT: 75
SHIP WEIGHT: 159

Grade	1	2	3	4	5	6	7	8	9	10	L	LL
Zone 1	3028	3286	3548	3827	4081	4418	4548	5091	5428	5849	6887	7682
Zone 2	3073	3335	3601	3884	4142	4484	4616	5167	5509	5937	6990	7797
Zone 3	3119	3385	3654	3942	4203	4551	4684	5244	5591	6024	7094	7912

- Chrome leg levelers
- Extra-thick, high-density foam cushions
- No-sag sinuous wire spring seat and back suspensions
- Optional tablets are located on outside of arm, specify left or right facing and indicate finish
- Seat: 65" W x 20" D x 19" H

OPTION	PRICE	CODE
Softer Seat Foam-Sofa	48.00	SF
Genesis Tablet	514.00	GT
Pivoting Tablet	514.00	LT
Double Pivot Tablet	689.00	DT

QS NOW

5921 Oval Table, Floating Laminate Top

42.5"W X 21.5"D X 19.25"H St. Yardage: 1.75



SIN #711-11

FREIGHT CLASS: 175
CUBIC FT: 25.2
SHIP WEIGHT: 89

Grade	1	2	3	4	5	6	7	8	9	10	L	LL
Zone 1	1390	1417	1448	1475	1502	1538	1573	1609	1645	1690	1775	1976
Zone 2	1411	1438	1470	1497	1525	1561	1597	1633	1670	1715	1802	2006
Zone 3	1432	1460	1491	1519	1547	1584	1620	1657	1694	1741	1828	2035

- 1" thick thermally fused laminate tops available in all Hyperwork finishes
- Middle section of table is fully upholstered
- Anodized aluminum spacers create a floating top
- Brushed aluminum cylinder legs with chrome leg levelers

QS NOW

5922 Oval Table, Laminate Top

42.5"W X 21.5"D X 17.25"H St. Yardage: 1.75



SIN #711-11

FREIGHT CLASS: 175
CUBIC FT: 25.2
SHIP WEIGHT: 86

Grade	1	2	3	4	5	6	7	8	9	10	L	LL
Zone 1	1358	1385	1416	1443	1470	1506	1541	1577	1613	1658	1743	1944
Zone 2	1378	1406	1437	1465	1492	1529	1564	1601	1637	1683	1769	1973
Zone 3	1399	1427	1458	1486	1514	1551	1587	1624	1661	1708	1795	2002

- 1" thick thermally fused laminate tops available in all Hyperwork finishes
- Fully upholstered sides
- Brushed aluminum cylinder legs with chrome leg levelers

QS NOW

5926 Oval Table, Fully Upholstered

42.5"W X 21.5"D X 16.25"H St. Yardage: 1.75



SIN #711-11

FREIGHT CLASS: 175
CUBIC FT: 25.2
SHIP WEIGHT: 74

Grade	1	2	3	4	5	6	7	8	9	10	L	LL
Zone 1	1159	1186	1217	1244	1271	1307	1342	1379	1414	1459	1544	1745
Zone 2	1176	1204	1235	1263	1290	1327	1362	1400	1435	1481	1567	1771
Zone 3	1194	1222	1254	1281	1309	1346	1382	1420	1456	1503	1590	1797

- Fully upholstered
- Brushed aluminum cylinder legs with chrome leg levelers

QS NOW

5936MET Round Table, Laminate Top

36"W X 36"D X 22.5"H St. Yardage: 1.75

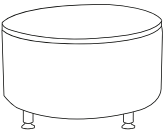

SIN #711-11

FREIGHT CLASS: 175
CUBIC FT: 41.5
SHIP WEIGHT: 135

Grade	1	2	3	4	5	6	7	8	9	10	L	LL
Zone 1	1667	1718	1778	1829	1880	1948	2015	2083	2151	2236	2397	2779
Zone 2	1692	1744	1805	1856	1908	1977	2045	2114	2183	2270	2433	2821
Zone 3	1717	1770	1831	1884	1936	2006	2075	2145	2216	2303	2469	2862

- 1" thick thermally fused laminate top available in all Hyperwork finishes
- Upholstered sides

QS NOW

5948MET Round Table/Ottoman with metal legs

48"W X 48"D X 14.5"H St. Yardage: 3

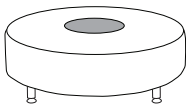

SIN #711-11

FREIGHT CLASS: 125
CUBIC FT: 48.5
SHIP WEIGHT: 153

Grade	1	2	3	4	5	6	7	8	9	10	L	LL
Zone 1	2100	2143	2201	2246	2289	2355	2413	2478	2537	2609	2784	3111
Zone 2	2132	2175	2234	2280	2323	2390	2449	2515	2575	2648	2826	3158
Zone 3	2163	2207	2267	2313	2358	2426	2485	2552	2613	2687	2868	3204

- Upholstered with 18" round target table in center of top
 - Brushed aluminum cylinder legs with chrome leg levelers
- | OPTION | PRICE | CODE |
|------------|--------|------|
| Tufted Top | 300.00 | TF |

QS NOW

Sit Side-By-Side in Comfort

Generous armrests separate and create private space for each individual. Especially suited for public areas and waiting rooms, the gentle curves and substantial visual scale of **Accompany** creates an impression of comfort, encouraging users to relax.

Two-Color Combinations: Unit invoiced at the highest fabric price grade featured on unit.

MODULAR ORDER DETAIL:

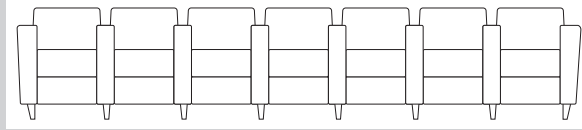

This Accompany Metal Modular order would consist of the following model numbers:

- (1) **5913MET** Left End Unit
- (1) **5914MET** Right End Unit
- (5) **5911** Center Seats
- (6) **5912MET** Center Arms

Accompany Metal Modular

5911 Center Seat, Requires Two 5912MET Center Arms 22" W X 29" D X 28" H St. Yardage: 3

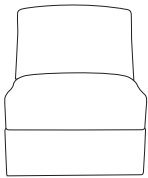

SIN #711-17

FREIGHT CLASS: 250
CUBIC FT: 20
SHIP WEIGHT: 37

QS NOW

Grade	1	2	3	4	5	6	7	8	9	10	L	LL
Zone 1	672	776	881	945	1032	1065	1206	1293	1402	1610	1906	2101
Zone 2	682	788	894	959	1047	1081	1224	1312	1423	1634	1935	2133
Zone 3	692	799	907	973	1063	1097	1242	1332	1444	1658	1963	2164

- Extra-thick seat foam
- No-sag spring seat/back suspensions
- Hardwood frame
- Requires easy bolt-on assembly
- Seat: 21"W x 20"D x 19"H
- Unit height will be 32.5"H when connected

OPTION	PRICE	CODE
Softer Seat Foam-Chair	16.00	SF
Center Seat with one Center Arm: Cube Ft: 20, Ship Wt: 63		
Center Seat with two Center Arms: Cubic Ft: 22.4, Ship Wt: 83		

5912MET Center Arm

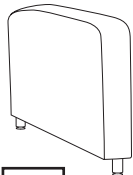

SIN #711-17

FREIGHT CLASS: 70
CUBIC FT: 6
SHIP WEIGHT: 20

QS NOW

6" W X 29" D X 27" H St. Yardage: 1.75

Grade	1	2	3	4	5	6	7	8	9	10	L	LL
Zone 1	419	473	521	556	600	616	642	686	730	786	888	1066
Zone 2	425	480	529	564	609	625	652	696	741	798	901	1082
Zone 3	432	487	537	573	618	634	661	707	752	810	915	1098

- Chrome leg levelers
- Easy bolt-on assembly
- Ships with 5911 center seat

5913MET Left Arm Unit, Ships with Arm/Seat Assembled 26.5" W X 29" D X 32.5" H St. Yardage: 4.75 Seat & Back Ydg: 3 Arms Ydg: 1.75

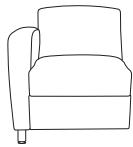

SIN #711-17

FREIGHT CLASS: 250
CUBIC FT: 28
SHIP WEIGHT: 56

QS NOW

Grade	1	2	3	4	5	6	7	8	9	10	L	LL
Zone 1	1077	1236	1381	1487	1618	1669	1774	1879	2011	2175	2485	3025
Zone 2	1093	1255	1402	1509	1642	1694	1801	1907	2041	2208	2522	3070
Zone 3	1109	1273	1422	1532	1667	1719	1827	1935	2071	2240	2560	3116

- Chrome leg levelers
- Extra-thick, high-density foam cushions
- No-sag sinuous wire spring seat and back suspensions
- Easy bolt-on assembly
- Seat: 21"W x 20"D x 19"H

OPTION	PRICE	CODE
Softer Seat Foam-Chair	16.00	SF

5914MET Right Arm Unit, Ships with Arm/Seat Assembled 26.5" W X 29" D X 32.5" H St. Yardage: 4.75 Seat & Back Ydg: 3 Arms Ydg: 1.75

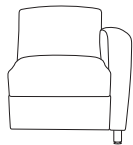

SIN #711-17

FREIGHT CLASS: 250
CUBIC FT: 28
SHIP WEIGHT: 56

QS NOW

Grade	1	2	3	4	5	6	7	8	9	10	L	LL
Zone 1	1077	1236	1381	1487	1618	1669	1774	1879	2011	2175	2485	3025
Zone 2	1093	1255	1402	1509	1642	1694	1801	1907	2041	2208	2522	3070
Zone 3	1109	1273	1422	1532	1667	1719	1827	1935	2071	2240	2560	3116

- Chrome leg levelers
- Extra-thick, high-density foam cushions
- No-sag sinuous wire spring seat and back suspensions
- Easy bolt-on assembly
- Seat: 21"W x 20"D x 19"H

OPTION	PRICE	CODE
Softer Seat Foam-Chair	16.00	SF

5904MET-CL Armless Chair-Connects Left Side Facing

22"W X 29"D X 32.5"H

St. Yardage: 3.5

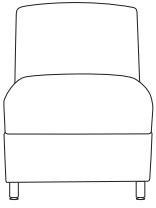

SIN #711-17

FREIGHT CLASS: 250
CUBIC FT: 20.0
SHIP WEIGHT: 49

Grade	1	2	3	4	5	6	7	8	9	10	L	LL
Zone 1	1209	1294	1378	1471	1553	1662	1705	1882	1991	2127	2468	3005
Zone 2	1227	1313	1399	1493	1576	1687	1731	1910	2021	2159	2505	3050
Zone 3	1245	1333	1419	1515	1600	1712	1756	1938	2051	2191	2542	3095

- 5904MET-CL connectable on left side facing
- Requires easy bolt-on assembly
- Seat: 22"W x 19"D x 16"H

OPTION	PRICE	CODE
Softer Seat Foam-Chair	16.00	SF

QS NOW

5904MET-CR Armless Chair-Connects Right Side Facing

22"W X 29"D X 32.5"H

St. Yardage: 3.5

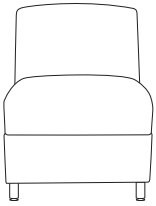

SIN #711-17

FREIGHT CLASS: 250
CUBIC FT: 20.0
SHIP WEIGHT: 49

Grade	1	2	3	4	5	6	7	8	9	10	L	LL
Zone 1	1209	1294	1378	1471	1553	1662	1705	1882	1991	2127	2468	3005
Zone 2	1227	1313	1399	1493	1576	1687	1731	1910	2021	2159	2505	3050
Zone 3	1245	1333	1419	1515	1600	1712	1756	1938	2051	2191	2542	3095

- 5904MET-CR connectable on right side facing
- Requires easy bolt-on assembly
- Seat: 22"W x 19"D x 16"H

OPTION	PRICE	CODE
Softer Seat Foam-Chair	16.00	SF

QS NOW

5904MET-CLR Armless Chair-Connects Both Sides

22"W X 29"D X 32.5"H

St. Yardage: 3.5

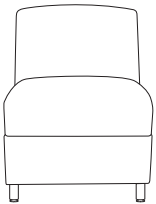

SIN #711-17

FREIGHT CLASS: 250
CUBIC FT: 20.0
SHIP WEIGHT: 49

Grade	1	2	3	4	5	6	7	8	9	10	L	LL
Zone 1	1209	1294	1378	1471	1553	1662	1705	1882	1991	2127	2468	3005
Zone 2	1227	1313	1399	1493	1576	1687	1731	1910	2021	2159	2505	3050
Zone 3	1245	1333	1419	1515	1600	1712	1756	1938	2051	2191	2542	3095

- 5904MET-CLR connectable on both sides
- Requires easy bolt-on assembly
- Seat: 22"W x 19"D x 16"H

OPTION	PRICE	CODE
Softer Seat Foam-Chair	16.00	SF

QS NOW

Mobile. Versatile. Comfortable.

Combining the comfort of lounge seating with the high functionality of team seating, **Genesis Team Seating** is a new alternative for innovative environments.



1737 Genesis with casters

Genesis Details

- Dual-wheel, easy-rolling casters for mobility
- Unique 360-degree revolving shaped tablet for note-taking or laptop support
- Tablet easily relocates on left or right arm
- Storage compartment under seat
- Standard black finish arms and tablet
- Fabric combinations available with seat/back differing from arm panels

Additional Options

- Storage drawer with upholstered front
- Wood finish arms and tablet
- Cup holder secures mugs, drink cans, etc.
- Document holder supports work materials from training manuals to large-size textbooks
- Newspaper Holder accommodates papers, magazines and up to 10 training binders

Power option

Power module can be installed in arm or in drawer front. See page 135.

Genesis Team

1727 Team Chair

27" W X 26" D X 31.25" H

St. Yardage: 4.75 (Seat & Back 3, Arms 2.5)



Freight Class: 125
Cubic Ft: 19
Ship Weight: 78

QS NOW

Grade	1	2	3	4	5	6	7	8	9	10	L	LL
Zone 1	1900	1997	2108	2205	2301	2428	2478	2685	2813	2973	3277	3819
Zone 2	1929	2027	2140	2238	2336	2464	2515	2725	2855	3018	3326	3876
Zone 3	1957	2057	2171	2271	2370	2501	2552	2766	2897	3062	3375	3934

- Open storage area under seat 22" x 18" x 10"
- Black arm caps, tablet arm and shelf
- 16.5" x 10.75" tablet arm
- supports up to 15 lb. evenly distributed
- Mounted on casters for mobility
- Seat: 21"W X 20"D X 18.5"H

OPTION	PRICE	CODE
Self-Locking Casters	85.00	S

1727D Team Chair

27" W X 26" D X 31.25" H

St. Yardage: 4.75 (Seat & Back 3, Arms 2.5)



Freight Class: 125
Cubic Ft: 19
Ship Weight: 92

QS NOW

Grade	1	2	3	4	5	6	7	8	9	10	L	LL
Zone 1	2095	2192	2303	2399	2496	2624	2672	2879	3008	3167	3471	4014
Zone 2	2126	2225	2338	2435	2533	2663	2712	2922	3053	3215	3523	4074
Zone 3	2158	2258	2372	2471	2571	2703	2752	2965	3098	3262	3575	4134

- Storage drawer with full-extension slides and upholstered front
- Drawer interior 16.25" x 17" x 5.5"
- Black arms caps and tablet arm
- 16.5" x 10.75" Tablet arm supports up to 15 lb. evenly distributed
- Mounted on casters for mobility
- Seat: 21"W X 20"D X 18.5"H

OPTION	PRICE	CODE
Self-Locking Casters	85.00	S

1747 Oversized Team Chair

30" W X 26" D X 35.75" H

St. Yardage: 5.25 (Seat & Back 3, Arms 2.5)



Freight Class: 125
Cubic Ft: 20
Ship Weight: 87

QS NOW

Grade	1	2	3	4	5	6	7	8	9	10	L	LL
Zone 1	2102	2185	2283	2365	2449	2561	2671	2782	2894	3033	3296	3922
Zone 2	2134	2218	2317	2400	2486	2599	2711	2824	2937	3078	3345	3981
Zone 3	2165	2251	2351	2436	2522	2638	2751	2865	2981	3124	3395	4040

- Open storage area under seat 25"W x 18"D x 10"H
- Black arm caps, tablet arm and shelf
- 16.5" x 10.75" tablet arm supports up to 15 lb. evenly distributed
- Mounted on casters for mobility
- Seat: 24"W X 20"D X 18.5"H

OPTION	PRICE	CODE
Self-Locking Casters	85.00	S

FINISH SELECTION

ASPEN **AP** | BOARDWALK **BW** | DRIFTWOOD **DW** | ESPRESSO **ESP** | HONEY CHERRY **HCY** | MAHOGANY **MAH** | MOAB **MOB** | NATURAL **FM** | ROUGE MAHOGANY **RM** | WINDSOR CHERRY **WC** | SHORELINE **SL** |

SIN 711-18 **GENESIS**

CONTEMPORARY

1737 Team Chair



Freight Class: 125
Cubic Ft: 19
Ship Weight: 85

QS NOW

27" W X 26" D X 31.25" H

St. Yardage: 4.75 (Seat & Back 3, Arms 2.5)

Grade	1	2	3	4	5	6	7	8	9	10	L	LL
Zone 1	2098	2194	2305	2401	2498	2626	2674	2881	3010	3170	3474	4016
Zone 2	2129	2227	2340	2437	2535	2665	2714	2924	3055	3218	3526	4076
Zone 3	2161	2260	2374	2473	2573	2705	2754	2967	3100	3265	3578	4136

- Open storage area under seat 22" x 18" x 10"
- Solid wood arm caps, tablet arm and shelf (specify finish)
- Mounted on casters for mobility
- 16.5" x 10.75" tablet arm supports up to 15 lb. evenly distributed
- Seat: 21"W X 20"D X 18.5"H

OPTION	PRICE	CODE
Self-Locking Casters	85.00	S

1757 Oversized Team Chair



Freight Class: 125
Cubic Ft: 19
Ship Weight: 85

QS NOW

30" W X 26" D X 35.75" H

St. Yardage: 5.25 (Seat & Back 3, Arms 2.5)

Grade	1	2	3	4	5	6	7	8	9	10	L	LL
Zone 1	2319	2403	2501	2582	2666	2778	2889	2999	3111	3250	3514	4139
Zone 2	2354	2439	2539	2621	2706	2820	2932	3044	3158	3299	3567	4201
Zone 3	2389	2475	2576	2659	2746	2861	2976	3089	3204	3348	3619	4263

- Open storage area under seat 25"W x 18"D x 10"H
- Solid wood arm caps, tablet arm and shelf (specify finish)
- 16.5" x 10.75" tablet arm supports up to 15 lb. evenly distributed
- Mounted on casters for mobility
- Seat: 24"W X 20"D X 18.5"H

OPTION	PRICE	CODE
Self-Locking Casters	85.00	S

1737D Team Chair



Freight Class: 125
Cubic Ft: 19
Ship Weight: 96

QS NOW

27" W X 26" D X 31.25" H

St. Yardage: 4.75 (Seat & Back 3, Arms 2.5)

Grade	1	2	3	4	5	6	7	8	9	10	L	LL
Zone 1	2300	2396	2508	2604	2700	2828	2877	3084	3213	3372	3676	4219
Zone 2	2335	2432	2546	2643	2741	2870	2920	3130	3261	3423	3731	4282
Zone 3	2369	2468	2583	2682	2781	2913	2963	3177	3309	3473	3786	4346

- Storage drawer with full extension slides and upholstered front
- Drawer interior 16.25" x 17" x 5.5"
- Solid wood arm caps and tablet arm (specify finish)
- Mounted on casters for mobility
- 16.5" x 10.75" tablet arm supports up to 15 lb. evenly distributed
- Seat: 21"W X 20"D X 18.5"H

OPTION	PRICE	CODE
Self-Locking Casters	85.00	S

CH Cup Holder

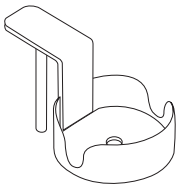

- Holds cans, coffee mugs, etc.
- Interior diameter 3-7/8"
- Heavy gauge steel
- Black powder coated finish
- Easily relocates to right or left arm
- Can ship via ground service

FREIGHT CLASS: 70
CUBIT FT: 1
SHIP WT: 1

4" W X 7" D X 3" H

St. Yardage: n/a

Zone Pricing	1	2	3
--------------	---	---	---

208 211 214

DH Document Holder

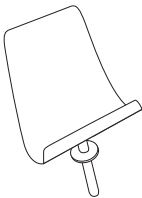

- Holds papers, training manuals, books, etc
- Angled for proper positioning of material
- Heavy gauge steel
- Black powder coated finish
- Easily relocates to right or left arm
- Can ship via ground service

FREIGHT CLASS: 70
CUBIT FT: 1
SHIP WT: 3

9.75" W X 3" D X 10.5" H

St. Yardage: n/a

195 198 201

NH Newspaper Holder

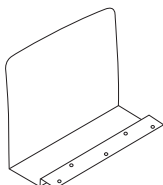

- Holds newspapers and magazines
- Positioned 1" from arm panel to hold up to 1" binder
- Heavy gauge steel
- Black powder coated finish
- Mounts under storage shelf
- Can ship via ground service

FREIGHT CLASS: 70
CUBIT FT: 1
SHIP WT: 5

14" W X 7" D X 11.5" H

St. Yardage: n/a

94 95 97

Flex Tiered Seating offers comfortable, multi-level seating for groups to gather for impromptu meetings or casual gatherings. Ideal for classroom, conference room, lounge or open atrium areas. Flex makes perimeter spaces useful. Two-and three-tier options plus the two-tier corner modules may be grouped and reconfigured to create a variety of seating spaces.

Power Option

Power Modules can be installed in bottom tier at either left or right of center. Left side facing is standard. Power is not available on inside facing corner unit. See page 135.



Flex Tiered Seating

2002 2-Tiered Seat

37"W X 41"D X 35"H

St. Yardage: 5.5

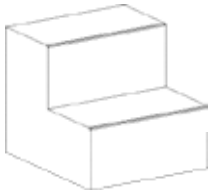

SIN #711-17

FREIGHT CLASS: 200
CUBIC FT: 40
SHIP WEIGHT: 140

Grade	1	2	3	4	5	6	7	8	9	10	L	LL
Zone 1	1716	1793	1896	1974	2051	2167	2270	2386	2489	2618	2927	3507
Zone 2	1742	1820	1924	2004	2082	2200	2304	2422	2526	2657	2971	3560
Zone 3	1767	1847	1953	2033	2113	2232	2338	2458	2564	2697	3015	3612

- Fully upholstered with double needle stitching
- 2" Ultra-cell foam in seat and .5" Ultra-cell foam in vertical surfaces
- Engineered hardwood frames include corner blocks
- Seats at 18" and 35" height are 21" and 20" deep
- 2" heavy-duty adjustable glides

QS NOW

2003 3-Tiered Seat

37"W X 41"D X 35"H

St. Yardage: 5.5

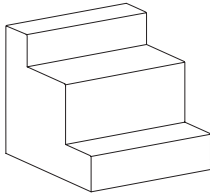

SIN #711-17

FREIGHT CLASS: 200
CUBIC FT: 40
SHIP WEIGHT: 130

Grade	1	2	3	4	5	6	7	8	9	10	L	LL
Zone 1	1862	1939	2042	2120	2197	2313	2416	2532	2635	2764	3073	3653
Zone 2	1890	1968	2073	2152	2230	2348	2452	2570	2675	2805	3119	3708
Zone 3	1918	1997	2103	2184	2263	2382	2488	2608	2714	2847	3165	3763

- Fully upholstered with double needle stitching
- 2" Ultra-cell foam in seat and .5" Ultra-cell foam in vertical surfaces
- Engineered hardwood frames include corner blocks
- Seats at 10.5" and 26.5" and 35" height are 12.5", 18" and 10.5" deep
- 2" heavy-duty adjustable glides

QS NOW

2002IF 2-Tiered Inside Facing Corner Seat

41"W X 41"D X 35"H

St. Yardage: 7.5

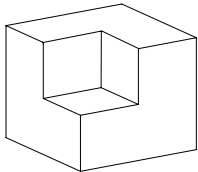

SIN #711-17

FREIGHT CLASS: 200
CUBIC FT: 40
SHIP WEIGHT: 149

Grade	1	2	3	4	5	6	7	8	9	10	L	LL
Zone 1	2342	2447	2588	2693	2799	2957	3097	3256	3396	3572	3994	4784
Zone 2	2377	2484	2627	2733	2841	3001	3143	3305	3447	3626	4054	4856
Zone 3	2412	2520	2666	2774	2883	3046	3190	3354	3498	3679	4114	4928

- Use inside-facing corner to change direction in layout
- Fully-upholstered with double needle stitching
- 2" Ultra-cell foam in seat and .5" Ultra cell foam in vertical surfaces
- Engineered hardwood frames include corner blocks
- Seats at 18" and 35" height are 21" and 20" deep
- 2" heavy-duty adjustable glides

QS NOW

2002OF 2-Tiered Outside Facing Corner Seat

41"W X 41"D X 35"H

St. Yardage: 7.5

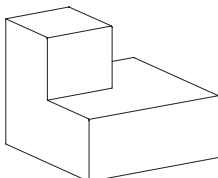

SIN #711-17

FREIGHT CLASS: 200
CUBIC FT: 40
SHIP WEIGHT: 132

Grade	1	2	3	4	5	6	7	8	9	10	L	LL
Zone 1	2342	2447	2588	2693	2799	2957	3097	3256	3396	3572	3994	4784
Zone 2	2377	2484	2627	2733	2841	3001	3143	3305	3447	3626	4054	4856
Zone 3	2412	2520	2666	2774	2883	3046	3190	3354	3498	3679	4114	4928

- Use outside-facing corner to change direction in layout
- Fully-upholstered with double needle stitching
- 2" Ultra-cell foam in seat and .5" Ultra cell foam in vertical surfaces
- Engineered hardwood frames include corner blocks
- Seats at 128" and 35" height are 21" and 20" deep
- 2" heavy-duty adjustable glides

QS NOW

Flex Collaborative Ottomans

HPFi's fully-upholstered ottomans are available in a wide variety of shapes - cubes, circles, octagonal, two-seat bench or tapers. Other variations include adding angled brushed aluminum legs or a trumpet base to create bistro-height seating. Use as ottomans, extra seating. Mix and match upholstery to create colorful seating in children's areas.



Fully Upholstered Ottomans

1554 Upholstered Cube

20"W X 20"D X 18"H

St. Yardage: 1.75

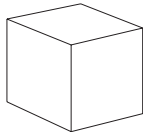

SIN #711-16

FREIGHT CLASS: 200
CUBIC FT: 10
SHIP WEIGHT: 41

Grade	1	2	3	4	5	6	7	8	9	10	L	LL
Zone 1	669	698	731	760	789	828	865	905	943	992	1083	1299
Zone 2	679	708	742	771	801	840	878	919	957	1007	1099	1318
Zone 3	689	719	753	783	813	853	891	932	971	1022	1115	1338

- Fully upholstered
- Use for extra seating
- Use alone or ganged for a unique/distinctive coffee table
- Black 3/4" H cylindrical gliding feet

OPTION	PRICE	CODE
Casters	20.00	C

QS NOW

1517 Student Size Upholstered Cube/Ottoman

15"W X 15"D X 15"H

St. Yardage: 1.5

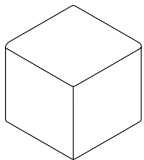

SIN #711-16

FREIGHT CLASS: 200
CUBIC FT: 10
SHIP WEIGHT: 16

Grade	1	2	3	4	5	6	7	8	9	10	L	LL
Zone 1	517	542	572	594	616	649	679	712	742	779	868	1035
Zone 2	525	550	581	603	625	659	689	723	753	791	881	1051
Zone 3	533	558	589	612	634	668	699	733	764	802	894	1066

- Child-size built for child-weight
- Fully-upholstered with 3" foam in top and .5" foam in vertical surfaces
- Core is expanded polystyrene
- Easily movable by children

QS NOW

1520 20" Diameter Ottoman

20"W X 20"D X 18"H

St. Yardage: 1.75

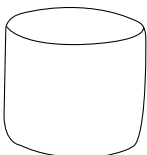

SIN #711-16

FREIGHT CLASS: 200
CUBIC FT: 10
SHIP WEIGHT: 46

Grade	1	2	3	4	5	6	7	8	9	10	L	LL
Zone 1	643	670	700	727	752	788	823	858	893	938	1021	1218
Zone 2	653	680	711	738	763	800	835	871	906	952	1036	1236
Zone 3	662	690	721	749	775	812	848	884	920	966	1052	1255

- Hardwood frame
- Fully upholstered top and sides
- Black 3/4" H cylindrical gliding feet

OPTION	PRICE	CODE
Casters	20.00	C

QS NOW

1524 24" Diameter Ottoman

24"W X 24"D X 18"H

St. Yardage: 1.75

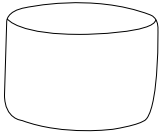

SIN #711-16

FREIGHT CLASS: 200
CUBIC FT: 10
SHIP WEIGHT: 56

Grade	1	2	3	4	5	6	7	8	9	10	L	LL
Zone 1	691	717	747	774	800	835	870	907	942	985	1069	1266
Zone 2	701	728	758	786	812	848	883	921	956	1000	1085	1285
Zone 3	712	739	769	797	824	860	896	934	970	1015	1101	1304

- Hardwood frame
- Fully upholstered top and sides
- Black 3/4" H cylindrical gliding feet

OPTION	PRICE	CODE
Casters	20.00	C

QS NOW

1536 36" Round Table/Ottoman

36"W X 36"D X 18.5"H

St. Yardage: 1.75

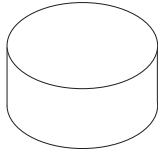

SIN #711-16

FREIGHT CLASS: 200
CUBIC FT: 40
SHIP WEIGHT: 91

Grade	1	2	3	4	5	6	7	8	9	10	L	LL
Zone 1	1197	1255	1324	1376	1428	1506	1575	1653	1722	1808	2016	2405
Zone 2	1215	1274	1344	1397	1449	1529	1599	1678	1748	1835	2046	2441
Zone 3	1233	1293	1364	1417	1471	1551	1622	1703	1774	1862	2076	2477

- Fully-upholstered with 3" foam in top and .5" foam in vertical surfaces
- Hardwood frame and corner blocks
- Black .625" high glider feet

OPTION	PRICE	CODE
Tufted Top	300.00	TF

QS NOW

1583 Tapered Ottoman with Black Glide Feet

16"/20.5"W X 16"/20.5"D X 24"H St. Yardage: 2

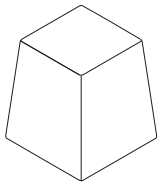

SIN #711-16

FREIGHT CLASS: 200
CUBIC FT: 12
SHIP WEIGHT: 24

Grade	1	2	3	4	5	6	7	8	9	10	L	LL
Zone 1	702	731	770	799	828	871	910	954	993	1041	1157	1376
Zone 2	713	742	782	811	840	884	924	968	1008	1057	1174	1397
Zone 3	723	753	793	823	853	897	937	983	1023	1072	1192	1417

- Upholstered ottoman tapers from 16" wide at top to 20" wide at bottom
- Fully-upholstered over 3" foam in top and .5" foam in sides
- Hardwood frame and corner blocks
- Black 3/4" high cylindrical glider feet

QS NOW

1584 Tapered Ottoman with Taper Aluminum Feet

16"/20.5"W X 16"/20.5"D X 30"H St. Yardage: 2

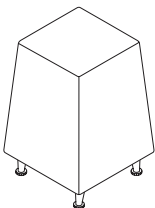

SIN #711-18

FREIGHT CLASS: 200
CUBIC FT: 13.1
SHIP WEIGHT: 28

Grade	1	2	3	4	5	6	7	8	9	10	L	LL
Zone 1	814	849	896	931	966	1019	1066	1119	1165	1224	1365	1628
Zone 2	826	862	909	945	980	1034	1082	1136	1182	1242	1385	1652
Zone 3	838	874	923	959	995	1050	1098	1153	1200	1261	1406	1677

- Upholstered ottoman tapers from 16" wide at top to 20" wide at bottom
- Fully-upholstered over 3" foam in top and .5" foam in sides
- Hardwood frame and corner blocks
- Angles satin finish chrome legs with stationary feet
- 30"H Bisto-height seating

QS NOW

15202 Round Ottoman with Trumpet Base

20"W X 20"D X 30"H

St. Yardage: 2

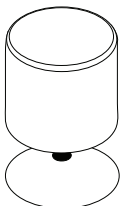

SIN #711-18

FREIGHT CLASS: 200
CUBIC FT: 13.1
SHIP WEIGHT: 82

Grade	1	2	3	4	5	6	7	8	9	10	L	LL
Zone 1	1234	1267	1307	1336	1366	1411	1450	1494	1534	1583	1702	1924
Zone 2	1253	1286	1327	1356	1386	1432	1472	1516	1557	1607	1728	1953
Zone 3	1271	1305	1346	1376	1407	1453	1494	1539	1580	1630	1753	1982

- Round ottoman ton trumpet base
- Fully-upholstered over 3" foam in top and .5" foam in sides
- Hardwood frame and corner blocks
- 30"H Bisto-height seating

QS NOW

1532 Octagonal Shaped Ottoman

32"W X 32"D X 18.5"H

St. Yardage: 2

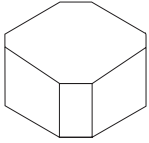

SIN #711-16

FREIGHT CLASS:
CUBIC FT: 40.8
SHIP WEIGHT: 80

QS NOW

Grade	1	2	3	4	5	6	7	8	9	10	L	LL
Zone 1	1346	1404	1473	1525	1577	1655	1724	1802	1871	1957	2165	2554
Zone 2	1366	1425	1495	1548	1601	1680	1750	1829	1899	1986	2197	2592
Zone 3	1386	1446	1517	1571	1624	1705	1776	1856	1927	2016	2230	2631

- Octagon shape is 20" wide at connectable ends
- Fully-upholstered with 3" foam in top and 5" foam in vertical surfaces
- Hardwood frame and corner blocks
- Black .625" high glider feet

1542 Two-Seat Bench

42"W X 20"D X 18.5"H

St. Yardage: 2.5

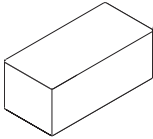

SIN #711-16

FREIGHT CLASS:
CUBIC FT: 12.7
SHIP WEIGHT: 49

QS NOW

Grade	1	2	3	4	5	6	7	8	9	10	L	LL
Zone 1	1099	1141	1190	1227	1264	1320	1369	1425	1474	1536	1684	1962
Zone 2	1115	1158	1208	1245	1283	1340	1390	1446	1496	1559	1709	1991
Zone 3	1132	1175	1226	1264	1302	1360	1410	1468	1518	1582	1735	2021

- Fully-upholstered with 3" foam in top and 5" foam in vertical surfaces
- Hardwood frame and corner blocks
- Black .625" high glider feet

CONTEMPORARY

Create Your Own Space

With the **7300/7400** Modular Collection, create unique configurations, adapt to building layouts and maximize seating capacity. Choose from 12 seating/table components. Approach benches (7300 Series) from either side in open areas. Units with backs (7400 Series) provide full-comfort seating. Freestanding and ganging tables are available in various shapes and sizes.

7300/7400 Details

- High pressure laminate bases and tables
- Black recessed plinth base
- .625" H glider feet protect carpet and floor
- Freestanding & ganging tables
- Replaceable cushions

Power Option

Power modules can be installed in front of upholstered seat. See page 135.

Custom Laminate Program

Any Wilsonart® laminate from the Design Group 1™ program (type 335 grade laminate) is available at an upcharge per unit. Upcharge is specified in each item description. Please specify the Wilsonart® laminate color when ordering.

Customer's Own Laminate Program: You may supply your own laminate at the listed upcharges. Please provide the exact quantity for each model number. The laminate manufacturer, color number, and grade must be provided also. We reserve the right to reject any laminate that does not meet our manufacturing requirements.

(*) Laminate requirements based on solid-color, non-directional design per single unit. For any laminate with pattern and/or multiple units, contact Customer Service for specific requirements.

These options not available on Quick Ship or regular lead time. Please call Customer Support for delivery dates.



7300/7400 Modular

7301 Reception Bench

25" W X 28.5" D X 19.5" H

St. Yardage: 1.5

SIN #711-17

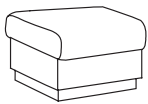

FREIGHT CLASS: 250
CUBIC FT: 15
SHIP WEIGHT: 55

Grade	1	2	3	4	5	6	7	8	9	10	L	LL
Zone 1	782	851	910	940	987	1007	1051	1088	1139	1200	1318	1564
Zone 2	794	864	924	954	1002	1022	1067	1104	1156	1218	1338	1587
Zone 3	805	877	937	968	1017	1037	1083	1121	1173	1236	1358	1611

- One seat upholstered bench
- Approachable from either side
- Freestanding or connect to other units
- See features in series overview
- Seat: 24"W x 28"D x 19.5"H

OPTION	PRICE	CODE
Softer Seat Foam-Chair	16.00	SF
Custom Laminate 1-Seat	120.00	S

QS NOW

7302 Reception Bench

50" W X 28.5" D X 19.5" H

St. Yardage: 3

SIN #711-17

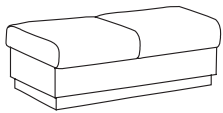

FREIGHT CLASS: 250
CUBIC FT: 36
SHIP WEIGHT: 90

Grade	1	2	3	4	5	6	7	8	9	10	L	LL
Zone 1	1309	1430	1537	1566	1602	1694	1732	1882	1977	2093	2315	2776
Zone 2	1329	1451	1560	1589	1626	1719	1758	1910	2007	2124	2350	2818
Zone 3	1348	1473	1583	1613	1650	1745	1784	1938	2036	2156	2384	2859

- Two seat upholstered bench
- Approachable from either side
- Freestanding or connect to other units
- See features in series overview
- Seat: 49"W x 28"D x 19.5"H

OPTION	PRICE	CODE
Softer Seat Foam-Loveseat	32.00	SF
Custom Laminate 2-Seat	135.00	S

QS NOW

7303 Reception Bench

74" W X 28.5" D X 19.5" H

St. Yardage: 4.5

SIN #711-17

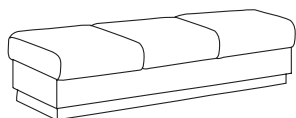

FREIGHT CLASS: 250
CUBIC FT: 40
SHIP WEIGHT: 127

Grade	1	2	3	4	5	6	7	8	9	10	L	LL
Zone 1	1968	2150	2315	2417	2561	2614	2846	2990	3170	3352	3625	4200
Zone 2	1998	2182	2350	2453	2599	2653	2889	3035	3218	3402	3679	4263
Zone 3	2027	2215	2384	2490	2638	2692	2931	3080	3265	3453	3734	4326

- Three seat upholstered bench
- Approachable from either side
- Freestanding or connect to other units
- See features in series overview
- Seat: 73"W x 28"D x 19.5"H

OPTION	PRICE	CODE
Softer Seat Foam-Sofa	48.00	SF
Custom Laminate 3-Seat	150.00	S

QS NOW

7401 Chair



FREIGHT CLASS: 250
 CUBIC FT: 17
 SHIP WEIGHT: 59

QS NOW

25" W X 28.5" D X 30" H

St. Yardage: 2

SIN #711-17

Grade	1	2	3	4	5	6	7	8	9	10	L	LL
Zone 1	929	1012	1083	1125	1188	1213	1265	1312	1374	1452	1600	1910
Zone 2	943	1027	1099	1142	1206	1231	1284	1332	1395	1474	1624	1939
Zone 3	957	1042	1115	1159	1224	1249	1303	1351	1415	1496	1648	1967

- Freestanding or connect to other seating units or tables
- See features in series overview
- Seat: 25"W x 21"D x 19.5"H

OPTION	PRICE	CODE
Softer Seat Foam-Chair	16.00	SF
Custom Laminate 1-Seat	120.00	S

7402 Loveseat



FREIGHT CLASS: 250
 CUBIC FT: 37
 SHIP WEIGHT: 103

QS NOW

50" W X 28.5" D X 30" H

St. Yardage: 4

SIN #711-17

Grade	1	2	3	4	5	6	7	8	9	10	L	LL
Zone 1	1564	1722	1871	1954	2078	2126	2182	2329	2452	2608	3507	3722
Zone 2	1587	1748	1899	1983	2109	2158	2215	2364	2489	2647	3560	3778
Zone 3	1611	1774	1927	2013	2140	2190	2247	2399	2526	2686	3612	3834

- Freestanding or connect to other seating units or tables
- See features in series overview
- Seat: 50"W x 21"D x 19.5"H

OPTION	PRICE	CODE
Softer Seat Foam-Loveseat	32.00	SF
Custom Laminate 2-Seat	135.00	S

7403 Sofa

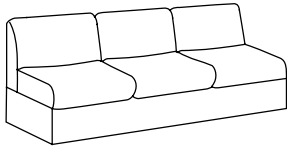

FREIGHT CLASS: 250
 CUBIC FT: 40
 SHIP WEIGHT: 140

QS NOW

74" W X 28.5" D X 30" H

St. Yardage: 6

SIN #711-17

Grade	1	2	3	4	5	6	7	8	9	10	L	LL
Zone 1	2303	2554	2768	2889	3074	3147	3223	3450	3637	3869	5229	5366
Zone 2	2338	2592	2810	2932	3120	3194	3271	3502	3692	3927	5307	5446
Zone 3	2372	2631	2851	2976	3166	3241	3320	3554	3746	3985	5386	5527

- Freestanding or connect to other seating units or tables
- See features in series overview
- Seat: 74"W x 21"D x 19.5"H

OPTION	PRICE	CODE
Softer Seat Foam-Sofa	48.00	SF
Custom Laminate 3-Seat	150.00	S

7420 Coffee Table

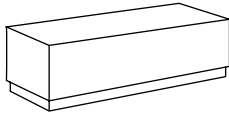

- Freestanding
- High pressure laminate top and sides
- Black recessed plinth base with a textured vinyl surface

FREIGHT CLASS: 150

QS

Zone Pricing	Zone Pricing				
	1	2	3		
52"W X 20"D X 14"H	Cubic Ft: 16	Ship Weight: 79	947	961	975
OPTION		PRICE	CODE		
Custom Laminate 7420		135.00	S		
SIN #711-11					

7421 Cylinder Table

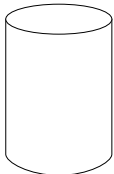

- Freestanding
- High pressure laminate top and sides

FREIGHT CLASS: 150

QS

19"W X 19"D X 14"H	Cubic Ft: 6	Ship Weight: 25	761	772	784
OPTION		PRICE	CODE		
Custom Laminate 7421		135.00	S		
SIN #711-11					

7423 End Table

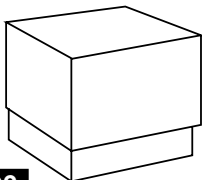

- Freestanding
- High pressure laminate top and sides
- Black recessed plinth base

FREIGHT CLASS: 150

QS

25"W X 25"D X 14"H	Cubic Ft: 10	Ship Weight: 55	821	833	846
OPTION		PRICE	CODE		
Custom Laminate 7423		135.00	S		
SIN #711-11					

7424 Connector Table

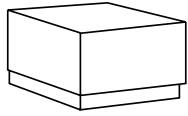

- Freestanding or connect to other units
- High pressure laminate top and sides
- Black recessed plinth base

QS

FREIGHT CLASS: 150

7425 45° Wedge Table

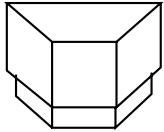

- 45° shape
- Connect to other units to form curves in layout
- High pressure laminate top and sides
- Black recessed plinth base

QS

FREIGHT CLASS: 150

7426 90° Corner Table

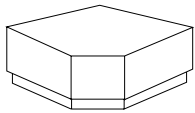

- Freestanding or connect to other units
- High pressure laminate top and sides
- Black recessed plinth base

QS

FREIGHT CLASS: 150

74A Ganging Kit



- 74A - Joins 7301, 7302, 7303, 7401, 7402, 7403, 7424
- Kit includes ganging plate and 8 screws

QS

FREIGHT CLASS: 70

74B Ganging Kit



- 74B - Joins 7425 Wedge Table
- Kit includes ganging plate and 8 screws

QS

FREIGHT CLASS: 70

74C Ganging Kit



- 74C - Joins 7426 Corner Table
- Kit includes ganging plate and 8 screws

QS

FREIGHT CLASS: 70

		Zone Pricing		1	2	3
18"W X 25"D X 11.5"H	Cubic Ft: 6	Ship Weight: 39	739	750	761	
		OPTION		PRICE	CODE	
		Custom Laminate 7424		135.00	S	
		SIN #711-11				
<hr/>						
8"W Front 27" Back X 25"D X 11.5"H	Cubic Ft: 6	Ship Weight: 39	918	932	946	
		OPTION		PRICE	CODE	
		Custom Laminate 7424		135.00	S	
		SIN #711-11				
<hr/>						
38"W X 38"D X 11.5"H	Cubic Ft: 18	Ship Weight: 83	1039	1055	1070	
		OPTION		PRICE	CODE	
		Custom Laminate 7424		135.00	S	
		SIN #711-11				
<hr/>						
10"W X 3"D X .065"H	Cubic Ft: .2	Ship Weight: .3	33	33	34	
		SIN #711-17				
<hr/>						
3.5"W X 3"D X .38"H	Cubic Ft: .2	Ship Weight: .3	33	33	34	
		SIN #711-17				
<hr/>						
3.5"W X 3"D X .75"H	Cubic Ft: .2	Ship Weight: .3	33	33	34	
		SIN #711-17				



Our Most Versatile Modular Collection

Steps Modular lounge seating components can be configured, expanded and reconfigured as your business grows and changes. Every component is a seating module, ensuring maximum seating capacity and optimum space-efficiency in your facilities.

Plus, seat/back modules are field replaceable, offering renewability down the road.

Steps Modular Details

- Bases are fully upholstered.
- Bases with radius corners and .625" H glider feet
- All Steps units are available with left or right (facing) arms.
- All units are shipped with metal fasteners pre-bored into the seat frames (nuts and bolts supplied).

Power Option

Power modules can be installed in front or in sides. See page 135.

STEPS Upholstered Base Modular

7431 One-Seat Module

25" W X 28.5" D X 30" H St. Yardage: 3.5

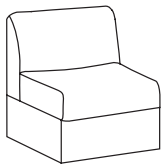

FREIGHT CLASS: 250
CUBIC FT: 16
SHIP WEIGHT: 57

Grade	1	2	3	4	5	6	7	8	9	10	L	LL
Zone 1	929	1031	1125	1174	1251	1353	1391	1558	1659	1786	2163	2490
Zone 2	943	1046	1142	1192	1270	1373	1412	1581	1684	1813	2195	2527
Zone 3	957	1062	1159	1209	1289	1394	1433	1605	1709	1840	2228	2565

- Fully upholstered
- Freestanding or connect to other units
- See features above
- Seat: 24"W x 21"D x 19.5"H

OPTION	PRICE	CODE
Softer Seat Foam-Chair	16.00	SF

QS NOW

7432 Two-Seat Module

50" W X 28.5" D X 30" H St. Yardage: 6

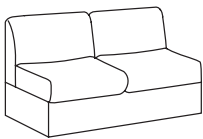

FREIGHT CLASS: 250
CUBIC FT: 36
SHIP WEIGHT: 106

Grade	1	2	3	4	5	6	7	8	9	10	L	LL
Zone 1	1564	1709	1861	1934	2052	2207	2267	2518	2674	2870	3441	4003
Zone 2	1587	1735	1889	1963	2083	2240	2301	2556	2714	2913	3493	4063
Zone 3	1611	1760	1917	1992	2114	2273	2335	2594	2754	2956	3544	4123

- Fully upholstered
- Freestanding or connect to other units
- See features above
- Seat: 50"W x 21"D x 19.5"H

OPTION	PRICE	CODE
Softer Seat Foam-Loveseat	32.00	SF

QS NOW

7433 Three-Seat Module

74" W X 28.5" D X 30" H St. Yardage: 8

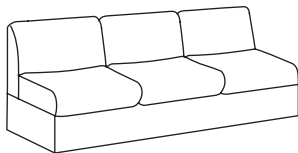

FREIGHT CLASS: 250
CUBIC FT: 40
SHIP WEIGHT: 138

Grade	1	2	3	4	5	6	7	8	9	10	L	LL
Zone 1	2303	2529	2747	2860	3036	3271	3362	3739	3974	4266	5124	5684
Zone 2	2338	2567	2788	2903	3082	3320	3412	3795	4034	4330	5201	5769
Zone 3	2372	2605	2829	2946	3127	3369	3463	3851	4093	4394	5278	5855

- Fully upholstered
- Freestanding or connect to other units
- See features above
- Seat: 74"W x 21"D x 19.5"H

OPTION	PRICE	CODE
Softer Seat Foam-Sofa	48.00	SF

QS NOW

7434 Inverted 45° Wedge Module

29.5" W X 27" D X 30" H St. Yardage: 3.25

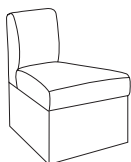

FREIGHT CLASS: 250
CUBIC FT: 16.5
SHIP WEIGHT: 52

Grade	1	2	3	4	5	6	7	8	9	10	L	LL
Zone 1	929	1031	1125	1174	1251	1353	1391	1558	1659	1786	2163	2490
Zone 2	943	1046	1142	1192	1270	1373	1412	1581	1684	1813	2195	2527
Zone 3	957	1062	1159	1209	1289	1394	1433	1605	1709	1840	2228	2565

- 45° shape, outside facing
- Fully upholstered
- Connect to other units to form curves in layout
- See features above
- Seat: 15-29.5"W x 20"D x 19.5"H

OPTION	PRICE	CODE
Softer Seat Foam-Chair	16.00	SF

QS NOW

7435 45° Wedge Seat Module

27.5" W X 25.75" D X 30" H St. Yardage: 3.75

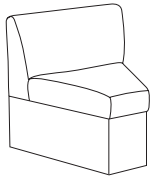

FREIGHT CLASS: 250
CUBIC FT: 15
SHIP WEIGHT: 54

QS NOW

Grade	1	2	3	4	5	6	7	8	9	10	L	LL
Zone 1	929	1031	1125	1174	1251	1353	1391	1558	1659	1786	2163	2490
Zone 2	943	1046	1142	1192	1270	1373	1412	1581	1684	1813	2195	2527
Zone 3	957	1062	1159	1209	1289	1394	1433	1605	1709	1840	2228	2565

- 45° shape, inside facing
- Fully upholstered
- Connect to other units to form curves in layout
- See features in series overview
- Seat: 8-23"W x 21"D x 19.5"H

OPTION	PRICE	CODE
Softer Seat Foam-Chair	16.00	SF

7436 90° Corner Seat Module

38" W X 38" D X 30" H St. Yardage: 5.5

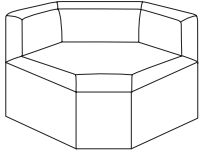

FREIGHT CLASS: 250
CUBIC FT: 35
SHIP WEIGHT: 91

QS NOW

Grade	1	2	3	4	5	6	7	8	9	10	L	LL
Zone 1	1936	2089	2244	2318	2423	2578	2639	2891	3047	3242	3888	4144
Zone 2	1965	2120	2278	2353	2459	2617	2679	2934	3093	3291	3946	4206
Zone 3	1994	2152	2311	2388	2496	2655	2718	2978	3138	3339	4005	4268

- 90° application (corners)
- 6-sided shape
- Fully upholstered
- Freestanding or connect to other units
- See features in series overview
- Seat: 34"W x 34"D x 19.5"H

OPTION	PRICE	CODE
Softer Seat Foam-Loveseat	32.00	SF

7339L Modular Left Arm

4.5" W X 23.5" D X 27" H St. Yardage: 2

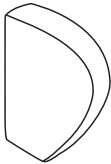

FREIGHT CLASS: 175
CUBIC FT: 6
SHIP WEIGHT: 17

QS NOW

Grade	1	2	3	4	5	6	7	8	9	10	L	LL
Zone 1	236	288	336	373	417	435	503	548	603	705	874	951
Zone 2	240	292	341	379	423	442	511	556	612	716	887	965
Zone 3	243	297	346	384	430	448	518	564	621	726	900	980

- Fully upholstered arm
- Connects to right side (facing) of any Steps Modular seat

7339R Modular Right Arm

4.5" W X 23.5" D X 27" H St. Yardage: 2



FREIGHT CLASS: 175
CUBIC FT: 6
SHIP WEIGHT: 17

QS NOW

Grade	1	2	3	4	5	6	7	8	9	10	L	LL
Zone 1	236	288	336	373	417	435	503	548	603	705	874	951
Zone 2	240	292	341	379	423	442	511	556	612	716	887	965
Zone 3	243	297	346	384	430	448	518	564	621	726	900	980

- Fully upholstered arm
- Connects to right side (facing) of any Steps Modular seat

7331 Square Bench Module

24" W X 28.5" D X 19.5" H St. Yardage: 1.5

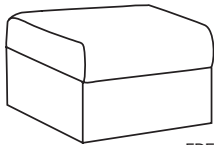

FREIGHT CLASS: 250
CUBIC FT: 15
SHIP WEIGHT: 48

QS NOW

Grade	1	2	3	4	5	6	7	8	9	10	L	LL
Zone 1	814	916	1017	1038	1080	1119	1144	1170	1200	1231	1631	2095
Zone 2	826	930	1032	1054	1096	1136	1161	1188	1218	1249	1655	2126
Zone 3	838	943	1048	1069	1112	1153	1178	1205	1236	1268	1680	2158

- One-seat fully upholstered bench
- Approachable from either side
- Freestanding or connect to other units
- See features in series overview
- Seat: 24"W x 28"D x 19.5"H

OPTION	PRICE	CODE
Softer Seat Foam-Chair	16 .00	SF

7332 Two Seat Bench Module

50" W X 28.5" D X 19.5" H St. Yardage: 3

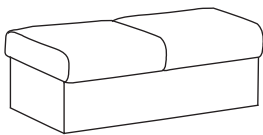

FREIGHT CLASS: 250
CUBIC FT: 37
SHIP WEIGHT: 90

QS NOW

Grade	1	2	3	4	5	6	7	8	9	10	L	LL
Zone 1	1389	1480	1587	1677	1768	1889	2010	2132	2252	2403	2691	3372
Zone 2	1410	1502	1611	1702	1795	1917	2040	2164	2286	2439	2731	3423
Zone 3	1431	1524	1635	1727	1821	1946	2070	2196	2320	2475	2772	3473

- Two-seat fully upholstered bench
- Approachable from either side
- Freestanding or connect to other units
- See features in series overview
- Seat: 49"W x 28"D x 19.5"H

OPTION	PRICE	CODE
Softer Seat Foam-Chair	32 .00	SF

7333 Three Seat Bench Module

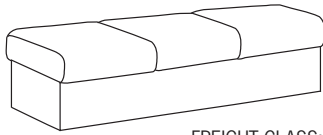

FREIGHT CLASS: 250
CUBIC FT: 40
SHIP WEIGHT: 122

QS NOW

74" W X 28.5" D X 19.5" H St. Yardage: 4.5

Grade	1	2	3	4	5	6	7	8	9	10	L	LL
Zone 1	2115	2251	2411	2545	2683	2865	3046	3227	3408	3636	4068	5089
Zone 2	2147	2285	2447	2583	2723	2908	3092	3275	3459	3691	4129	5165
Zone 3	2178	2319	2483	2621	2763	2951	3137	3324	3510	3745	4190	5242

- | <ul style="list-style-type: none"> • Three-seat fully upholstered bench • Approachable from either side | <ul style="list-style-type: none"> • Freestanding or connect to other units • See features in series overview • Seat: 73"W x 28"D x 19.5"H | <table border="1"> <thead> <tr> <th>OPTION</th> <th>PRICE</th> <th>CODE</th> </tr> </thead> <tbody> <tr> <td>Softer Seat Foam-Chair</td> <td>48.00</td> <td>SF</td> </tr> </tbody> </table> | OPTION | PRICE | CODE | Softer Seat Foam-Chair | 48.00 | SF |
|---|---|---|--------|-------|------|------------------------|-------|----|
| OPTION | PRICE | CODE | | | | | | |
| Softer Seat Foam-Chair | 48.00 | SF | | | | | | |

7335 45° Wedge Bench Module

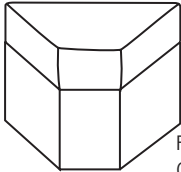

FREIGHT CLASS: 250
CUBIC FT: 15
SHIP WEIGHT: 45

QS NOW

27.5" W X 25.75" D X 19.5" H St. Yardage: 3

Grade	1	2	3	4	5	6	7	8	9	10	L	LL
Zone 1	814	916	1017	1038	1080	1119	1144	1170	1200	1231	1631	2095
Zone 2	826	930	1032	1054	1096	1136	1161	1188	1218	1249	1655	2126
Zone 3	838	943	1048	1069	1112	1153	1178	1205	1236	1268	1680	2158

- | <ul style="list-style-type: none"> • 45° shape • Fully upholstered • Connect to other units to form curves in layout | <ul style="list-style-type: none"> • See features in series overview • Seat: 8-27.5"W x 25.5"D x 19.5"H | <table border="1"> <thead> <tr> <th>OPTION</th> <th>PRICE</th> <th>CODE</th> </tr> </thead> <tbody> <tr> <td>Softer Seat Foam-Chair</td> <td>16.00</td> <td>SF</td> </tr> </tbody> </table> | OPTION | PRICE | CODE | Softer Seat Foam-Chair | 16.00 | SF |
|---|---|---|--------|-------|------|------------------------|-------|----|
| OPTION | PRICE | CODE | | | | | | |
| Softer Seat Foam-Chair | 16.00 | SF | | | | | | |

STEPS Upholstered Base Assembled

7441 Lounge Chair

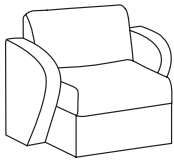

FREIGHT CLASS: 250
CUBIC FT: 29
SHIP WEIGHT: 84

QS NOW

34" W X 28.5" D X 30" H St. Yardage: 6.5

Grade	1	2	3	4	5	6	7	8	9	10	L	LL
Zone 1	1252	1398	1541	1608	1720	1869	1926	2169	2318	2505	3091	3474
Zone 2	1271	1419	1564	1632	1746	1897	1955	2202	2353	2543	3137	3526
Zone 3	1290	1440	1587	1656	1772	1925	1984	2234	2388	2580	3184	3578

- | <ul style="list-style-type: none"> • Fully upholstered • Ships fully assembled • Can be reconfigured | <ul style="list-style-type: none"> • See features in series overview • Seat: 25"W x 21"D x 19.5"H | <table border="1"> <thead> <tr> <th>OPTION</th> <th>PRICE</th> <th>CODE</th> </tr> </thead> <tbody> <tr> <td>Softer Seat Foam-Chair</td> <td>16.00</td> <td>SF</td> </tr> </tbody> </table> | OPTION | PRICE | CODE | Softer Seat Foam-Chair | 16.00 | SF |
|---|---|---|--------|-------|------|------------------------|-------|----|
| OPTION | PRICE | CODE | | | | | | |
| Softer Seat Foam-Chair | 16.00 | SF | | | | | | |

7442 Loveseat

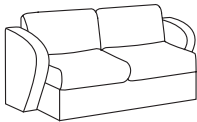

FREIGHT CLASS: 250
CUBIC FT: 40
SHIP WEIGHT: 127

QS NOW

59" W X 28.5" D X 30" H St. Yardage: 8.5

Grade	1	2	3	4	5	6	7	8	9	10	L	LL
Zone 1	1900	2099	2299	2389	2542	2750	2829	3162	3367	3624	4426	4812
Zone 2	1929	2130	2333	2425	2580	2791	2871	3209	3418	3678	4492	4884
Zone 3	1957	2162	2368	2461	2618	2833	2914	3257	3468	3733	4559	4956

- | <ul style="list-style-type: none"> • Fully upholstered • Ships fully assembled • Can be reconfigured | <ul style="list-style-type: none"> • See features in series overview • Seat: 50"W x 21"D x 19.5"H | <table border="1"> <thead> <tr> <th>OPTION</th> <th>PRICE</th> <th>CODE</th> </tr> </thead> <tbody> <tr> <td>Softer Seat Foam-Loveseat</td> <td>32.00</td> <td>SF</td> </tr> </tbody> </table> | OPTION | PRICE | CODE | Softer Seat Foam-Loveseat | 32.00 | SF |
|---|---|--|--------|-------|------|---------------------------|-------|----|
| OPTION | PRICE | CODE | | | | | | |
| Softer Seat Foam-Loveseat | 32.00 | SF | | | | | | |

7443 Sofa

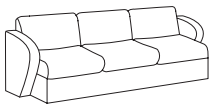

FREIGHT CLASS: 250
CUBIC FT: 53
SHIP WEIGHT: 160

QS NOW

83" W X 28.5" D X 30" H St. Yardage: 11

Grade	1	2	3	4	5	6	7	8	9	10	L	LL
Zone 1	2653	2922	3196	3319	3529	3812	3919	4372	4653	5003	5785	6331
Zone 2	2693	2966	3244	3369	3582	3869	3978	4438	4723	5078	5872	6426
Zone 3	2733	3010	3292	3419	3635	3926	4037	4503	4793	5153	5959	6521

- | <ul style="list-style-type: none"> • Fully upholstered • Ships fully assembled • Can be reconfigured | <ul style="list-style-type: none"> • See features in series overview • Seat: 74"W x 21"D x 19.5"H | <table border="1"> <thead> <tr> <th>OPTION</th> <th>PRICE</th> <th>CODE</th> </tr> </thead> <tbody> <tr> <td>Softer Seat Foam-Sofa</td> <td>48.00</td> <td>SF</td> </tr> </tbody> </table> | OPTION | PRICE | CODE | Softer Seat Foam-Sofa | 48.00 | SF |
|---|---|--|--------|-------|------|-----------------------|-------|----|
| OPTION | PRICE | CODE | | | | | | |
| Softer Seat Foam-Sofa | 48.00 | SF | | | | | | |

FINISH SELECTION

ASPEN **AP** | BLACK **BLK** | BOARDWALK **BW** | DRIFTWOOD **DW** | ESPRESSO **ESP** |
 HONEY CHERRY **HCY** | MAHOGANY **MAH** | MOAB **MOB** | NATURAL **FM** |
 ROUGE MAHOGANY **RM** | WINDSOR CHERRY **WC** | SHORELINE **SL** |

SIN 711-17 **HIMALAYA**

CONTEMPORARY

A Metropolitan Style

Himalaya reception, executive and guest seating present unique, contemporary solutions for every area of a commercial environment. From lobbies and lounges to conference rooms and private offices, Himalaya offers a consistent, metropolitan style in a design based on modern classics. All models available in full-relief, back-relief and solid (no-relief) versions.



Himalaya Details

- Relief-upholstered seat/back
- Square pattern stitch design
- Double-needle tailoring
- Extra-thick, ultracell seat foam
- Wood finish legs
- Metal legs available, add *MET* to item number, and add 5% up-charge to price amount

Power Option

Power modules can be installed in arms or in front. See page 135.

Relief Stitching Order Information

- **Full Relief:** standard
- **Back Relief:** add **SB** to model number
- **Solid:** add **SN** to model number



STANDARD ORDER: SPECIFICATION DETAIL

151	SB	SF	WC	PATTERN & COLOR
Base Model	OPT ONAL Stitching Relief	OPT ONAL High-Density Sea	Leg inish Selec ion	abric/Lea her Selec ion

Himalaya

151 Club Chair

32" W X 31" D X 30" H St. Yardage: 6.25 Seat & Back Ydg: 3.5 Arms Ydg: 3

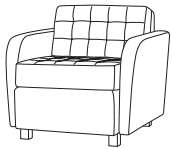

FREIGHT CLASS: 250
 CUBIC FT: 29
 SHIP WEIGHT: 81

Grade	1	2	3	4	5	6	7	8	9	10	L	LL
Zone 1	2006	2223	2421	2552	2726	2793	3074	3250	3468	3883	4493	4866
Zone 2	2036	2256	2457	2590	2767	2835	3120	3299	3520	3941	4560	4939
Zone 3	2066	2290	2494	2629	2808	2877	3166	3348	3572	3999	4628	5012

- Relief-upholstered seat/back
- Square pattern stitch design
- Double-needle tailoring
- Extra-thick, ultracell seat foam
- Loose-appearance, fixed cushions
- Wood finish legs
- Seat: 24"W x 21.5"D x 18.5"H

OPTION	PRICE	CODE
Softer Seat Foam-Chair	16.00	SF

QS NOW

152 Loveseat

56.5" W X 31" D X 30" H St. Yardage: 9.5 Seat & Back Ydg: 6.75 Arms Ydg: 3

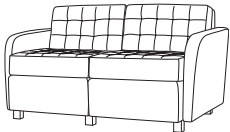

FREIGHT CLASS: 250
 CUBIC FT: 42
 SHIP WEIGHT: 117

Grade	1	2	3	4	5	6	7	8	9	10	L	LL
Zone 1	2906	3340	3734	3959	4295	4427	4969	5306	5728	6527	7872	8306
Zone 2	2950	3390	3790	4018	4359	4493	5044	5386	5814	6625	7990	8431
Zone 3	2993	3440	3846	4078	4424	4560	5118	5465	5900	6723	8108	8555

- Relief-upholstered seat/back
- Square pattern stitch design
- Double-needle tailoring
- Extra-thick, ultracell seat foam
- Loose-appearance, fixed cushions
- Wood finish legs
- Seat: 49"W x 21.5"D x 18.5"H

OPTION	PRICE	CODE
Softer Seat Foam-Loveseat	32.00	SF

QS NOW

153 Sofa

81" W X 31" D X 30" H St. Yardage: 13 Seat & Back Ydg: 10.5 Arms Ydg: 3

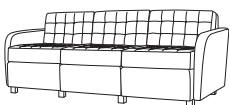

FREIGHT CLASS: 250
 CUBIC FT: 55
 SHIP WEIGHT: 157

Grade	1	2	3	4	5	6	7	8	9	10	L	LL
Zone 1	3700	4295	4842	5122	5578	5754	6488	6944	7512	8595	10539	11040
Zone 2	3756	4359	4915	5199	5662	5840	6585	7048	7625	8724	10697	11206
Zone 3	3811	4424	4987	5276	5745	5927	6683	7152	7737	8853	10855	11371

- Relief-upholstered seat/back
- Square pattern stitch design
- Double-needle tailoring
- Extra-thick, ultracell seat foam
- Loose-appearance, fixed cushions
- Wood finish legs
- Seat: 73"W x 21.5"D x 18.5"H

OPTION	PRICE	CODE
Softer Seat Foam-Sofa	48.00	SF

QS NOW

154 Lounge Chair, Armless



FREIGHT CLASS: 250
 CUBIC FT: 29
 SHIP WEIGHT: 51

QS NOW

25" W X 31" D X 30" H

St. Yardage: 4

Grade	1	2	3	4	5	6	7	8	9	10	L	LL
Zone 1	1758	1897	2021	2091	2196	2238	2408	2514	2646	2899	3305	3494
Zone 2	1784	1925	2051	2122	2229	2272	2444	2552	2686	2942	3355	3546
Zone 3	1811	1954	2082	2154	2262	2305	2480	2589	2725	2986	3404	3599

- Relief-upholstered seat/back
- Square pattern stitch design
- Double-needle tailoring
- Extra-thick, ultracell seat foam
- Loose-appearance, fixed cushions
- Wood finish legs
- Seat: 24.5"W x 21.5"D x 18.5"H

OPTION	PRICE	CODE
Softer Seat Foam-Chair	16.00	SF

155 Two-Seat Lounge, Armless

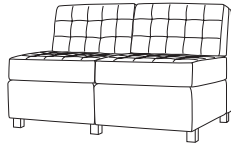

FREIGHT CLASS: 250
 CUBIC FT: 42
 SHIP WEIGHT: 90

QS NOW

50" W X 31" D X 30" H

St. Yardage: 7

Grade	1	2	3	4	5	6	7	8	9	10	L	LL
Zone 1	2574	2871	3126	3237	3450	3531	3874	4087	4351	4854	5791	6048
Zone 2	2613	2914	3173	3286	3502	3584	3932	4148	4416	4927	5878	6139
Zone 3	2651	2957	3220	3334	3554	3637	3990	4210	4482	5000	5965	6229

- Relief-upholstered seat/back
- Square pattern stitch design
- Double-needle tailoring
- Extra-thick, ultracell seat foam
- Loose-appearance, fixed cushions
- Wood finish legs
- Seat: 49"W x 21.5"D x 18.5"H

OPTION	PRICE	CODE
Softer Seat Foam-Loveseat	32.00	SF

156 Three-Seat Lounge, Armless

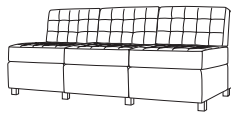

FREIGHT CLASS: 250
 CUBIC FT: 54
 SHIP WEIGHT: 128

QS NOW

74" W X 31" D X 30" H

St. Yardage: 10.5

Grade	1	2	3	4	5	6	7	8	9	10	L	LL
Zone 1	3277	3721	4105	4270	4588	4710	5226	5542	5939	6695	8188	8485
Zone 2	3326	3777	4167	4334	4657	4781	5304	5625	6028	6795	8311	8612
Zone 3	3375	3833	4228	4398	4726	4851	5383	5708	6117	6896	8434	8740

- Relief-upholstered seat/back
- Square pattern stitch design
- Double-needle tailoring
- Extra-thick, ultracell seat foam
- Loose-appearance, fixed cushions
- Wood finish legs
- Seat: 73"W x 21.5"D x 18.5"H

OPTION	PRICE	CODE
Softer Seat Foam-Sofa	48.00	SF

157 4' Bench

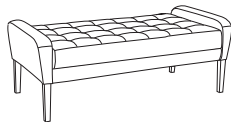

FREIGHT CLASS: 150
 CUBIC FT: 13
 SHIP WEIGHT: 43

QS NOW

48" W X 18" D X 19.25" H

St. Yardage: 3

Grade	1	2	3	4	5	6	7	8	9	10	L	LL
Zone 1	1532	1580	1652	1739	1805	1881	1925	2067	2153	2263	2664	2961
Zone 2	1555	1604	1677	1765	1832	1909	1954	2098	2185	2297	2704	3005
Zone 3	1578	1627	1702	1791	1859	1937	1983	2129	2218	2331	2744	3050

- Relief-upholstered seat
- Square pattern stitch design
- Double-needle tailoring
- Extra-thick, high-density foam
- Solid wood legs
- Seat: 43"W x 17.5"D x 18"H

OPTION	PRICE	CODE
Softer Seat Foam-Loveseat	32.00	SF

158 6' Bench

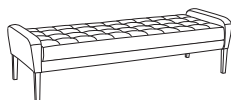

FREIGHT CLASS: 150
 CUBIC FT: 25
 SHIP WEIGHT: 75

QS NOW

72" W X 24" D X 19.25" H

St. Yardage: 4

Grade	1	2	3	4	5	6	7	8	9	10	L	LL
Zone 1	1953	2016	2112	2223	2324	2430	2487	2679	2797	2946	3442	3894
Zone 2	1982	2046	2144	2256	2359	2466	2524	2719	2839	2990	3494	3952
Zone 3	2012	2076	2175	2290	2394	2503	2562	2759	2881	3034	3545	4011

- Relief-upholstered seat
- Square pattern stitch design
- Double-needle tailoring
- Extra-thick, high-density foam
- Solid wood legs
- Seat: 64"W x 23.5"D x 18"H

OPTION	PRICE	CODE
Softer Seat Foam-Sofa	48.00	SF

FINISH SELECTION

ASPEN **AP** | BLACK **BLK** | BOARDWALK **BW** | DRIFTWOOD **DW** | ESPRESSO **ESP** |
 HONEY CHERRY **HCY** | MAHOGANY **MAH** | MOAB **MOB** | NATURAL **FM** |
 ROUGE MAHOGANY **RM** | WINDSOR CHERRY **WC** | SHORELINE **SL** |

CONTEMPORARY

143 Arm Chair



FREIGHT CLASS: 300
 CUBIC FT: 15
 SHIP WEIGHT: 27

22.75" W X 26" D X 33.5" H St. Yardage: 1.75

Grade	1	2	3	4	5	6	7	8	9	10	L	LL
Zone 1	1092	1180	1256	1287	1348	1372	1474	1535	1614	1762	2041	2112
Zone 2	1108	1198	1275	1306	1368	1393	1496	1558	1638	1788	2072	2144
Zone 3	1125	1215	1294	1326	1388	1413	1518	1581	1662	1815	2102	2175

- Exposed legs and arms are solid hardwood
- Square pattern stitching with hand pulled reliefs
- Specify wood finish
- Seat: 19"W x 18"D x 19"H

OPTION	PRICE	CODE
Softer Seat Foam-Chair	16.00	SF

QS **NOW**

144 Armless Side Chair



FREIGHT CLASS: 300
 CUBIC FT: 15
 SHIP WEIGHT: 25

19.5" W X 26" D X 33.5" H St. Yardage: 1.75

Grade	1	2	3	4	5	6	7	8	9	10	L	LL
Zone 1	1049	1096	1211	1246	1307	1332	1431	1495	1571	1720	1976	2071
Zone 2	1065	1112	1229	1265	1327	1352	1452	1517	1595	1746	2006	2102
Zone 3	1080	1129	1247	1283	1346	1372	1474	1540	1618	1772	2035	2133

- Exposed legs and arms are solid hardwood
- Square pattern stitching with hand pulled reliefs
- Specify wood finish
- Seat: 19"W x 18"D x 19"H

OPTION	PRICE	CODE
Softer Seat Foam-Chair	16.00	SF

QS **NOW**

Dramatic Curves

We believe that a seat can, and should, combine both form and function. For **Claudia**, we put special emphasis on the form. Take a seat and your arms will naturally fall into the gently undulating contour of the fully upholstered arms. Brightly polished aluminum legs add just the right amount of sparkle and visual interest.

Claudia Details

- Angled satin finish chrome legs with stationary feet
- Taut-upholstery
- No-sag sinuous wire spring seat and back suspensions
- Coordinating cocktail and end table

Two-Color Fabric Combination

- Contrasting fabric combinations are available. To order, please add the Seat/Back Fabric pattern and color, followed by Arm Fabric pattern and color to the model number.
- Unit invoiced at the highest fabric price grade featured on the unit

Power Option

Power modules can be installed in front or in side. See page 135.



Claudia

5301 Club Chair

33.5" W X 31" D X 32.5" H

St. Yardage: 5.75

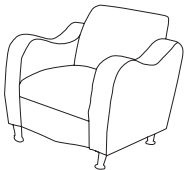

FREIGHT CLASS: 250
CUBIC FT: 31
SHIP WEIGHT: 101

Grade	1	2	3	4	5	6	7	8	9	10	L	LL
Zone 1	1470	1574	1680	1840	1957	2112	2174	2424	2580	2777	2898	3261
Zone 2	1492	1598	1705	1868	1986	2144	2207	2460	2619	2819	2941	3310
Zone 3	1514	1621	1730	1895	2016	2175	2239	2497	2657	2860	2985	3359

- Gently contoured fully upholstered arms
- Angled satin finished chrome legs with stationary feet
- Soft foam seat is standard
- Extra-thick, high-density foam cushions
- Seat: 21"W x 21"D x 19"H

QS NOW

5302 Loveseat

56.5" W X 31" D X 32.5" H

St. Yardage: 8

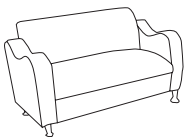

FREIGHT CLASS: 250
CUBIC FT: 57
SHIP WEIGHT: 125

Grade	1	2	3	4	5	6	7	8	9	10	L	LL
Zone 1	2101	2232	2365	2537	2738	2939	3207	3368	3526	3743	3899	4640
Zone 2	2133	2265	2400	2575	2779	2983	3255	3419	3579	3799	3957	4710
Zone 3	2164	2299	2436	2613	2820	3027	3303	3469	3632	3855	4016	4779

- Gently contoured fully upholstered arms
- Angled satin finished chrome legs with stationary feet
- Soft foam seat is standard
- Extra-thick, high-density foam cushions
- Seat: 43.5"W x 21"D x 19"H

QS NOW

5303 Sofa

78.5" W X 31" D X 32.5" H

St. Yardage: 10

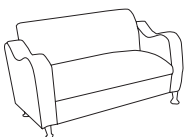

FREIGHT CLASS: 250
CUBIC FT: 75
SHIP WEIGHT: 162

Grade	1	2	3	4	5	6	7	8	9	10	L	LL
Zone 1	2944	3101	3260	3552	3832	4113	4257	4692	4861	5006	5113	5848
Zone 2	2988	3148	3309	3605	3889	4175	4321	4762	4934	5081	5190	5936
Zone 3	3032	3194	3358	3659	3947	4236	4385	4833	5007	5156	5266	6023

- Gently contoured fully upholstered arms
- Angled satin finished chrome legs with stationary feet
- Soft foam seat is standard
- Extra-thick, high-density foam cushions
- Seat: 65.5"W x 21"D x 19"H

QS NOW

HW_CT48 Coffee Table

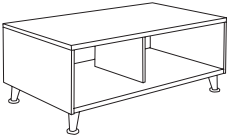

- Open storage/display shelf and top
- Angled satin finish chrome legs with stationary feet to match Claudia series
- Ships fully assembled

FREIGHT CLASS: 150

		Zone Pricing		
		1	2	3
48"W x 24"D x 18"H	Cubic Ft: 11.9 Ship Weight: 96	781	793	804
Finish Options: Natural Maple (FM), Windsor Cherry (WC), Mahogany (M), Graphite (GP), Black (E), Espresso (X), Boardwalk (BW), Driftwood (DW), Shoreline (SL)		SIN #711-11		

HW_ET18 End Table

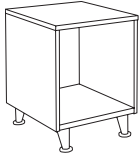

- Open storage/display shelf and top
- Angled satin finish chrome legs with stationary feet to match Claudia series
- Ships fully assembled

FREIGHT CLASS: 150

18"W x 22"D x 24"H	Cubic Ft: 6.5 Ship Weight: 50	608	617	626
Finish Options: Natural Maple (FM), Windsor Cherry (WC), Mahogany (M), Graphite (GP), Black (E), Espresso (X), Boardwalk (BW), Driftwood (DW), Shoreline (SL)		SIN #711-11		

Claudia Oval Tables

5321 Oval Table, Floating Laminate Top

42.5" W X 21.5" D X 19.25" H St. Yardage: 4.5

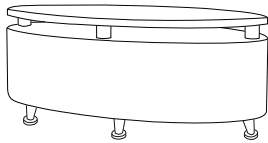

FREIGHT CLASS: 175
CUBIC FT: 26
SHIP WEIGHT: 64

Grade	1	2	3	4	5	6	7	8	9	10	L	LL
Zone 1	1390	1466	1553	1625	1701	1800	1898	1998	2096	2221	2455	3012
Zone 2	1411	1488	1576	1649	1727	1827	1926	2028	2127	2254	2492	3057
Zone 3	1432	1510	1600	1674	1752	1854	1955	2058	2159	2288	2529	3102

- 1" thick thermally fused laminate tops available in all Hyperwork finishes
- Middle section of table is fully upholstered
- 2" anodized aluminum spacers create a floating top
- Angled satin finish chrome legs with stationary feet

QS NOW

5322 Oval Table, Laminate Top

42.5" W X 21.5" D X 17.25" H St. Yardage: 4.5

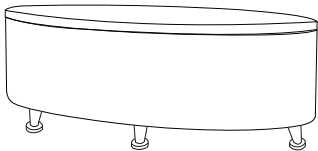

FREIGHT CLASS: 175
CUBIC FT: 26
SHIP WEIGHT: 63

Grade	1	2	3	4	5	6	7	8	9	10	L	LL
Zone 1	1358	1431	1519	1593	1667	1766	1865	1964	2063	2187	2423	2980
Zone 2	1378	1452	1542	1617	1692	1792	1893	1993	2094	2220	2459	3025
Zone 3	1399	1474	1565	1641	1717	1819	1921	2023	2125	2253	2496	3069

- 1" thick thermally fused laminate tops available in all Hyperwork finishes
- Middle section of table is fully upholstered
- Angled satin finish chrome legs with stationary feet

QS NOW

5326 Oval Table, Fully Upholstered

42.5" W X 21.5" D X 17.25" H St. Yardage: 4.5

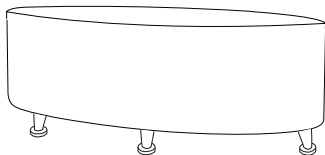

FREIGHT CLASS: 175
CUBIC FT: 26
SHIP WEIGHT: 63

Grade	1	2	3	4	5	6	7	8	9	10	L	LL
Zone 1	1159	1233	1319	1394	1469	1567	1666	1766	1865	1988	2224	2781
Zone 2	1176	1251	1339	1415	1491	1591	1691	1792	1893	2018	2257	2823
Zone 3	1194	1270	1359	1436	1513	1614	1716	1819	1921	2048	2291	2864

- Fully upholstered
- Angled satin finish chrome legs with stationary feet

QS NOW

5336 Round Table, Laminate Top

36" W X 36" D X 22" H St. Yardage: 4.5

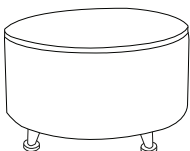

FREIGHT CLASS: 175
CUBIC FT: 41.5
SHIP WEIGHT: 135

Grade	1	2	3	4	5	6	7	8	9	10	L	LL
Zone 1	1667	1736	1814	1882	1951	2041	2131	2222	2312	2424	2639	3147
Zone 2	1692	1762	1841	1910	1980	2072	2163	2255	2347	2460	2679	3194
Zone 3	1717	1788	1868	1938	2010	2102	2195	2289	2381	2497	2718	3241

- 1" thick thermally fused laminate tops available in all Hyperwork finishes
- Middle section of table is fully upholstered
- Angled satin finish chrome legs with stationary feet

QS NOW

Art Deco Influences

The **Lauren Collection** of seating and occasional tables blends Art Deco influences with a versatile design applicable from offices to public, waiting room, hospitality and healthcare environments.

Lauren Details

- Taut seat, no-sag springs
- High density foam adds comfort
- Stitching between sections of seat and back cushions on loveseat and sofa units only if required by upholstery application, topped vs. railroad.
- Coordinating cocktail and end table
- Wood finish legs

Optional BAM Foot Available

- Truncated BAM foot design increases contact with floor. Recommended for high-use areas.
- Available in Black finish only.
- Add \$53 upcharge
- To specify BAM foot, add BAM to the end of the model number.



Power Option

Power modules can be installed in front only. See page 135.



Lauren

6101 Club Chair

36" W X 32.5" D X 34" H

St. Yardage: 6.25

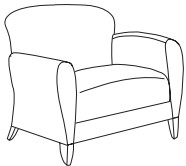

FREIGHT CLASS: 250
CUBIC FT: 31
SHIP WEIGHT: 81

Grade	1	2	3	4	5	6	7	8	9	10	L	LL
Zone 1	1971	2202	2401	2516	2691	2758	3039	3214	3432	3848	4703	4829
Zone 2	2001	2235	2437	2554	2731	2799	3085	3262	3483	3906	4774	4901
Zone 3	2030	2268	2473	2591	2772	2841	3130	3310	3535	3963	4844	4974

- Wood legs in finishes listed above
- Tight seat over no-sag springs
- High density foam seat and back cushions
- Seat: 22"W x 21 5"D x 19"H

OPTION	PRICE	CODE
Softer Seat Foam-Chair	16.00	SF
Black BAM Feet	53.00	BAM

QS NOW

6102 Loveseat

58" W X 32.5" D X 34" H

St. Yardage: 7.5

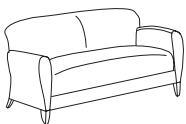

FREIGHT CLASS: 250
CUBIC FT: 60
SHIP WEIGHT: 113

Grade	1	2	3	4	5	6	7	8	9	10	L	LL
Zone 1	2611	2897	3138	3275	3486	3569	3910	4123	4388	4891	5709	6084
Zone 2	2650	2940	3185	3324	3538	3623	3969	4185	4454	4964	5795	6175
Zone 3	2689	2984	3232	3373	3591	3676	4027	4247	4520	5038	5880	6267

- Wood legs in finishes listed above
- Tight seat over no-sag springs
- High density foam seat and back cushions
- Seat: 45"W x 21 5"D x 19"H

OPTION	PRICE	CODE
Softer Seat Foam-Loveseat	32.00	SF
Black BAM Feet	53.00	BAM

QS NOW

6103 Sofa

80" W X 32.5" D X 34" H

St. Yardage: 10

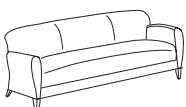

FREIGHT CLASS: 250
CUBIC FT: 77
SHIP WEIGHT: 138

Grade	1	2	3	4	5	6	7	8	9	10	L	LL
Zone 1	3265	3626	3945	4142	4425	4531	4696	4985	5266	5617	6856	7345
Zone 2	3314	3680	4004	4204	4491	4599	4766	5060	5345	5701	6959	7455
Zone 3	3363	3735	4063	4266	4558	4667	4837	5135	5424	5786	7062	7565

- Wood legs in finishes listed above
- Tight seat over no-sag springs
- High density foam seat and back cushions
- Seat: 67"W x 21 5"D x 19"H

OPTION	PRICE	CODE
Softer Seat Foam-Sofa	48.00	SF
Black BAM Feet	53.00	BAM

QS NOW

Award Winning

Award-winning reception seating, **Rebecca** features an elegant, flared-arm design popular in many environments and applications.



Rebecca Details

- Taut seat, no-sag springs
- High density foam adds comfort
- Stitching between sections of seat and back cushions on loveseat and sofa units only if required by upholstery application, topped vs. railroad
- Coordinating cocktail and end table
- Wood finish legs

Optional BAM Foot Available

- Truncated BAM foot design increases contact with floor. Recommended for high-use areas.
- Available in Black finish only.
- Add \$53 upcharge
- To specify BAM foot, add BAM to the end of the model number.



Power Option

Power modules can be installed in front only. See page 135.

Rebecca

6201 Club Chair

38" W X 32.5" D X 34.5" H

St. Yardage: 5.75

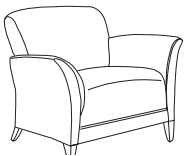

FREIGHT CLASS: 250
CUBIC FT: 31
SHIP WEIGHT: 72

Grade	1	2	3	4	5	6	7	8	9	10	L	LL
Zone 1	1971	2202	2401	2516	2691	2758	3039	3214	3432	3848	4703	4829
Zone 2	2001	2235	2437	2554	2731	2799	3085	3262	3483	3906	4774	4901
Zone 3	2030	2268	2473	2591	2772	2841	3130	3310	3535	3963	4844	4974

- Wood legs in finishes listed above
- High density foam seat and back cushions
- Tight seat over no-sag springs
- Seat: 23"W x 22"D x 19"H

OPTION	PRICE	CODE
Softer Seat Foam-Chair	16.00	SF
Black BAM Feet	53.00	BAM

QS NOW

6202 Loveseat

59" W X 32.5" D X 34.5" H

St. Yardage: 7

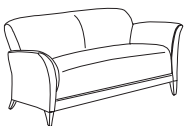

FREIGHT CLASS: 250
CUBIC FT: 60
SHIP WEIGHT: 113

Grade	1	2	3	4	5	6	7	8	9	10	L	LL
Zone 1	2611	2897	3138	3275	3486	3569	3910	4123	4388	4891	5709	6084
Zone 2	2650	2940	3185	3324	3538	3623	3969	4185	4454	4964	5795	6175
Zone 3	2689	2984	3232	3373	3591	3676	4027	4247	4520	5038	5880	6267

- Wood legs in finishes listed above
- High density foam seat and back cushions
- Tight seat over no-sag springs
- Seat: 44.25"W x 22"D x 19"H

OPTION	PRICE	CODE
Softer Seat Foam-Loveseat	32.00	SF
Black BAM Feet	53.00	BAM

QS NOW

6203 Sofa

81.5" W X 32.5" D X 34.5" H

St. Yardage: 9.5

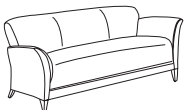

FREIGHT CLASS: 250
CUBIC FT: 77
SHIP WEIGHT: 138

Grade	1	2	3	4	5	6	7	8	9	10	L	LL
Zone 1	3265	3626	3945	4142	4425	4531	4696	4985	5266	5617	6856	7345
Zone 2	3314	3680	4004	4204	4491	4599	4766	5060	5345	5701	6959	7455
Zone 3	3363	3735	4063	4266	4558	4667	4837	5135	5424	5786	7062	7565

- Wood legs in finishes listed above
- High density foam seat and back cushions
- Tight seat over no-sag springs
- Seat: 66.5"W x 22"D x 19"H

OPTION	PRICE	CODE
Softer Seat Foam-Sofa	48.00	SF
Black BAM Feet	53.00	BAM

QS NOW

FINISH SELECTION

ASPEN **AP** | BLACK **BLK** | BOARDWALK **BW** | DRIFTWOOD **DW** | ESPRESSO **ESP** | HONEY CHERRY **HCY** | MAHOGANY **MAH** | MOAB **MOB** | NATURAL **FM** | ROUGE MAHOGANY **RM** | WINDSOR CHERRY **WC** | SHORELINE **SL** |

SIN 711-16 **SCARLET**

CONTEMPORARY

Impressive Seating

From hospitality to healthcare to educational and corporate environments, the **Scarlet Collection** presents a distinctive scroll-arm design, creating impressive lounges, lobbies and other sitting areas.

Scarlet Details

- Taut seat, no-sag springs
- High density foam adds comfort
- Stitching between sections of seat and back cushions on loveseat and sofa units only if required by upholstery application, topped vs. railroad
- Coordinating cocktail and end table
- Wood finish legs

Optional BAM Foot Available

- Truncated BAM foot design increases contact with floor. Recommended for high-use areas.
- Available in Black finish only.
- Add \$53 upcharge
- To specify BAM foot, add BAM to the end of the model number.



Power Option

Power modules can be installed in front only. See page 135.

Scarlet

6301 Club Chair

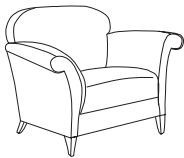

FREIGHT CLASS: 250
CUBIC FT: 31
SHIP WEIGHT: 74

38" W X 32.5" D X 34.5" H St. Yardage: 6.5

Grade	1	2	3	4	5	6	7	8	9	10	L	LL
Zone 1	2175	2413	2625	2759	2947	3019	3321	3623	3855	4228	4530	5103
Zone 2	2208	2449	2664	2800	2991	3064	3371	3677	3913	4291	4598	5180
Zone 3	2240	2485	2704	2842	3035	3110	3421	3732	3971	4355	4666	5256

- Wood legs in finishes listed above
- Tight seat over no-sag springs
- High density foam seat and back cushions
- Scroll arm and box welted back design
- Seat: 21" W x 22" D x 19" H

OPTION	PRICE	CODE
Softer Seat Foam-Chair	16.00	SF
Black BAM Feet	53.00	BAM

QS NOW

6302 Loveseat

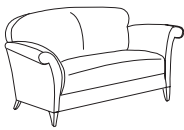

FREIGHT CLASS: 250
CUBIC FT: 60
SHIP WEIGHT: 113

59" W X 32.5" D X 34.5" H St. Yardage: 8

Grade	1	2	3	4	5	6	7	8	9	10	L	LL
Zone 1	2867	3163	3414	3548	3766	3851	4203	4422	4695	4984	6052	6440
Zone 2	2910	3210	3465	3601	3822	3909	4266	4488	4765	5059	6143	6537
Zone 3	2953	3258	3516	3654	3879	3967	4329	4555	4836	5134	6234	6633

- Wood legs in finishes listed above
- Tight seat over no-sag springs
- High density foam seat and back cushions
- Scroll arm and box welted back design
- Seat: 44" W x 22" D x 19" H

OPTION	PRICE	CODE
Softer Seat Foam-Loveseat	32.00	SF
Black BAM Feet	53.00	BAM

QS NOW

6303 Sofa

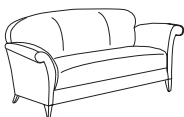

FREIGHT CLASS: 250
CUBIC FT: 77
SHIP WEIGHT: 138

81" W X 32.5" D X 34.5" H St. Yardage: 10.5

Grade	1	2	3	4	5	6	7	8	9	10	L	LL
Zone 1	3587	3951	4274	4464	4744	4853	5026	5306	5588	5937	6604	7695
Zone 2	3641	4010	4338	4531	4815	4926	5101	5386	5672	6026	6703	7810
Zone 3	3695	4070	4402	4598	4886	4999	5177	5465	5756	6115	6802	7926

- Wood legs in finishes listed above
- Tight seat over no-sag springs
- High density foam seat and back cushions
- Scroll arm and box welted back design
- Seat: 66.5" W x 22" D x 19" H

OPTION	PRICE	CODE
Softer Seat Foam-Sofa	48.00	SF
Black BAM Feet	53.00	BAM

QS NOW

Sophisticated Form

Kimberly Collection blends sophisticated form with careful attention to details such as soft arm pleats and welted design lines for an elegant, fully upholstered reception seating solution that includes occasional tables.

Kimberly Details

- Taut seat, no-sag springs
- High density foam adds comfort
- Stitching between sections of seat and back cushions on loveseat and sofa units only if required by upholstery application, topped vs. railroad
- Coordinating cocktail and end table
- Wood finish legs

Optional BAM Foot Available

- Truncated BAM foot design increases contact with floor. Recommended for high-use areas.
- Available in Black finish only.
- Add \$53 upcharge
- To specify BAM foot, add **BAM** to the end of the model number.



Power Option

Power modules can be installed in front only. See page 135.



Kimberly

6401 Club Chair

37.5" W X 32.5" D X 35" H

St. Yardage: 6.25

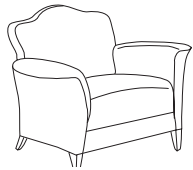

FREIGHT CLASS: 250
CUBIC FT: 31
SHIP WEIGHT: 75

Grade	1	2	3	4	5	6	7	8	9	10	L	LL
Zone 1	2175	2413	2625	2759	2947	3019	3321	3623	3855	4228	4530	5103
Zone 2	2208	2449	2664	2800	2991	3064	3371	3677	3913	4291	4598	5180
Zone 3	2240	2485	2704	2842	3035	3110	3421	3732	3971	4355	4666	5256

- Wood legs in finishes listed above
- Flared welted arm design
- Camel style welted back
- Seat: 22.5"W x 22"D x 19"H

SIN #711-16

OPTION	PRICE	CODE
Softer Seat Foam-Chair	16.00	SF
Black BAM Feet	53.00	BAM

QS NOW

6402 Loveseat

58" W X 32.5" D X 35" H

St. Yardage: 8

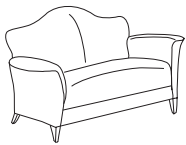

FREIGHT CLASS: 250
CUBIC FT: 60
SHIP WEIGHT: 116

Grade	1	2	3	4	5	6	7	8	9	10	L	LL
Zone 1	2867	3163	3414	3548	3766	3851	4203	4422	4695	4984	6052	6440
Zone 2	2910	3210	3465	3601	3822	3909	4266	4488	4765	5059	6143	6537
Zone 3	2953	3258	3516	3654	3879	3967	4329	4555	4836	5134	6234	6633

- Wood legs in finishes listed above
- Flared welted arm design
- Camel style welted back
- Seat: 43.5"W x 22"D x 19"H

SIN #711-16

OPTION	PRICE	CODE
Softer Seat Foam-Loveseat	32.00	SF
Black BAM Feet	53.00	BAM

QS NOW

6403 Sofa

81" W X 32.5" D X 35" H

St. Yardage: 10

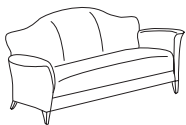

FREIGHT CLASS: 250
CUBIC FT: 76
SHIP WEIGHT: 153

Grade	1	2	3	4	5	6	7	8	9	10	L	LL
Zone 1	3587	3951	4274	4464	4744	4853	5026	5306	5588	5937	6604	7695
Zone 2	3641	4010	4338	4531	4815	4926	5101	5386	5672	6026	6703	7810
Zone 3	3695	4070	4402	4598	4886	4999	5177	5465	5756	6115	6802	7926

- Wood legs in finishes listed above
- Flared welted arm design
- Camel style welted back
- Seat: 67"W x 22"D x 19"H

SIN #711-16

OPTION	PRICE	CODE
Softer Seat Foam-Sofa	48.00	SF
Black BAM Feet	53.00	BAM

QS NOW

FINISH SELECTION

ASPEN **AP** | BLACK **BLK** | BOARDWALK **BW** | DRIFTWOOD **DW** | ESPRESSO **ESP** | HONEY CHERRY **HCY** | MAHOGANY **MAH** | MOAB **MOB** | NATURAL **FM** | ROUGE MAHOGANY **RM** | WINDSOR CHERRY **WC** | SHORELINE **SL** |

SIN VARIOUS **KIMBERLY**

CONTEMPORARY

6400 Ottoman

31" W X 20.5" D X 17.5" H

St. Yardage: 2.5

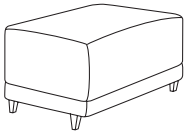

Grade	1	2	3	4	5	6	7	8	9	10	L	LL
Zone 1	746	833	905	942	970	1003	1028	1127	1190	1268	1416	1756
Zone 2	757	845	919	956	985	1018	1043	1144	1208	1287	1437	1782
Zone 3	768	858	932	970	999	1033	1059	1161	1226	1306	1458	1809

- Wood legs
- High density foam

SIN #711-16

OPTION	PRICE	CODE
Self-Locking Casters	85.00	S
Softer Seat Foam-Chair	16.00	SF
Black BAM Feet	53.00	BAM
Accompany Metal Legs	90.00	MET

FREIGHT CLASS: 150

CUBIC FT: 15

SHIP WEIGHT: 42

QS NOW

6720 Cocktail Table, Wood Veneer Top

- Solid hardwood legs
- Veneer top
- Available in all seating finishes
- Assembly required

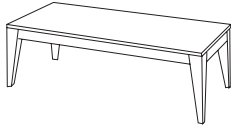

FREIGHT CLASS: 85

QS

	Zone Pricing	1	2	3
54"W x 24"D x 16"H Cubic Ft: 5 Ship Weight: 55		1187	1205	1223
SIN #711-11				

6723 End Table, Wood Veneer Top

- Solid hardwood legs
- Veneer top
- Available in all seating finishes
- Assembly required



FREIGHT CLASS: 85

QS

	Zone Pricing	1	2	3
24"W x 28"D x 20"H Cubic Ft: 3 Ship Weight: 40		882	895	908
SIN #711-11				

TRANSITIONAL

Luxurious Comfort, Curved Wood Accent

9100 Lounge Seating provides luxurious comfort with a unique, compound-curved wood accent. Flare arm design, contoured lumbar support and generous scale create comfortable proportion and relaxed seating. Seat cushions feature extra-thick, multi-density foam for support and are removable for easy cleaning.



9100 Series Features

- Flare arm design with wood accent
- Extra-thick, multi-density foam
- Generous scale
- Coordinating occasional tables feature veneer tops and the natural beauty of wood

Power Option

Power modules can be installed in front only. See page 135.



9100 Series

9131 Lounge Chair

35" W X 35" D X 29" H

St. Yardage: 5.75



FREIGHT CLASS: 250
 CUBIC FT: 24
 SHIP WEIGHT: 79

QS NOW

Grade	1	2	3	4	5	6	7	8	9	10	L	LL
Zone 1	1972	2168	2340	2441	2590	2645	2889	2922	3224	3581	3849	4311
Zone 2	2002	2201	2375	2478	2629	2685	2932	2966	3272	3635	3907	4376
Zone 3	2031	2233	2410	2514	2668	2724	2976	3010	3321	3688	3964	4440

- Flared arms with curved hardwood accents
- Loose seat cushions with zipper access
- See features in series overview
- Seat: 24"W x 20.5"D x 19"H

OPTION	PRICE	CODE
Softer Seat Foam-Chair	16.00	SF
SIN #711-16		

9132 Loveseat

59" W X 35" D X 30" H

St. Yardage: 7.5

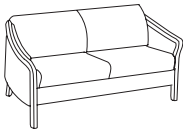

FREIGHT CLASS: 250
 CUBIC FT: 42
 SHIP WEIGHT: 105

QS NOW

Grade	1	2	3	4	5	6	7	8	9	10	L	LL
Zone 1	2776	3065	3294	3436	3648	3732	4074	4286	4551	5053	5788	6083
Zone 2	2818	3111	3343	3488	3703	3788	4135	4350	4619	5129	5875	6174
Zone 3	2859	3157	3393	3539	3757	3844	4196	4415	4688	5205	5962	6265

- Flared arms with curved hardwood accents
- Loose seat cushions with zipper access
- See features in series overview
- Seat: 48"W x 20.5"D x 19"H

OPTION	PRICE	CODE
Softer Seat Foam-Loveseat	32.00	SF
SIN #711-16		

9133 Sofa

83" W X 35" D X 30" H

St. Yardage: 9.5

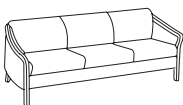

FREIGHT CLASS: 250
 CUBIC FT: 56
 SHIP WEIGHT: 138

QS NOW

Grade	1	2	3	4	5	6	7	8	9	10	L	LL
Zone 1	3478	3817	4121	4294	4558	4773	5081	5344	5671	6294	6963	7547
Zone 2	3530	3874	4183	4358	4626	4845	5157	5424	5756	6388	7067	7660
Zone 3	3582	3932	4245	4423	4695	4916	5233	5504	5841	6483	7172	7773

- Flared arms with curved hardwood accents
- Loose seat cushions with zipper access
- See features in series overview
- Seat: 72"W x 20.5"D x 19"H

OPTION	PRICE	CODE
Softer Seat Foam-Sofa	48.00	SF
SIN #711-16		

FINISH SELECTION

ASPEN **AP** | BLACK **BLK** | BOARDWALK **BW** | DRIFTWOOD **DW** | ESPRESSO **ESP** |
 HONEY CHERRY **HCY** | MAHOGANY **MAH** | MOAB **MOB** | NATURAL **FM** |
 ROUGE MAHOGANY **RM** | WINDSOR CHERRY **WC** | SHORELINE **SL** |

9138 Chair

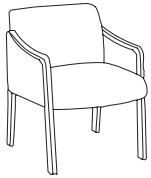

25" W X 27" D X 32.5" H

St. Yardage: 3

Grade	1	2	3	4	5	6	7	8	9	10	L	LL
Zone 1	1167	1275	1366	1420	1501	1533	1664	1745	1845	2039	2265	2432
Zone 2	1185	1294	1386	1441	1524	1556	1689	1771	1873	2070	2299	2468
Zone 3	1202	1313	1407	1463	1546	1579	1714	1797	1900	2100	2333	2505

FREIGHT CLASS: 250
 CUBIC FT: 15
 SHIP WEIGHT: 38

- Curved hardwood arms
- Upholstered arm inserts
- See features in series overview
- Seat: 20"W x 18.25"D x 20.25"H

OPTION	PRICE	CODE
Softer Seat Foam-Chair	16.00	SF

SIN #711-16

QS **NOW**

9120 Cocktail Table

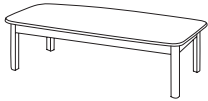

- Wood veneer top
- Solid hardwood legs
- Available in all seating finishes listed
- Ships assembled

FREIGHT CLASS: 150

	Zone Pricing	1	2	3
54"W X 24"D X 16.5"H	Cubic Ft: 16 Ship Weight: 65	1149	1166	1183

SIN #711-11

QS

9123 End Table

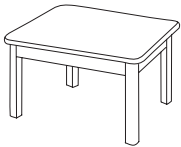

- Wood veneer top
- Solid hardwood legs
- Available in all seating finishes listed
- Ships assembled

FREIGHT CLASS: 150

24"W X 28"D X 20.25"H	Cubic Ft: 9 Ship Weight: 40	826	838	851
-----------------------	-----------------------------	------------	------------	------------

SIN #711-11

QS

Period Influence, Classic Style

Traditional Reception features period influences to create Wing Back, Gooseneck and other classic styles. Traditional tufting, individually-placed brass nail trim and shaped wood basecaps enhance the design.

Traditional Reception Details

- Brass nail trim
- Traditional tufting upholstery stitching is standard on all seating
- Occasional tables feature high-gloss, high-pressure laminate tops



4053 Goose Neck Arm Chair

Reception

4053 Goose Neck Arm Chair

25" W X 29" D X 43" H

St. Yardage: 3.5



Freight Class: 250
 Cubic Ft: 23
 Ship Weight: 48

Grade	1	2	3	4	5	6	7	8	9	10	L	LL
Zone 1	1823	1933	2037	2095	2182	2216	2358	2445	2553	2760	3190	3367
Zone 2	1850	1962	2068	2126	2215	2249	2393	2482	2591	2801	3238	3418
Zone 3	1878	1991	2098	2158	2247	2282	2429	2518	2630	2843	3286	3468

- Tufted seat and back
 - Goose neck arms
 - Queen Anne style legs
 - Seat: 18"W x 17.75"D x 19.5"H
- SIN 711-18

OPTION	PRICE	CODE
Non-Tufted Option	N/C	NT
Upholstered Arm Caps	114.00	UA

QS NOW

4054 Armless Side Chair

25" W X 29" D X 43" H

St. Yardage: 3.5



Freight Class: 250
 Cubic Ft: 23
 Ship Weight: 45

Grade	1	2	3	4	5	6	7	8	9	10	L	LL
Zone 1	1307	1365	1429	1514	1580	1667	1701	1841	1928	2038	2129	2623
Zone 2	1327	1385	1450	1537	1604	1692	1727	1869	1957	2069	2161	2662
Zone 3	1346	1406	1472	1559	1627	1717	1752	1896	1986	2099	2193	2702

- Tufted seat and back
 - Queen Anne style legs
 - Seat: 18"W x 17.75"D x 19.5"H
- SIN 711-18

OPTION	PRICE	CODE
Non-Tufted Option	N/C	NT

QS NOW

FINISH SELECTION

ASPEN AP | BLACK BLK | BOARDWALK BW | DRIFTWOOD DW | ESPRESSO ESP |
 HONEY CHERRY HCY | MAHOGANY MAH | MOAB MOB | ROUGE MAHOGANY RM |
 WINDSOR CHERRY WC |

SIN VARIOUS TRADITIONAL

TRADITIONAL

4072 Loveseat

57" W X 27.5" D X 34" H

St. Yardage: 6

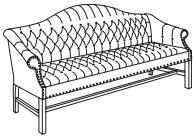

Freight Class: 250
 Cubic Ft: 36
 Ship Weight: 78

Grade	1	2	3	4	5	6	7	8	9	10	L	LL
Zone 1	2015	2243	2435	2541	2710	2776	3047	3215	3426	3824	4646	4887
Zone 2	2045	2277	2472	2579	2751	2818	3093	3263	3477	3881	4716	4960
Zone 3	2075	2310	2508	2617	2791	2859	3138	3311	3529	3939	4785	5034

OPTION	PRICE	CODE
No Brass Trim Option	N/C	NB
Non-Tufted Option	N/C	NT

- Tufted seat, back and inside arms
- Brass nail head trim on arms and seat
- Traditional scroll arm and camelback
- Chippendale style legs
- Cross rail adds leg support
- Seat: 47.5"W x 17.5"D x 19"H
- SIN 711-16

QS NOW

4073 Wing Back Arm Chair

27" W X 29" D X 39" H

St. Yardage: 4



Freight Class: 250
 Cubic Ft: 20
 Ship Weight: 48

Grade	1	2	3	4	5	6	7	8	9	10	L	LL
Zone 1	1425	1571	1705	1766	1873	2017	2072	2304	2448	2627	2875	3545
Zone 2	1446	1595	1731	1792	1901	2047	2103	2339	2485	2666	2918	3598
Zone 3	1468	1618	1756	1819	1929	2078	2134	2373	2521	2706	2961	3651

OPTION	PRICE	CODE
No Brass Trim Option	N/C	NB
Non-Tufted Option	N/C	NT

- Tufted seat and back
- Brass nail head trim on arms and seat
- Queen Anne style legs on front
- Seat: 19.5"F-16"B W x 18.25"D x 18.5"H
- SIN 711-18

QS NOW

4074 Wing Back Arm Chair

29" W X 31" D X 40.5" H

St. Yardage: 4.5



Freight Class: 250
 Cubic Ft: 26
 Ship Weight: 51

Grade	1	2	3	4	5	6	7	8	9	10	L	LL
Zone 1	1509	1620	1735	1911	2037	2193	2269	2541	2711	2920	3052	3809
Zone 2	1532	1644	1761	1940	2068	2226	2303	2579	2752	2964	3098	3866
Zone 3	1554	1669	1787	1968	2098	2259	2337	2617	2792	3008	3144	3923

OPTION	PRICE	CODE
No Brass Trim Option	N/C	NB
Non-Tufted Option	N/C	NT

- Full-size seat and back
- Queen Anne style legs on front
- Tufted seat and back
- Brass nail head trim on arms and seat
- Seat: 18"B-22.5"F W x 19"D x 18.5"H
- SIN 711-18

QS NOW

4075 Arm Chair

28" W X 26" D X 32" H

St. Yardage: 3.5

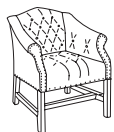

Freight Class: 250
 Cubic Ft: 14
 Ship Weight: 46

Grade	1	2	3	4	5	6	7	8	9	10	L	LL
Zone 1	1373	1498	1594	1647	1690	1734	1767	1909	1995	2105	2672	2918
Zone 2	1394	1520	1618	1672	1715	1760	1794	1938	2025	2137	2712	2962
Zone 3	1414	1543	1642	1696	1741	1786	1820	1966	2055	2168	2752	3006

OPTION	PRICE	CODE
No Brass Trim Option	N/C	NB
Non-Tufted Option	N/C	NT

- Tufted seat and back
- Brass nail head trim on arms and seat
- Chippendale style legs
- Cross rails for additional leg support
- Seat: 17"W x 18"D x 19.5"H
- SIN 711-18

QS NOW

TRADITIONAL

4083 Sofa

78" W X 28" D X 35" H

St. Yardage: 8

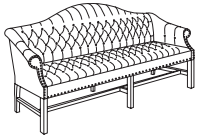

Grade	1	2	3	4	5	6	7	8	9	10	L	LL
Zone 1	2493	2778	3020	3156	3368	3451	3792	4005	4270	4772	5702	5966
Zone 2	2530	2820	3065	3203	3419	3503	3849	4065	4334	4844	5788	6055
Zone 3	2568	2861	3111	3251	3469	3555	3906	4125	4398	4915	5873	6145

Freight Class: 250
Cubic Ft: 56
Ship Weight: 113

- Tufted seat, back and inside arms
- Brass nail head trim on arms and seat
- Traditional scroll arm and camelback
- Chippendale style legs
- Cross rail adds leg support
- Seat: 66"W x 18"D x 19"H

CASTER	PRICE	CODE
No Brass Trim Option	N/C	NB
Non-Tufted Option	N/C	NT

SIN 711-16

QS NOW

TR_4020 Traditional Cocktail Table



Freight Class: 100

- High-gloss, high pressure laminate top in Mahogany and Windsor Cherry
- Shaped edges
- Ships unassembled, easy assembly

	Zone Pricing	1	2	3	
54" X 24" X 16"	Cubic Ft: 5.5	Ship Weight: 69.5	833	845	858

Finish Options: Mahogany (M), Windsor Cherry (WC)

SIN 711-11

QS

TR_4023 Traditional End Table

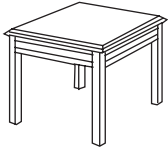

Freight Class: 92.5

- High-gloss, high pressure laminate top in Mahogany and Windsor Cherry
- Shaped edges
- Ships unassembled, easy assembly

22" X 27" X 18"	Cubic Ft: 2.5	Ship Weight: 38	689	699	710
-----------------	---------------	-----------------	-----	-----	-----

Finish Options: Mahogany (M), Windsor Cherry (WC)

SIN 711-11

QS

FINISH SELECTION

ASPEN AP | BLACK BLK | BOARDWALK BW | ESPRESSO ESP | HONEY CHERRY HCY | MAHOGANY MAH | MOAB MOB | ROUGE MAHOGANY RM | WINDSOR CHERRY WC | DRIFTWOOD DW | SHORELINE SL |

SIN 711-16 CHESTERFIELD

Traditional Comfort

Fully-upholstered Chesterfield, inspired by original designs features oversized scroll arms and extra-deep seat comfort.

Accents include tufting, individually-placed brass nail trim and bun-style feet.

Chesterfield Details

- High-density foam, no-sag sinuous spring suspensions
- Traditional tufting upholstery stitching is standard
- Brass nail trim
- Bun feet

Additional Options

- Non-Tufted option
- No Brass Trim option



TRADITIONAL

Chesterfield

4301 Club Chair

40" W X 36" D X 28" H

St. Yardage: 6.5

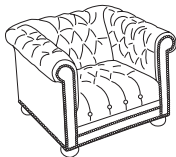

Freight Class: 250

Cubic Ft: 31

Ship Weight: 95

Grade	1	2	3	4	5	6	7	8	9	10	L	LL
Zone 1	2290	2513	2715	2837	3011	3193	3361	3533	3753	4053	4691	4838
Zone 2	2324	2551	2756	2880	3056	3241	3411	3586	3809	4114	4761	4911
Zone 3	2359	2588	2796	2922	3101	3289	3462	3639	3866	4175	4832	4983

- Extra-deep seat comfort
- Deep-well tufting
- Puzzle-joint construction, wood frame
- See features in series overview above
- Seat: 24.5"W x 23.5"D x 18"H

OPTION	PRICE	CODE
No Brass Trim	N/C	NB
Non-TuftedOption	N/C	NT

QS NOW

4302 Loveseat

61" W X 36" D X 28" H

St. Yardage: 9

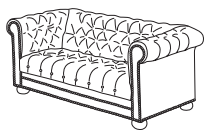

Freight Class: 250

Cubic Ft: 57

Ship Weight: 144

Grade	1	2	3	4	5	6	7	8	9	10	L	LL
Zone 1	3064	3370	3643	3804	4042	4133	4401	4752	5049	5339	5727	6517
Zone 2	3110	3421	3698	3861	4103	4195	4467	4823	5125	5419	5813	6615
Zone 3	3156	3471	3752	3918	4163	4257	4533	4895	5200	5499	5899	6713

- Extra-deep seat comfort
- Deep-well tufting
- Puzzle-joint construction, wood frame
- See features in series overview above
- Seat: 44.5"W x 23.5"D x 18"H

OPTION	PRICE	CODE
No Brass Trim	N/C	NB
Non-TuftedOption	N/C	NT

QS NOW

4303 Sofa

78" W X 36" D X 28" H

St. Yardage: 11



Freight Class: 250

Cubic Ft: 71

Ship Weight: 180

Grade	1	2	3	4	5	6	7	8	9	10	L	LL
Zone 1	3824	4207	4549	4740	5035	5147	5621	6144	6975	7592	8080	8625
Zone 2	3881	4270	4617	4811	5111	5224	5705	6236	7080	7706	8201	8754
Zone 3	3939	4333	4685	4882	5186	5301	5790	6328	7184	7820	8322	8884

- Extra-deep seat comfort
- Deep-well tufting
- Puzzle-joint construction, wood frame
- See features in series overview above
- Seat: 64"W x 23.5"D x 18"H

OPTION	PRICE	CODE
No Brass Trim	N/C	NB
Non-TuftedOption	N/C	NT

QS NOW

SEATING OFFICE



Stay Up-to-Date with Nexstep

The **Nexstep** collection of seating features the latest in seating materials and contemporary office styles. Featuring Air Grid mesh back material and breathable fabrics to help you keep your cool, Nexstep seating includes executive, management, guest and a stacking arm chair.

Nexstep Details

- 751s- *Leather Executive chairs with metal base in gunmetal finish. Air Grid mesh back. Optional headrest*
- 752s- *Management chairs with Air Grid mesh fabric back and black frame.*
- 759s- *Guest chairs with thickly padded contour seat and Air Grid mesh back.*

Additional Features & Options

- *Optional fabric of your choice on seat*
- *Optional fabric of your choice on headrest—751 models only*
- *Upgrade to a dual density seat cushion for extra comfort*
- *Tilt-tension adjustment on swivel chairs*
- *Pneumatic seat-height adjustment on swivel chairs*
- *Ergonomically-shaped armrests*



751 Executive & 752 Management

Nexstep

Zone Pricing	1	2	3
--------------	---	---	---

751 Leather Executive Chair



Freight Class: 125

- Mesh back
- Adjustable lumbar support
- Black leather seat and back trim
- 2-to-1 synchro tilt
- Pneumatic lift
- Height adjustable arms
- Black with gunmetal steel base
- Weight capacity 300 lbs.
- Easy to assemble
- Can ship via FedEx Ground
- Maximum quantity for Quick Ship is 50
- Seat: 21"W x 20"D x 18.5-23"H

28" X 27.5" X 40-44" Cubic Ft: 6 Ship Weight: 57			1029	1044	1060
OPTION	PRICE	CODE			
Assembly	48.00	A			
CASTER	PRICE	CODE			
Self-Locking Casters	85.00	S			
Braking Casters	30.00	B			
Hard-Floor Casters	19.00	H			
Glides	N/C	GL			
Assembled Specs: Ship Wt: 57 Cubes: 21					

QS NOW

752 Management Chair, Fabric Seat



Freight Class: 125

- Mesh back with passive lumbar support
- 2-to-1 synchro tilt
- Pneumatic lift
- Height adjustable arms
- Black Poly Base
- Weight capacity 300 lbs.
- Easy to assemble
- Can ship via FedEx Ground
- Maximum quantity for Quick Ship is 50
- Seat: 20"W x 20"D x 18.5-22.5"H

26.5" X 26 5" X 38-42" Cubic Ft: 6 Ship Weight: 40			714	725	735
OPTION	PRICE	CODE			
Assembly	48.00	A			
CASTER	PRICE	CODE			
Self-Locking Casters	85.00	S			
Braking Casters	30.00	B			
Hard-Floor Casters	19.00	H			
Glides	N/C	GL			
Assembled Specs: Ship Wt: 49 Cubes: 22					

QS NOW

759 Guest Chair



Freight Class: 100

- Mesh back with built in lumbar support
- Breathable black fabric seat
- Fixed angled T-arms
- Black heavy duty tubular steel sled base
- Easy to assemble
- Can ship via FedEx Ground
- Maximum quantity for Quick Ship is 50
- Seat: 20"W x 20"D x 19.5"H

QS NOW

Zone Pricing	1	2	3
26.5" X 26.5" X 37.25" Cubic Ft: 6 Ship Weight: 38	544	552	560

OPTION	PRICE	CODE
Assembly	48.00	A

HR751 Black Headrest Only for 751 Chair

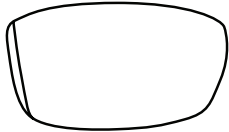

Freight Class: 70

- Black mesh fabric
- Easy to attach
- Adjustable height
- Fits 751 chairs only
- Can ship via FedEx Ground

15.5" X 4" X 9" Cubic Ft: 1 Ship Weight: 1.72	171	174	176
---	------------	------------	------------

757B Nesting Chair

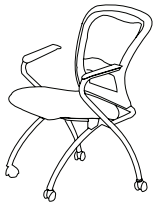

Freight Class: 250

- Black breathable ProGrid back
- Built-in lumbar support
- Black fabric padded seat
- Black finish on steel frame
- Dual wheel carpet casters
- Seat folds up for horizontal nesting
- Seat: 18"W x 19"D x 19.25"H

24" X 24 5" X 36.5" Cubic Ft: 12 Ship Weight: 33	469	476	483
--	------------	------------	------------

751G Executive Chair



Freight Class: 250
Cubic Ft: 22
Ship Weight: 58

28" W X 27.5" D X 40-44" H St. Yardage: 1

Grade	1	2	3	4	5	6	7	8	9	10	L	LL
Zone 1	1193	1214	1229	1253	1272	1297	1306	1346	1371	1402		
Zone 2	1211	1232	1247	1272	1291	1316	1326	1366	1392	1423		
Zone 3	1229	1250	1266	1291	1310	1336	1345	1386	1412	1444		

CASTER	PRICE	CODE
Self-Locking Casters	85.00	S
Braking Casters	30.00	B
Hard-Floor Casters	19.00	H
Glides	N/C	GL

QS NOW

751GHR Executive Chair, Fabric Seat & Headrest



Freight Class: 250
Cubic Ft: 26
Ship Weight: 72

28" W X 27.5" D X 49-53" H St. Yardage: 1

Grade	1	2	3	4	5	6	7	8	9	10	L	LL
Zone 1	1306	1324	1342	1360	1377	1400	1421	1445	1468	1497		
Zone 2	1326	1344	1362	1380	1398	1421	1442	1467	1490	1519		
Zone 3	1345	1364	1382	1401	1418	1442	1464	1488	1512	1542		

CASTER	PRICE	CODE
Self-Locking Casters	85.00	S
Braking Casters	30.00	B
Hard-Floor Casters	19.00	H
Glides	N/C	GL

QS NOW

752G Management Chair

26.5" W X 26.5" D X 38-42" H

St. Yardage: 1



Freight Class: 250
Cubic Ft: 22
Ship Weight: 49

Grade	1	2	3	4	5	6	7	8	9	10	L	LL
Zone 1	803	820	840	863	882	908	916	955	981	1011		
Zone 2	815	832	853	876	895	922	930	969	996	1026		
Zone 3	827	845	865	889	908	935	943	984	1010	1041		

- Mesh back with passive lumbar support
- 2-to-1 Synchro Tilt
- Height adjustable arms
- Black poly base
- Weight capacity 300 lbs
- Choose any HPFI fabric for seat
- Extra thick dual density foam
- Ships fully assembled truck only
- Seat: 20"W x 20"D x 18.5-22.5"H

CASTER	PRICE	CODE
Self-Locking Casters	85.00	S
Braking Casters	30.00	B
Hard-Floor Casters	19.00	H
Glides	N/C	GL

QS NOW

759G Guest Chair, Fabric Seat

26.5" W X 26.5" D X 37.25" H

St. Yardage: 1



Freight Class: 250
Cubic Ft: 15
Ship Weight: 40

Grade	1	2	3	4	5	6	7	8	9	10	L	LL
Zone 1	584	605	620	644	662	687	697	736	762	793		
Zone 2	593	614	629	654	672	697	707	747	773	805		
Zone 3	602	623	639	663	682	708	718	758	785	817		

- Mesh back with passive lumbar support
- Choose any HPFI fabric for seat
- Fixed angled T-arms
- Black heavy duty tubular steel sled base
- Extra thick dual density foam
- Chair with optional upholstery ships fully assembled
- Maximum quantity for Quick Ship is 50
- Seat: 20"W x 20"D x 19.5"H
- Ships fully assembled truck only

QS NOW

HR751G Fabric Headrest for 751 Chair

15.5" W X 4" D X 9" H

St. Yardage: .25

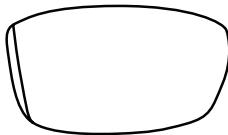

Freight Class: 70
Cubic Ft: 1
Ship Weight: 4

Grade	1	2	3	4	5	6	7	8	9	10	L	LL
Zone 1	200	204	210	215	219	225	228	238	244	253		
Zone 2	203	207	213	218	222	228	231	242	248	257		
Zone 3	206	210	216	221	226	232	235	245	251	261		

- Choose any HPFI fabric for seat
- Easy to attach
- Fits 751 chairs only
- Adjustable height
- Can ship via FedEx Ground

QS NOW

757 Nesting Chair

24" W X 24.5" D X 36.5" H

St. Yardage: 1



Freight Class: 250
Cubic Ft: 12
Ship Weight: 33

Grade	1	2	3	4	5	6	7	8	9	10	L	LL
Zone 1	528	545	562	582	600	621	644	667	690	718	760	881
Zone 2	536	553	570	591	609	630	654	677	700	729	771	894
Zone 3	544	561	579	599	618	640	663	687	711	740	783	907

- Black breathable ProGrid back
- Built-in lumbar support
- Choose any fabric for seat
- Black finish on steel frame
- Black urethane arms
- Dual wheel carpet casters
- Seat folds up for horizontal nesting
- Seat: 18"W x 19"D x 19.25"H
- Ships fully assembled

QS NOW

Go Fast with Fast Cats: Cougar

Elegant arched back sets **Cougar** apart from the pack. Cougar is available in executive and management models. Multifunction mechanism control adjusts position of chair components for active users.

Cougar Features

- Adjustable seat height, 4" range-Pneumatic
- Adjustable back height, 4" range — 6 positions
- Adjustable arm height, 3" range — 6 positions
- Seats slider adjusts seat depth to 2"
- Adjustable arm width, 4" range — 2" per arm
- Swivel/tilt with tilt lock
- Back angle adjustment
- Forward seat tilt and tilt lock

Back Height Choices

- Executive 24.5" high back
- Management 22" high back

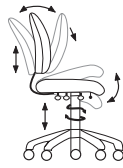

Cougar Mechanism

Multifunction Control adjusts position of chair components for active users.

- Swivel, tilt and tilt lock
- Tilt tension adjustment
- Back angle adjustment
- Forward seat tilt adjustment with forward tilt lock



Specifications

Overall

- Width 27"-31", Depth 25"-27"
- Height 37"-41" (Mgmt)
- Height 39"-43" (Exec)

Seat

- Width 20.75", Depth 20.25"
- Thickness 4"

Back

- Width 20" (Exec) 19" (Mgmt)
- Height 24-1/2" (Exec) 22" (Mgmt)
- Thickness 4"

Other

- Seat Height 19"-23"
- Arm Height from seat 7"-10"

Cougar

621 Executive Swivel Chair

27" W X 25.5" D X 39-43" H

St. Yardage: 2.75



Freight Class: 250

Cubic Ft: 23

Ship Weight: 66

Grade	1	2	3	4	5	6	7	8	9	10	L	LL
Zone 1	950	985	1023	1094	1139	1197	1259	1318	1380	1453	1597	1707
Zone 2	964	1000	1038	1110	1156	1215	1278	1338	1401	1475	1621	1733
Zone 3	979	1015	1054	1127	1173	1233	1297	1358	1421	1497	1645	1758

- Multifunction mechanism
- Executive height back
- Standard seat slider travels 2"
- Ships fully assembled
- Nylon base with metal understructure
- Seat: 20.75"W x 20.25"D x 19-23"H

OPTION	PRICE	CODE
Upholstered Back	59.00	UB
CASTER	PRICE	CODE
Self-Locking Casters	85.00	S
Braking Casters	30.00	B
Hard-Floor Casters	19.00	H
Glides	N/C	GL

QS NOW

627 Management Swivel Chair

27" W X 25.5" D X 37-41" H

St. Yardage: 2.5

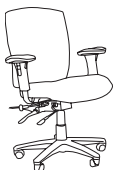

Freight Class: 250

Cubic Ft: 21

Ship Weight: 64

Grade	1	2	3	4	5	6	7	8	9	10	L	LL
Zone 1	883	919	954	1027	1070	1131	1191	1251	1311	1386	1530	1639
Zone 2	896	933	968	1042	1086	1148	1209	1270	1331	1407	1553	1664
Zone 3	909	947	983	1058	1102	1165	1227	1289	1350	1428	1576	1688

- Multifunction mechanism
- Management height back
- Standard seat slider travels 2"
- Ships fully assembled
- Nylon base with metal understructure
- Seat: 20.75"W x 20.25"D x 19-23"H

OPTION	PRICE	CODE
Upholstered Back	59.00	UB
CASTER	PRICE	CODE
Self-Locking Casters	85.00	S
Braking Casters	30.00	B
Hard-Floor Casters	19.00	H
Glides	N/C	GL

QS NOW

Go Fast with Fast Cats: Puma

Elegant arched back sets **Puma** apart from the pack. Puma is available in executive and management models. Syncrotilt mechanism and adjustable components for active users.

Puma Features

- Adjustable seat height, 4" range-Pneumatic
- Adjustable back height, 4" range — 6 positions
- Adjustable arm height, 3" range — 6 positions
- Adjustable arm width, 4" range — 2" per arm



Back Height Choices

- Executive 24.5" high back
- Management 22" high back

Syncrotilt Mechanism

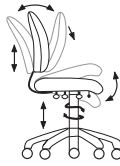

- Swivel, tilt and tilt lock
- 360° Swivel Pneumatic lift
- 2:1 ratio back-to-seat angle adjustment as you recline

Specifications

Overall

- Width 27"-31", Depth 25"-27"
- Height 37"-41" (Mgmt)
- Height 39"-43" (Exec)

Seat

- Width 20.75", Depth 20.25"
- Thickness 4"

Back

- Width 20" (Exec) 19" (Mgmt)
- Height 24-1/2" (Exec) 22" (Mgmt)
- Thickness 4"

Other

- Seat Height 19"-23"
- Arm Height from seat 7"-10"

Puma

631 Executive Swivel Chair, Synchro Tilt

27" W X 25.5" D X 39-43" H

St. Yardage: 2.75



Freight Class: 250
Cubic Ft: 23
Ship Weight: 66

Grade	1	2	3	4	5	6	7	8	9	10	L	LL
Zone 1	835	869	907	930	976	1021	1080	1139	1197	1256	1326	1541
Zone 2	848	882	921	944	991	1036	1096	1156	1215	1275	1346	1564
Zone 3	860	895	934	958	1005	1052	1112	1173	1233	1294	1366	1587

- Synchro tilt mechanism
- 2:1 ratio back-to-seat angle adjustment as you recline
- Pneumatic seat height adjustment
- Swivel/tilt with tilt lock
- Adjustable back height
- Height and width adjustable T-arms
- Black nylon base with metal understructure
- Ships fully assembled
- Seat: 20.75"W x 20.25"D x 19-23"H

OPTION	PRICE	CODE
Upholstered Back	59.00	UB
CASTER	PRICE	CODE
Self-Locking Casters	85.00	S
Braking Casters	30.00	B
Hard-Floor Casters	19.00	H
Glides	N/C	GL

QS NOW

637 Management Swivel, Synchro Tilt

27" W X 25.5" D X 37-41" H

St. Yardage: 2.5



Freight Class: 250
Cubic Ft: 21
Ship Weight: 64

Grade	1	2	3	4	5	6	7	8	9	10	L	LL
Zone 1	769	804	839	865	910	953	1012	1071	1132	1190	1259	1471
Zone 2	781	816	852	878	924	967	1027	1087	1149	1208	1278	1493
Zone 3	792	828	864	891	937	982	1042	1103	1166	1226	1297	1515

- Synchro tilt mechanism
- 2:1 ratio back-to-seat angle adjustment as you recline
- Pneumatic seat height adjustment
- Swivel/tilt with tilt lock
- Adjustable back height
- Height and width adjustable T-arms
- Black nylon base with metal understructure
- Ships fully assembled
- Seat: 20.75"W x 20.25"D x 19-23"H

OPTION	PRICE	CODE
Upholstered Back	59.00	UB
CASTER	PRICE	CODE
Self-Locking Casters	85.00	S
Braking Casters	30.00	B
Hard-Floor Casters	19.00	H
Glides	N/C	GL

QS NOW

Go Fast with Fast Cats: Cheetah

In a fast-paced work environment, **Cheetah** will keep you moving.

Cheetah Features

- Adjustable seat height, 5" range-Pneumatic
- Adjustable back height, 2" range-Manual
- Adjustable back depth, 2" range
- Free float back angle adjustment
- 360° Swivel
- Resin back & seat pan
- Contoured, molded foam
- Extra-wide seats & bases

Specifications

Overall

- Width 24" (with arms), Depth 24" Height 32"-37"

Seat

- Width 20", Depth 18", Thickness 2.5"

Back

- Width 17", Depth 16.5", Thickness 2.5"

Other

- Seat Height 18"-23"
- Arm Height from seat 6.5"
- Arm Height from floor 23.5"
(Measured with seat/arms in lowest position)

Arm Choices

Adjustable T Arms (AT)

- 2.5" height adjustments (5 positions)
- 2" wide adjustment (1" per arm)



Armless Task Chair 500

Cheetah Standard Height

50050AT Task Chair

24" W X 24" D X 32-37" H

St. Yardage: 1



Freight Class: 150
Cubic Ft: 11
Ship Weight: 44

Grade	1	2	3	4	5	6	7	8	9	10	L	LL
Zone 1	557	618	673	713	762	781	862	913	974	1093	1141	1259
Zone 2	565	627	683	724	773	793	875	927	989	1109	1158	1278
Zone 3	574	637	693	734	785	804	888	940	1003	1126	1175	1297

- 17" high back
- 360° swivel
- Adjustable T-arms
- Can ship via ground service
- Requires assembly
- Seat: 20"W x 18"D x 18-23"H

OPTION	PRICE	CODE
Assembly	48.00	A
CASTER	PRICE	CODE
Self-Locking Casters	85.00	S
Braking Casters	30.00	B
Hard-Floor Casters	19.00	H
Glides	N/C	GL

QS NOW

500 Armless Task Chair

20" W X 24" D X 32-37" H

St. Yardage: 1



Freight Class: 150
Cubic Ft: 11
Ship Weight: 36

Grade	1	2	3	4	5	6	7	8	9	10	L	LL
Zone 1	437	493	552	567	605	643	662	742	793	855	1036	1196
Zone 2	444	500	560	576	614	653	672	753	805	868	1052	1214
Zone 3	450	508	569	584	623	662	682	764	817	881	1067	1232

- 17" high back
- 360° swivel
- Armless
- Can ship via ground service
- Requires assembly
- Seat: 20"W x 18"D x 18-23"H

OPTION	PRICE	CODE
Assembly	48.00	A
CASTER	PRICE	CODE
Self-Locking Casters	85.00	S
Braking Casters	30.00	B
Hard-Floor Casters	19.00	H
Glides	N/C	GL

QS NOW

Cheetah Extended Height

59050AT Extended-Height Task Chair

24" W X 24" D X 40-50" H

St. Yardage: 1



Freight Class: 150

Cubic Ft: 12

Ship Weight: 49

Grade	1	2	3	4	5	6	7	8	9	10	L	LL
Zone 1	782	847	904	940	987	1007	1088	1139	1200	1318	1371	1599
Zone 2	794	860	918	954	1002	1022	1104	1156	1218	1338	1392	1623
Zone 3	805	872	931	968	1017	1037	1121	1173	1236	1358	1412	1647

- 360° swivel
- 10" vertical seat height adjustment (pneumatic)
- 18" diameter foot ring
- 2.5" height-adjustable arms
- 10" vertical foot ring height adjustment (manual)
- 2" arm width adjustment
- Requires assembly
- Seat: 20"W x 18"D x 26-30"H

OPTION	PRICE	CODE
Assembly	48.00	A
CASTER	PRICE	CODE
Self-Locking Casters	85.00	S
Braking Casters	30.00	B
Hard-Floor Casters	19.00	H
Glides	N/C	GL

Seat Height (From Floor) 24-34" Arm Height (From Seat) 6.5-9"
 Foot Ring Height (From Floor) 8-18" Back Size 17.5"W x 16.5"D

QS **NOW**

590 Extended-Height Armless Task Chair

20" W X 24" D X 40-50" H

St. Yardage: 1

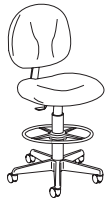

Freight Class: 150

Cubic Ft: 11

Ship Weight: 40

Grade	1	2	3	4	5	6	7	8	9	10	L	LL
Zone 1	638	701	761	793	842	862	943	993	1055	1173	1226	1453
Zone 2	648	712	772	805	855	875	957	1008	1071	1191	1244	1475
Zone 3	657	722	784	817	867	888	971	1023	1087	1208	1263	1497

- 360° swivel
- 10" vertical seat height adjustment (pneumatic)
- 18" diameter foot ring
- Armless
- 10" vertical foot ring height adjustment (manual)
- Requires assembly
- Seat: 20"W x 18"D x 26-30"H

OPTION	PRICE	CODE
Assembly	48.00	A
CASTER	PRICE	CODE
Self-Locking Casters	85.00	S
Braking Casters	30.00	B
Hard-Floor Casters	19.00	H
Glides	N/C	GL

Seat Height (From Floor) 24-34" Foot Ring Height (From Floor) 8-18"
 Back Size 17.5"W x 16.5"D

QS **NOW**

Oversized Comfort

Leaders chairs are designed and built for executive level style and comfort. With careful attention to detail, they are scaled for the executive office. Impressive in every environment.

Design Details

- *Traditional*— Period influenced styling with gooseneck, wingback and other classical styles
- *Transitional*— Large-scaled seating designed with comfort in mind. Recommended for larger, longer body types
- *Contemporary*— Square-pattern stitching is paired with oversize seat & back for unique and comfortable styling

Additional Options

- *Optional Knee Tilt*



Executive 121



Executive 141



Executive 161



Executive 101

Leaders Executive

101 Executive Swivel, Spider Base

27.5" W X 29" D X 43.5-46.5" H St. Yardage: 4



Freight Class: 250
 Cubic Ft: 26
 Ship Weight: 68

Grade	1	2	3	4	5	6	7	8	9	10	L	LL
Zone 1	2016	2149	2279	2294	2367	2480	2522	2703	2816	2956	3365	3854
Zone 2	2046	2181	2313	2328	2403	2517	2560	2744	2858	3000	3415	3912
Zone 3	2076	2213	2347	2363	2438	2554	2598	2784	2900	3045	3466	3970

- Generous seat width/depth
- Dual-composition cushioning
- Fully upholstered
- Pneumatic lift
- Tilt tension adjustment
- Black, nylon reinforced spider base
- Black dual-wheel carpet casters
- Seat: 21"W x 19"D x 20-23"H

OPTION	PRICE	CODE
Knee Tilt Control	100.00	K
CASTER	PRICE	CODE
Self-Locking Casters	85.00	S
Braking Casters	30.00	B
Hard-Floor Casters	19.00	H
Glides	N/C	GL

QS NOW

101_ Executive Swivel, Wood Base

27.5" W X 29" D X 43.5-46.5" H St. Yardage: 4



Freight Class: 250
 Cubic Ft: 26
 Ship Weight: 68

Grade	1	2	3	4	5	6	7	8	9	10	L	LL
Zone 1	2151	2284	2416	2429	2503	2614	2657	2839	2951	3092	3500	3989
Zone 2	2183	2318	2452	2465	2541	2653	2697	2882	2995	3138	3553	4049
Zone 3	2216	2353	2488	2502	2578	2692	2737	2924	3040	3185	3605	4109

- Same description as above except:
- Two-tone, low-profile base with black die-cast aluminum structure
- Wood caps; specify finish designator
- Seat: 21"W x 19"D x 20-23"H

OPTION	PRICE	CODE
Knee Tilt Control	100.00	K
CASTER	PRICE	CODE
Self-Locking Casters	85.00	S
Braking Casters	30.00	B
Hard-Floor Casters	19.00	H
Glides	N/C	GL

QS NOW

FINISH SELECTION

NATURAL MAPLE **FM** | ASPEN **AP** | WINDSOR CHERRY **WC** | MAHOGANY **MAH** |
 ESPRESSO **ESP** | HONEY CHERRY **HCY** | ROUGE MAHOGANY **RM** | BLACK **BLK** |
 BOARDWALK **BW** | MOAB **MOB** | SHORELINE **SL** | DRIFTWOOD **DW** |

121 Executive Swivel, Spider Base

27" W X 32" D X 43-47" H St. Yardage: 5



Freight Class: 250
 Cubic Ft: 26
 Ship Weight: 73

Grade	1	2	3	4	5	6	7	8	9	10	L	LL
Zone 1	2174	2328	2482	2496	2583	2714	2763	2976	3107	3271	3742	4318
Zone 2	2207	2363	2519	2533	2622	2755	2804	3021	3154	3320	3798	4383
Zone 3	2239	2398	2556	2571	2660	2795	2846	3065	3200	3369	3854	4448

- Generous seat width/depth
- Dual-composition cushioning
- Fully upholstered
- Pneumatic lift
- Tilt tension adjustment
- Black, nylon reinforced spider base
- Black dual-wheel carpet casters
- Seat: 20"W x 20"D x 21-25"H

OPTION	PRICE	CODE
Knee Tilt Control	100.00	K
Softer Seat Foam-Chair	16.00	SF
Edge Guard	16.00	E
CASTER	PRICE	CODE
Self-Locking Casters	85.00	S
Braking Casters	30.00	B
Hard-Floor Casters	19.00	H
Glides	N/C	GL

QS NOW

121 Executive Swivel, Wood Base

27" W X 32" D X 43-47" H St. Yardage: 5



Freight Class: 250
 Cubic Ft: 26
 Ship Weight: 73

Grade	1	2	3	4	5	6	7	8	9	10	L	LL
Zone 1	2307	2460	2619	2638	2718	2847	2899	3110	3241	3404	3875	4452
Zone 2	2342	2497	2658	2678	2759	2890	2942	3157	3290	3455	3933	4519
Zone 3	2376	2534	2698	2717	2800	2932	2986	3203	3338	3506	3991	4586

- Same description as above except:
- Two-tone, low-profile base with black die-cast aluminum structure
- Wood caps; specify finish designator

OPTION	PRICE	CODE
Knee Tilt Control	100.00	K
Softer Seat Foam-Chair	16.00	SF
Edge Guard	16.00	E
CASTER	PRICE	CODE
Self-Locking Casters	85.00	S
Braking Casters	30.00	B
Hard-Floor Casters	19.00	H
Glides	N/C	GL

QS NOW

191 Executive Swivel, Spider Base

30.25" W X 31.5" D X 42.5-45.5" H St. Yardage: 6



Freight Class: 250
 Cubic Ft: 26
 Ship Weight: 73

Grade	1	2	3	4	5	6	7	8	9	10	L	LL
Zone 1	1562	1765	1927	1941	2030	2179	2236	2479	2628	2815	3779	4013
Zone 2	1585	1791	1956	1970	2060	2212	2270	2516	2667	2857	3836	4073
Zone 3	1609	1818	1985	1999	2091	2244	2303	2553	2707	2899	3892	4133

- Welt cord trim
- Dual-composition cushioning
- Fully upholstered
- Pneumatic lift
- Tilt tension adjustment
- Black, nylon reinforced spider base
- Black dual-wheel carpet casters
- Seat: 18.5"W x 19"D x 17.5-20.5"H

OPTION	PRICE	CODE
Knee Tilt Control	100.00	K
Softer Seat Foam-Chair	16.00	SF
Edge Guard	16.00	E
CASTER	PRICE	CODE
Self-Locking Casters	85.00	S
Braking Casters	30.00	B
Hard-Floor Casters	19.00	H
Glides	N/C	GL

QS NOW

FINISH SELECTION

NATURAL MAPLE **FM** | ASPEN **AP** | WINDSOR CHERRY **WC** | MAHOGANY **MAH** |
 MOAB **MOB** | ESPRESSO **ESP** | HONEY CHERRY **HCY** | ROUGE MAHOGANY **RM** |
 BLACK **BLK** | BOARDWALK **BW** | SHORELINE **SL** | DRIFTWOOD **DW** |

LEADERS

191_ Executive Swivel, Wood Base

30.25" W X 31.5" D X 42.5-45.5" H St. Yardage: 6



Freight Class: 250
 Cubic Ft: 26
 Ship Weight: 77

Grade	1	2	3	4	5	6	7	8	9	10	L	LL
Zone 1	1705	1909	2070	2082	2172	2322	2378	2622	2769	2957	3922	4156
Zone 2	1731	1938	2101	2113	2205	2357	2414	2661	2811	3001	3981	4218
Zone 3	1756	1966	2132	2144	2237	2392	2449	2701	2852	3046	4040	4281

- Same description as above except:
- Two-tone, low-profile base with black die-cast aluminum structure
- Wood caps; specify finish designator
- Seat: 18.5"W x 19"D x 17.5-20.5"H

OPTION	PRICE	CODE
Knee Tilt Control	100.00	K
Softer Seat Foam-Chair	16.00	SF
Edge Guard	16.00	E
CASTER	PRICE	CODE
Self-Locking Casters	85.00	S
Braking Casters	30.00	B
Hard-Floor Casters	19.00	H
Glides	N/C	GL

QS NOW

141 Executive Swivel, Spider Base

26.5" W X 31" D X 41.5-45" H St. Yardage: 3.5



Freight Class: 250
 Cubic Ft: 21
 Ship Weight: 61

Grade	1	2	3	4	5	6	7	8	9	10	L	LL
Zone 1	1812	1985	2145	2165	2221	2277	2319	2501	2612	2753	3650	3792
Zone 2	1839	2015	2177	2197	2254	2311	2354	2539	2651	2794	3705	3849
Zone 3	1866	2045	2209	2230	2288	2345	2389	2576	2690	2836	3760	3906

- Generous seat width/depth
- Dual-composition cushioning
- Square pattern stitching with hand pulled reliefs
- For other Himalaya options, see page 202
- Fully upholstered
- Pneumatic lift
- Tilt tension adjustment
- Black, nylon reinforced spider base
- Black dual-wheel carpet casters
- Seat: 20.5"W x 20.5"D x 18-22"H

OPTION	PRICE	CODE
Knee Tilt Control	100.00	K
Softer Seat Foam-Chair	16.00	SF
Edge Guard	16.00	E
CASTER	PRICE	CODE
Self-Locking Casters	85.00	S
Braking Casters	30.00	B
Hard-Floor Casters	19.00	H
Glides	N/C	GL

QS NOW

141_ Executive Swivel, Wood Base

26.5" W X 31" D X 41.5-45" H St. Yardage: 3.5



Freight Class: 250
 Cubic Ft: 21
 Ship Weight: 61

Grade	1	2	3	4	5	6	7	8	9	10	L	LL
Zone 1	1947	2120	2278	2297	2411	2452	2634	2747	2886	3153	3785	3927
Zone 2	1976	2152	2312	2331	2447	2489	2674	2788	2929	3200	3842	3986
Zone 3	2005	2184	2346	2366	2483	2526	2713	2829	2973	3248	3899	4045

- Same description as above except:
- Two-tone, low-profile base with black die-cast aluminum structure
- Wood caps; specify finish designator
- Seat: 20.5"W x 20.5"D x 17.5-21.5"H

OPTION	PRICE	CODE
Knee Tilt Control	100.00	K
Softer Seat Foam-Chair	16.00	SF
Edge Guard	16.00	E
CASTER	PRICE	CODE
Self-Locking Casters	85.00	S
Hard-Floor Casters	19.00	H
Glides	N/C	GL

QS NOW

143 Arm Chair

22.75" W X 26" D X 33.5" H St. Yardage: 1.75



Freight Class: 300
 Cubic Ft: 15
 Ship Weight: 27

Grade	1	2	3	4	5	6	7	8	9	10	L	LL
Zone 1	1092	1180	1256	1287	1348	1372	1474	1535	1614	1762	2041	2112
Zone 2	1108	1198	1275	1306	1368	1393	1496	1558	1638	1788	2072	2144
Zone 3	1125	1215	1294	1326	1388	1413	1518	1581	1662	1815	2102	2175

- Exposed legs and arms are solid hardwood
- Specify wood finish
- Square pattern stitching with hand pulled reliefs
- For other Himalaya options, see page 202
- Seat: 19"W x 18"D x 19"H

OPTION	PRICE	CODE
Softer Seat Foam-Chair	16.00	SF

QS NOW

FINISH SELECTION

NATURAL MAPLE **FM** | ASPEN **AP** | WINDSOR CHERRY **WC** | MAHOGANY **MAH** |
 ESPRESSO **ESP** | HONEY CHERRY **HCY** | ROUGE MAHOGANY **RM** | BLACK **BLK** |
 BOARDWALK **BW** | MOAB **MOB** | SHORELINE **SL** | DRIFTWOOD **DW** |

144 Armless Side Chair

19.5" W X 26" D X 33.5" H

St. Yardage: 1.75



Freight Class: 300
 Cubic Ft: 15
 Ship Weight: 25

Grade	1	2	3	4	5	6	7	8	9	10	L	LL
Zone 1	1049	1096	1211	1246	1307	1332	1431	1495	1571	1720	1976	2071
Zone 2	1065	1112	1229	1265	1327	1352	1452	1517	1595	1746	2006	2102
Zone 3	1080	1129	1247	1283	1346	1372	1474	1540	1618	1772	2035	2133

- Exposed legs are solid hardwood
- Specify wood finish
- Square pattern stitching with hand pulled reliefs
- For other Himalaya options, see page 202
- Seat: 19"W x 18"D x 19"H

OPTION	PRICE	CODE
Softer Seat Foam-Chair	16.00	SF

QS NOW

161 Executive Swivel, Spider Base

27.25" W X 32" D X 42-45" H

St. Yardage: 3.5



Freight Class: 250
 Cubic Ft: 26
 Ship Weight: 63

Grade	1	2	3	4	5	6	7	8	9	10	L	LL
Zone 1	1812	1985	2145	2168	2225	2263	2344	2424	2524	2649	3448	3792
Zone 2	1839	2015	2177	2201	2258	2297	2379	2460	2562	2689	3500	3849
Zone 3	1866	2045	2209	2233	2292	2331	2414	2497	2600	2728	3551	3906

- Generous seat width/depth
- Dual-composition cushioning
- Fully upholstered
- Pneumatic lift
- Tilt tension adjustment
- Black, nylon reinforced spider base
- Black dual-wheel carpet casters
- Seat: 20.5"W x 20.5"D x 19-22"H

OPTION	PRICE	CODE
Knee Tilt Control	100.00	K
Softer Seat Foam-Chair	16.00	SF
Edge Guard	16.00	E

CASTER	PRICE	CODE
Self-Locking Casters	85.00	S
Braking Casters	30.00	B
Hard-Floor Casters	19.00	H
Glides	N/C	GL

QS NOW

161 Executive Swivel, Wood Base

27.25" W X 32" D X 42-45" H

St. Yardage: 3.5

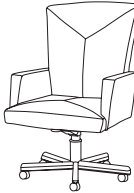

Freight Class: 250
 Cubic Ft: 26
 Ship Weight: 63

Grade	1	2	3	4	5	6	7	8	9	10	L	LL
Zone 1	1947	2120	2278	2359	2396	2478	2559	2657	2782	3019	3581	3927
Zone 2	1976	2152	2312	2394	2432	2515	2597	2697	2824	3064	3635	3986
Zone 3	2005	2184	2346	2430	2468	2552	2636	2737	2865	3110	3688	4045

- Same description as above except:
- Two-tone, low-profile base with black die-cast aluminum structure
- Wood caps; specify finish designator

OPTION	PRICE	CODE
Knee Tilt Control	100.00	K
Softer Seat Foam-Chair	16.00	SF
Edge Guard	16.00	E

CASTER	PRICE	CODE
Self-Locking Casters	85.00	S
Hard-Floor Casters	19.00	H
Glides	N/C	GL

QS NOW

163 Arm Chair

22.75" W X 26" D X 33.5" H

St. Yardage: 1.75



Freight Class: 300
 Cubic Ft: 15
 Ship Weight: 27

Grade	1	2	3	4	5	6	7	8	9	10	L	LL
Zone 1	1098	1180	1262	1293	1355	1380	1480	1541	1620	1768	2041	2119
Zone 2	1114	1198	1281	1312	1375	1401	1502	1564	1644	1795	2072	2151
Zone 3	1131	1215	1300	1332	1396	1421	1524	1587	1669	1821	2102	2183

- Exposed legs and arms are solid hardwood
- Specify wood finish
- Seat: 19"W x 17"D x 19"H

OPTION	PRICE	CODE
Softer Seat Foam-Chair	16.00	SF

QS NOW

164 Armless Side Chair

19.5" W X 26" D X 33.5" H

St. Yardage: 1.75



Freight Class: 300
 Cubic Ft: 15
 Ship Weight: 25

Grade	1	2	3	4	5	6	7	8	9	10	L	LL
Zone 1	1049	1096	1211	1246	1307	1332	1431	1495	1571	1720	1976	2071
Zone 2	1065	1112	1229	1265	1327	1352	1452	1517	1595	1746	2006	2102
Zone 3	1080	1129	1247	1283	1346	1372	1474	1540	1618	1772	2035	2133

- Exposed legs are solid hardwood
- Specify wood finish
- Seat: 19"W x 17"D x 19"H

OPTION	PRICE	CODE
Softer Seat Foam-Chair	16.00	SF

QS NOW

192_ Executive Swivel, Traditional Wood Base

30" W X 31" D X 42.5-45" H

St. Yardage: 6



Freight Class: 250
 Cubic Ft: 26
 Ship Weight: 84

Grade	1	2	3	4	5	6	7	8	9	10	L	LL
Zone 1	1648	1854	2018	2116	2174	2265	2323	2565	2714	2901	3868	4099
Zone 2	1673	1882	2048	2148	2207	2299	2358	2603	2755	2945	3926	4160
Zone 3	1697	1910	2079	2179	2239	2333	2393	2642	2795	2988	3984	4222

- Extra-high back
- Thickly padded foam seat
- Brass nail head trim on arms and seat
- 5-prong steel base with hardwood caps
- Pneumatic seat-height adjustment
- Black dual-wheel carpet casters
- Seat: 18.5"W x 19"D x 17.5-20.5"H

OPTION	PRICE	CODE
Knee Tilt Control	100.00	K
No Brass Trim Option	N/C	NB
Softer Seat Foam-Chair	16.00	SF
Edge Guard	16.00	E

CASTER	PRICE	CODE
Self-Locking Casters	85.00	S
Braking Casters	30.00	B
Hard-Floor Casters	19.00	H
Glides	N/C	GL

QS NOW

FINISH SELECTION

ROUGE MAHOGANY **RM** | MAHOGANY **MAH** | ASPEN **AP** | NATURAL **FM** |
 HONEY CHERRY **HCY** | WINDSOR CHERRY **WC** | ESPRESSO **ESP** |
 BLACK **BLK** | MOAB **MOB** | BOARDWALK **BW** | SHORELINE **SL** | DRIFTWOOD **DW** |

SIN 711-18 **SCOOP**

CONTEMPORARY OFFICE

Scoop the Competition with Style

With solid good looks and many style options, **Scoop** is a winner for any office environment. Style options include a choice between wood and urethane arms and base and a wide choice of fabrics and leathers.

Scoop Design Details

- Two back upholstery styles available: channel stitched back and original, non-stitched back
- Choose from black urethane arms and base or wood arms and base
- Built-in lumbar support

Additional Options

- Optional Knee Tilt control
- Self locking, braking or hard-floor casters

Additional Information

- Coordinating guest chairs available



Executive 1071
Management 1117



SCOOP

1001 Executive Swivel

25" W X 28.5" D X 37-40" H

St. Yardage: 3



Freight Class: 250
Cubic Ft: 21
Ship Weight: 49

Grade	1	2	3	4	5	6	7	8	9	10	L	LL
Zone 1	1143	1242	1327	1377	1451	1480	1600	1677	1770	1948	2089	2368
Zone 2	1160	1261	1347	1398	1473	1502	1624	1702	1797	1977	2120	2404
Zone 3	1177	1279	1367	1418	1495	1524	1648	1727	1823	2006	2152	2439

- Wood arms and base caps
- 5-prong steel base with hardwood caps
- Pneumatic seat-height adjustment
- Standard swivel tilt
- Dual wheel carpet casters
- Available in finishes listed
- Seat: 20"W x 19"D x 17-20.5"H

OPTION	PRICE	CODE
Knee Tilt Control	100.00	K
CASTER		
Self-Locking Casters	85.00	S
Braking Casters	30.00	B
Hard-Floor Casters	19.00	H
Glides	N/C	GL

QS NOW

1003 Arm Chair

24" W X 27" D X 33" H

St. Yardage: 2



Freight Class: 250
Cubic Ft: 15
Ship Weight: 31

Grade	1	2	3	4	5	6	7	8	9	10	L	LL
Zone 1	644	712	770	800	849	868	949	1000	1062	1180	1310	1460
Zone 2	654	723	782	812	862	881	963	1015	1078	1198	1330	1482
Zone 3	663	733	793	824	874	894	977	1030	1094	1215	1349	1504

- Wood arms/legs
- Gangable up to 4 chairs
- Price shown is per chair
- Available in the finishes listed
- Seat: 20"W x 19"D x 18.5"H

Note: Add a "C" to the product number for each ganged chair, and multiply number of chairs by correct list price. Ex: 1003CCC (3 chairs)

QS NOW

1004 Sled Base Arm Chair

24" W X 28" D X 33" H

St. Yardage: 2



Freight Class: 250
Cubic Ft: 15
Ship Weight: 33

Grade	1	2	3	4	5	6	7	8	9	10	L	LL
Zone 1	712	776	793	830	867	917	937	1017	1067	1130	1248	1529
Zone 2	723	788	805	842	880	931	951	1032	1083	1147	1267	1552
Zone 3	733	799	817	855	893	945	965	1048	1099	1164	1285	1575

- Wood arms and sled base
- Gangable up to 4 chairs
- Price shown is per chair
- Available in the finishes listed
- Seat: 20"W x 19"D x 18.5"H

Note: Add a "C" to the product number for each ganged chair, and multiply number of chairs by correct list price. Ex: 1004CCC (3 chairs)

QS NOW

T1005 Ganging Table (Table Only)

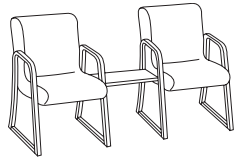

- Wood veneer table can be shipped via ground service
- Available in the finishes listed above
- Also available in black, specify T1005B

Freight Class: 70

QS NOW

			Zone Pricing	1	2	3
23" W X 15" D X 2" H	Cubic Ft: 1	Ship Weight: 10		217	220	224

1007 Management Swivel

25" W X 27" D X 32-35" H St. Yardage: 2



Freight Class: 250
 Cubic Ft: 19
 Ship Weight: 48

QS NOW

Grade	1	2	3	4	5	6	7	8	9	10	L	LL
Zone 1	980	1045	1062	1098	1136	1186	1205	1285	1336	1398	1516	1798
Zone 2	995	1061	1078	1114	1153	1204	1223	1304	1356	1419	1539	1825
Zone 3	1009	1076	1094	1131	1170	1222	1241	1324	1376	1440	1561	1852

OPTION	PRICE	CODE
Jury Base	315.00	JB
Knee Tilt Control	100.00	K

CASTER	PRICE	CODE
Self-Locking Casters	85.00	S
Braking Casters	30.00	B
Hard-Floor Casters	19.00	H
Glides	N/C	GL

- Wood arms
- 5-prong steel base with hardwood caps
- Pneumatic seat-height adjustment
- Standard swivel tilt
- Dual wheel carpet casters
- Available in finishes listed
- Seat: 20"W x 19"D x 17-20.5"H

1071 Executive Swivel

24.5" W X 28" D X 37-40" H St. Yardage: 3



Freight Class: 250
 Cubic Ft: 21
 Ship Weight: 45

QS NOW

Grade	1	2	3	4	5	6	7	8	9	10	L	LL
Zone 1	1014	1070	1136	1192	1249	1324	1352	1472	1548	1642	2185	2240
Zone 2	1029	1086	1153	1210	1268	1344	1372	1494	1571	1667	2218	2274
Zone 3	1044	1102	1170	1228	1286	1364	1393	1516	1594	1691	2251	2307

OPTION	PRICE	CODE
Knee Tilt Control	100.00	K
Edge Guard	16.00	E

CASTER	PRICE	CODE
Self-Locking Casters	85.00	S
Braking Casters	30.00	B
Hard-Floor Casters	19.00	H
Glides	N/C	GL

- Black urethane arm
- Black nylon reinforced 5-prong base
- Pneumatic seat-height adjustment
- Standard swivel tilt
- Dual wheel carpet casters
- Seat: 20"W x 19"D x 17-20.5"H

1077 Management Swivel

24.5" W X 27" D X 32-35" H St. Yardage: 2



Freight Class: 250
 Cubic Ft: 19
 Ship Weight: 43

QS NOW

Grade	1	2	3	4	5	6	7	8	9	10	L	LL
Zone 1	944	1008	1067	1121	1177	1252	1280	1401	1477	1569	1721	1940
Zone 2	958	1023	1083	1138	1195	1271	1299	1422	1499	1593	1747	1969
Zone 3	972	1038	1099	1155	1212	1290	1318	1443	1521	1616	1773	1998

OPTION	PRICE	CODE
Jury Base	315.00	JB
Knee Tilt Control	100.00	K
Edge Guard	16.00	E

CASTER	PRICE	CODE
Self-Locking Casters	85.00	S
Braking Casters	30.00	B
Hard-Floor Casters	19.00	H
Glides	N/C	GL

- Black urethane arm
- Black nylon reinforced 5-prong base
- Pneumatic seat-height adjustment
- Standard swivel tilt
- Dual wheel carpet casters
- Seat: 20"W x 19"D x 17-20.5"H

FINISH SELECTION

ROUGE MAHOGANY **RM** | MAHOGANY **MAH** | ASPEN **AP** | NATURAL **FM** |
 HONEY CHERRY **HCY** | WINDSOR CHERRY **WC** | ESPRESSO **ESP** |
 BLACK **BLK** | MOAB **MOB** | BOARDWALK **BW** | SHORELINE **SL** | DRIFTWOOD **DW** |

1091 Executive Swivel

25" W X 28.5" D X 37-40" H St. Yardage: 3



Freight Class: 250
 Cubic Ft: 21
 Ship Weight: 49

Grade	1	2	3	4	5	6	7	8	9	10	L	LL
Zone 1	1014	1070	1136	1192	1249	1324	1352	1472	1548	1642	2185	2240
Zone 2	1029	1086	1153	1210	1268	1344	1372	1494	1571	1667	2218	2274
Zone 3	1044	1102	1170	1228	1286	1364	1393	1516	1594	1691	2251	2307

- Channel style back
- Black urethane arm
- Black nylon reinforced 5-prong base
- Pneumatic seat-height adjustment
- Standard swivel tilt
- Dual wheel carpet casters
- Seat: 20"W x 19"D x 17-20.5"H

OPTION	PRICE	CODE
Knee Tilt Control	100.00	K
Edge Guard	16.00	E

CASTER	PRICE	CODE
Self-Locking Casters	85.00	S
Braking Casters	30.00	B
Hard-Floor Casters	19.00	H
Glides	N/C	GL

QS NOW

1093 Arm Chair

24" W X 27" D X 33" H St. Yardage: 3



Freight Class: 250
 Cubic Ft: 15
 Ship Weight: 26

Grade	1	2	3	4	5	6	7	8	9	10	L	LL
Zone 1	736	801	818	855	892	943	962	1041	1093	1154	1273	1555
Zone 2	747	813	830	868	905	957	976	1057	1109	1171	1292	1578
Zone 3	758	825	843	881	919	971	991	1072	1126	1189	1311	1602

- Channel style back
- Wood arms/legs
- Black (BLK) finish standard
- Gangable up to 4 chairs
- Prices shown are per chair
- Seat: 20"W x 19"D x 18.5"H

Note: Add a "C" to the product number for each ganged chair, and multiply number of chairs by correct list price. Ex: 1093CCC (3 chairs)

QS NOW

1094 Sled Base Arm Chair

24" W X 27" D X 33" H St. Yardage: 2



Freight Class: 250
 Cubic Ft: 15
 Ship Weight: 33

Grade	1	2	3	4	5	6	7	8	9	10	L	LL
Zone 1	802	839	884	920	957	1007	1028	1107	1158	1220	1452	1619
Zone 2	814	852	897	934	971	1022	1043	1124	1175	1238	1474	1643
Zone 3	826	864	911	948	986	1037	1059	1140	1193	1257	1496	1668

- Channel style back
- Wood arms and sled base
- Black (BLK) finish standard
- Gangable up to 4 chairs
- Prices shown are per chair
- Seat: 20"W x 19"D x 18.5"H

Note: Add a "C" to the product number for each ganged chair, and multiply number of chairs by correct list price. Ex: 1094CCC (3 chairs)

QS NOW

1097 Management Swivel

24.5" W X 27" D X 32-35" H St. Yardage: 2



Freight Class: 250
 Cubic Ft: 19
 Ship Weight: 46

Grade	1	2	3	4	5	6	7	8	9	10	L	LL
Zone 1	973	1010	1055	1092	1130	1179	1197	1278	1329	1390	1508	1790
Zone 2	988	1025	1071	1108	1147	1197	1215	1297	1349	1411	1531	1817
Zone 3	1002	1040	1087	1125	1164	1214	1233	1316	1369	1432	1553	1844

- Channel style back
- Black urethane arm
- Black nylon reinforced 5-prong base
- Pneumatic seat-height adjustment
- Standard swivel tilt
- Dual wheel carpet casters
- Seat: 20"W x 19"D x 17-20.5"H

OPTION	PRICE	CODE
Jury Base	315.00	JB
Knee Tilt Control	100.00	K
Edge Guard	16.00	E

CASTER	PRICE	CODE
Self-Locking Casters	85.00	S
Braking Casters	30.00	B
Hard-Floor Casters	19.00	H
Glides	N/C	GL

QS NOW

1111 Executive Swivel

25" W X 28.5" D X 37-40" H

St. Yardage: 3



Freight Class: 250
 Cubic Ft: 21
 Ship Weight: 49

Grade	1	2	3	4	5	6	7	8	9	10	L	LL
Zone 1	1158	1253	1279	1336	1391	1467	1496	1616	1691	1784	1961	2343
Zone 2	1175	1272	1298	1356	1412	1489	1518	1640	1716	1811	1990	2378
Zone 3	1193	1291	1317	1376	1433	1511	1541	1664	1742	1838	2020	2413

- Standard swivel tilt
- Channel style back
- Wood arms available in the finishes listed
- 5-prong steel base with hardwood caps and dual wheel casters
- Pneumatic seat-height adjustment
- Seat: 20"W x 19"D x 17-20.5"H

OPTION	PRICE	CODE
Knee Tilt Control	100.00	K
Edge Guard	16.00	E

CASTER	PRICE	CODE
Self-Locking Casters	85.00	S
Braking Casters	30.00	B
Hard-Floor Casters	19.00	H
Glides	N/C	GL

QS NOW

1113 Arm Chair

24" W X 27" D X 33" H

St. Yardage: 2



Freight Class: 250
 Cubic Ft: 15
 Ship Weight: 31

Grade	1	2	3	4	5	6	7	8	9	10	L	LL
Zone 1	649	687	731	768	805	855	875	954	1005	1067	1186	1440
Zone 2	659	697	742	780	817	868	888	968	1020	1083	1204	1462
Zone 3	668	708	753	791	829	881	901	983	1035	1099	1222	1483

- Channel style back
- Wood arms/legs available in the finishes listed
- Gangable up to 4 chairs
- Seat: 20"W x 19"D x 18.5"H

Note: Add a "C" to the product number for each ganged chair, and multiply number of chairs by correct list price. Ex: 1113CCC (3 chairs)

QS NOW

1114 Sled Base Arm Chair

24" W X 27" D X 33" H

St. Yardage: 2



Freight Class: 250
 Cubic Ft: 15
 Ship Weight: 33

Grade	1	2	3	4	5	6	7	8	9	10	L	LL
Zone 1	718	782	800	836	875	923	944	1024	1074	1136	1254	1505
Zone 2	729	794	812	849	888	937	958	1039	1090	1153	1273	1528
Zone 3	740	805	824	861	901	951	972	1055	1106	1170	1292	1550

- Channel style back
- Wood arms and sled base
- Available in the finishes listed
- Gangable up to 4 chairs
- Price shown is per chair
- Seat: 20"W x 19"D x 18.5"H

Note: Add a "C" to the product number for each ganged chair, and multiply number of chairs by correct list price. Ex: 1114CCC (3 chairs)

QS NOW

1117 Management Swivel

25" W X 27" D X 32-35" H

St. Yardage: 2



Freight Class: 250
 Cubic Ft: 19
 Ship Weight: 46

Grade	1	2	3	4	5	6	7	8	9	10	L	LL
Zone 1	992	1060	1073	1110	1147	1196	1217	1297	1347	1410	1528	1781
Zone 2	1007	1076	1089	1127	1164	1214	1235	1316	1367	1431	1551	1808
Zone 3	1022	1092	1105	1143	1181	1232	1254	1336	1387	1452	1574	1834

- Channel style back
- Wood arms
- 5-prong steel base with hardwood caps and dual wheel casters
- Pneumatic seat-height adjustment
- Available in finishes listed
- Standard swivel tilt
- Seat: 20"W x 19"D x 17-20.5"H

OPTION	PRICE	CODE
Jury Base	315.00	JB
Knee Tilt Control	100.00	K
Edge Guard	16.00	E

CASTER	PRICE	CODE
Self-Locking Casters	85.00	S
Braking Casters	30.00	B
Hard-Floor Casters	19.00	H
Glides	N/C	GL

QS NOW

Four Unique Designs

1200 Series office seating includes four unique contemporary seating designs ergonomically shaped for lumbar support, proper posture and long-term comfort.



1231 Executive

Design Details

- **1210s**— dual-cushion appearance, wood arms, 5-prong steel base with hardwood caps
- **1220s**— thin profile, horizontal back stitching, black urethane arms/base, large scale
- **1230s**— polished chrome base with dual wheel casters, polished chrome arms with black urethane armcap, knee tilt standard
- **1240s**— thin profile with horizontal back stitching, wood arms with upholstered arm cap, 5-prong steel base with hardwood caps



1200 SERIES

1211 Executive Swivel

23" W X 28" D X 41-44" H

St. Yardage: 4.5



Freight Class: 250
Cubic Ft: 26
Ship Weight: 50

Grade	1	2	3	4	5	6	7	8	9	10	L	LL
Zone 1	1777	1862	1959	2043	2129	2241	2284	2464	2577	2718	2985	3540
Zone 2	1804	1890	1988	2074	2161	2275	2318	2501	2616	2759	3030	3593
Zone 3	1830	1918	2018	2104	2193	2308	2353	2538	2654	2800	3075	3646

- Wood arms
- 5-prong steel base with hardwood caps
- Pneumatic seat-height adjustment
- Standard swivel tilt
- Dual wheel carpet casters
- Seat: 19"W x 18"D x 18-21"H

OPTION	PRICE	CODE
Knee Tilt Control	100.00	K
Edge Guard	16.00	E
Upholstered Arm Caps	114.00	UA
CASTER	PRICE	CODE
Self-Locking Casters	85.00	S
Braking Casters	30.00	B
Hard-Floor Casters	19.00	H
Glides	N/C	GL

QS NOW

1217 Management Swivel

23" W X 27" D X 36-39" H

St. Yardage: 3.8



Freight Class: 250
Cubic Ft: 19
Ship Weight: 46

Grade	1	2	3	4	5	6	7	8	9	10	L	LL
Zone 1	1648	1719	1802	1872	1945	2039	2076	2228	2324	2443	2667	3101
Zone 2	1673	1745	1829	1900	1974	2070	2107	2261	2359	2480	2707	3148
Zone 3	1697	1771	1856	1928	2003	2100	2138	2295	2394	2516	2747	3194

- Wood arms
- 5-prong steel base with hardwood caps
- Standard swivel tilt
- Dual wheel carpet casters
- Pneumatic seat-height adjustment
- Available in the finishes above
- Seat: 19"W x 18"D x 18-21"H

OPTION	PRICE	CODE
Jury Base	315.00	JB
Knee Tilt Control	100.00	K
Edge Guard	16.00	E
Upholstered Arm Caps	114.00	UA
CASTER	PRICE	CODE
Self-Locking Casters	85.00	S
Braking Casters	30.00	B
Hard-Floor Casters	19.00	H
Glides	N/C	GL

QS NOW

1221 Executive Swivel

25" W X 29" D X 41-44" H

St. Yardage: 2.75



Freight Class: 250
 Cubic Ft: 23
 Ship Weight: 50

Grade	1	2	3	4	5	6	7	8	9	10	L	LL
Zone 1	1338	1445	1472	1538	1595	1678	1710	1841	1924	2028	2223	2591
Zone 2	1358	1467	1494	1561	1619	1703	1736	1869	1953	2058	2256	2630
Zone 3	1378	1488	1516	1584	1643	1728	1761	1896	1982	2089	2290	2669

- Black urethane arm
- Black nylon reinforced 5-prong base
- Pneumatic seat-height adjustment
- Standard swivel tilt
- Dual wheel carpet casters
- Seat: 20.25"W x 19.75"D x 18.5-22"H

OPTION	PRICE	CODE
Knee Tilt Control	100.00	K
Edge Guard	16.00	E
CASTER	PRICE	CODE
Self-Locking Casters	85.00	S
Braking Casters	30.00	B
Hard-Floor Casters	19.00	H
Glides	N/C	GL

QS NOW

1227 Management Swivel

25" W X 27" D X 35-38" H

St. Yardage: 2.5



Freight Class: 250
 Cubic Ft: 19
 Ship Weight: 46

Grade	1	2	3	4	5	6	7	8	9	10	L	LL
Zone 1	1232	1314	1388	1427	1489	1513	1615	1677	1754	1902	2054	2204
Zone 2	1250	1334	1409	1448	1511	1536	1639	1702	1780	1931	2085	2237
Zone 3	1269	1353	1430	1470	1534	1558	1663	1727	1807	1959	2116	2270

- Black urethane arm
- Black nylon reinforced 5-prong base
- Pneumatic seat-height adjustment
- Standard swivel tilt
- Dual wheel carpet casters
- Seat: 20.25"W x 19.75"D x 18.5-22"H

OPTION	PRICE	CODE
Jury Base	315.00	JB
Knee Tilt Control	100.00	K
Edge Guard	16.00	E
CASTER	PRICE	CODE
Self-Locking Casters	85.00	S
Braking Casters	30.00	B
Hard-Floor Casters	19.00	H
Glides	N/C	GL

QS NOW

1231 Executive Swivel

24.5" W X 27.5" D X 41-44" H

St. Yardage: 2.75



Freight Class: 250
 Cubic Ft: 23
 Ship Weight: 50

Grade	1	2	3	4	5	6	7	8	9	10	L	LL
Zone 1	1367	1482	1580	1640	1726	1761	1901	1988	2098	2305	2723	2796
Zone 2	1388	1504	1604	1665	1752	1787	1930	2018	2129	2340	2764	2838
Zone 3	1408	1526	1627	1689	1778	1814	1958	2048	2161	2374	2805	2880

- Polished chrome arms with black urethane arm caps
- Polished chrome base with dual wheel casters
- Knee tilt control standard (No additional control options on this model)
- Pneumatic seat-height adjustment
- Seat: 20"W x 20"D x 18.5-21.5"H

OPTION	PRICE	CODE
Edge Guard	16.00	E
CASTER	PRICE	CODE
Self-Locking Casters	85.00	S
Braking Casters	30.00	B
Hard-Floor Casters	19.00	H
Glides	N/C	GL

QS NOW

FINISH SELECTION

ASPEN **AP** | ROUGE MAHOGANY **RM** | MAHOGANY **MAH** | NATURAL **FM** |
 HONEY CHERRY **HCY** | ESPRESSO **ESP** | MOAB **MOB** | BLACK **BLK** |
 WINDSOR CHERRY **WC** | BOARDWALK **BW** | SHORELINE **SL** | DRIFTWOOD **DW** |

SIN 711-18 **1200 SERIES**

CONTEMPORARY OFFICE

1237 Management Swivel

24.5" W X 26" D X 36-39" H

St. Yardage: 2.5



Freight Class: 250
 Cubic Ft: 19
 Ship Weight: 46

Grade	1	2	3	4	5	6	7	8	9	10	L	LL
Zone 1	1248	1344	1430	1481	1557	1585	1672	1781	1873	2052	2401	2474
Zone 2	1267	1364	1451	1503	1580	1609	1697	1808	1901	2083	2437	2511
Zone 3	1285	1384	1473	1525	1604	1633	1722	1834	1929	2114	2473	2548

- Polished chrome arms with black urethane arm caps
- Polished chrome base with dual wheel casters
- Knee tilt control standard (No additional control options on this model)
- Pneumatic seat-height adjustment
- Seat: 20"W x 20"D x 18.5-21.5"H

OPTION	PRICE	CODE
Jury Base	315.00	JB
Edge Guard	16.00	E
CASTER	PRICE	CODE
Self-Locking Casters	85.00	S
Braking Casters	30.00	B
Hard-Floor Casters	19.00	H
Glides	N/C	GL

QS NOW

1241 Executive Swivel

24" W X 28" D X 42-46" H

St. Yardage: 2.75



Freight Class: 250
 Cubic Ft: 26
 Ship Weight: 50

Grade	1	2	3	4	5	6	7	8	9	10	L	LL
Zone 1	1180	1294	1399	1452	1539	1572	1715	1802	1911	2118	2595	2839
Zone 2	1198	1313	1420	1474	1562	1596	1741	1829	1940	2150	2634	2882
Zone 3	1215	1333	1441	1496	1585	1619	1766	1856	1968	2182	2673	2924

- Wood arms
- 5-prong steel base with hardwood caps
- Pneumatic seat-height adjustment
- Standard swivel tilt
- Dual wheel carpet casters
- Seat: 19"W x 18"D x 18-21"H

OPTION	PRICE	CODE
Knee Tilt Control	100.00	K
Edge Guard	16.00	E
CASTER	PRICE	CODE
Self-Locking Casters	85.00	S
Braking Casters	30.00	B
Hard-Floor Casters	19.00	H
Glides	N/C	GL

QS NOW

1247 Management Swivel

24" W X 26" D X 34-38" H

St. Yardage: 2.5



Freight Class: 250
 Cubic Ft: 26
 Ship Weight: 50

Grade	1	2	3	4	5	6	7	8	9	10	L	LL
Zone 1	1130	1234	1317	1364	1439	1467	1554	1662	1755	1933	2347	2471
Zone 2	1147	1253	1337	1384	1461	1489	1577	1687	1781	1962	2382	2508
Zone 3	1164	1271	1357	1405	1482	1511	1601	1712	1808	1991	2417	2545

- Wood arms with upholstered arm caps
- 5-prong steel base with hardwood caps
- Dual wheel casters
- Pneumatic seat-height adjustment
- Standard swivel tilt
- Available in the finishes above
- Seat: 19"W x 19"D x 17.5-21"H

OPTION	PRICE	CODE
Jury Base	315.00	JB
Knee Tilt Control	100.00	K
Edge Guard	16.00	E
CASTER	PRICE	CODE
Self-Locking Casters	85.00	S
Braking Casters	30.00	B
Hard-Floor Casters	19.00	H
Glides	N/C	GL

QS NOW

Three Winning Designs

Trifecta 1600 Series presents executive-level style, comfort and value in three distinct arm designs: Fully Upholstered, Wood Arms/Base and Black Textured Resin Arms/Base.

Design Details

- *Pronounced backrest and lumbar support enhance comfort*
- *Seats feature thick, multi-density foam and seat suspensions that conform to the individual*
- *Waterfall front seat edges provide proper leg support*

Additional Information

- *Quick Ship available in 60+ upholsteries*
- *Limited Lifetime Warranty on all chairs*



1621 Executive



1627 Management



1641 Executive



TRIFECTA

1621 Executive Swivel

24" W X 30" D X 44-48" H

St. Yardage: 4



Freight Class: 250
 Cubic Ft: 24
 Ship Weight: 56

Grade	1	2	3	4	5	6	7	8	9	10	L	LL
Zone 1	1314	1440	1544	1608	1701	1737	1888	1982	2099	2271	2320	2781
Zone 2	1334	1462	1567	1632	1727	1763	1916	2012	2130	2305	2355	2823
Zone 3	1353	1483	1590	1656	1752	1789	1945	2041	2162	2339	2390	2864

- Wood arms
- 5-prong steel base with hardwood caps
- Pneumatic seat-height adjustment
- Standard swivel tilt
- Dual wheel casters
- Weight capacity 250 lbs
- Available in finishes listed
- Seat: 19"W x 18"D x 18.5-22.5"H

OPTION	PRICE	CODE
Knee Tilt Control	100.00	K
Edge Guard	16.00	E

CASTER	PRICE	CODE
Self-Locking Casters	85.00	S
Braking Casters	30.00	B
Hard-Floor Casters	19.00	H
Glides	N/C	GL

QS NOW

1624 Side Chair

24.5" W X 30" D X 34.5" H

St. Yardage: 3.25



Freight Class: 250
 Cubic Ft: 21
 Ship Weight: 34

Grade	1	2	3	4	5	6	7	8	9	10	L	LL
Zone 1	1104	1161	1226	1297	1357	1439	1470	1600	1681	1783	1925	2091
Zone 2	1121	1178	1244	1316	1377	1461	1492	1624	1706	1810	1954	2122
Zone 3	1137	1196	1263	1336	1398	1482	1514	1648	1731	1836	1983	2154

- Wood arms/base
- Thick cushioned backrest with built in lumbar support
- Seat: 21"W x 20"D x 21"H

QS NOW

FINISH SELECTION

ROUGE MAHOGANY **RM** | MAHOGANY **MAH** | ASPEN **AP** | NATURAL **FM** |
 HONEY CHERRY **HCY** | ESPRESSO **ESP** | MOAB **MOB** | WINDSOR CHERRY **WC** |
 BOARDWALK **BW** | SHORELINE **SL** | DRIFTWOOD **DW** |

SIN 711-18 TRIFECTA

CONTEMPORARY OFFICE

1627 Management Swivel

24" W X 28" D X 34-38" H

St. Yardage: 4



Freight Class: 250
 Cubic Ft: 21
 Ship Weight: 56

Grade	1	2	3	4	5	6	7	8	9	10	L	LL
Zone 1	1211	1314	1412	1465	1543	1577	1639	1708	1787	1890	2082	2481
Zone 2	1229	1334	1433	1487	1566	1601	1664	1734	1814	1918	2113	2518
Zone 3	1247	1353	1454	1509	1589	1624	1688	1759	1841	1947	2144	2555

- Wood arms
- 5-prong steel base with hardwood caps
- Pneumatic seat-height adjustment
- Standard swivel tilt
- Weight capacity 250 lbs
- Dual wheel casters
- Seat: 19"W x 18"D x 18.5-22.5"H

OPTION	PRICE	CODE
Jury Base	315.00	JB
Knee Tilt Control	100.00	K
Edge Guard	16.00	E

CASTER	PRICE	CODE
Self-Locking Casters	85.00	S
Braking Casters	30.00	B
Hard-Floor Casters	19.00	H
Glides	N/C	GL

QS NOW

1641 Executive Swivel

26.5" W X 30" D X 44-48" H

St. Yardage: 5



Freight Class: 250
 Cubic Ft: 24
 Ship Weight: 65

Grade	1	2	3	4	5	6	7	8	9	10	L	LL
Zone 1	1486	1649	1792	1875	2000	2049	2149	2251	2374	2531	2826	3438
Zone 2	1508	1674	1819	1903	2030	2080	2181	2285	2410	2569	2868	3490
Zone 3	1531	1698	1846	1931	2060	2110	2213	2319	2445	2607	2911	3541

- Upholstered arms
- 5-prong steel base with hardwood caps
- Pneumatic seat-height adjustment
- Standard swivel tilt
- Weight capacity 300 lbs
- Dual wheel casters
- Seat: 19"W x 18"D x 18.5-22.5"H

OPTION	PRICE	CODE
Knee Tilt Control	100.00	K
Edge Guard	16.00	E

CASTER	PRICE	CODE
Self-Locking Casters	85.00	S
Braking Casters	30.00	B
Hard-Floor Casters	19.00	H
Glides	N/C	GL

QS NOW

1647 Management Swivel

26.5" W X 28" D X 34-38" H

St. Yardage: 4.5



Freight Class: 250
 Cubic Ft: 19
 Ship Weight: 55

Grade	1	2	3	4	5	6	7	8	9	10	L	LL
Zone 1	1389	1535	1666	1742	1798	1854	1896	2077	2190	2330	2597	3142
Zone 2	1410	1558	1691	1768	1825	1882	1924	2108	2223	2365	2636	3189
Zone 3	1431	1581	1716	1794	1852	1910	1953	2139	2256	2400	2675	3236

- Upholstered arms
- 5-prong steel base with hardwood caps
- Pneumatic seat-height adjustment
- Standard swivel tilt
- Weight capacity 300 lbs
- Dual wheel casters
- Seat: 19"W x 18"D x 18.5-22.5"H

OPTION	PRICE	CODE
Jury Base	315.00	JB
Knee Tilt Control	100.00	K
Edge Guard	16.00	E

CASTER	PRICE	CODE
Self-Locking Casters	85.00	S
Braking Casters	30.00	B
Hard-Floor Casters	19.00	H
Glides	N/C	GL

QS NOW

1661 Executive Swivel

24" W X 30" D X 44-48" H

St. Yardage: 4



Freight Class: 250
 Cubic Ft: 24
 Ship Weight: 54

Grade	1	2	3	4	5	6	7	8	9	10	L	LL
Zone 1	1314	1440	1544	1608	1701	1737	1811	1888	1982	2099	2435	2781
Zone 2	1334	1462	1567	1632	1727	1763	1838	1916	2012	2130	2472	2823
Zone 3	1353	1483	1590	1656	1752	1789	1865	1945	2041	2162	2508	2864

- Black urethane arms
- Black nylon reinforced 5-prong base
- Pneumatic seat-height adjustment
- Standard swivel tilt
- Dual wheel casters
- Seat: 19"W x 18"D x 18.5-22.5"H

OPTION	PRICE	CODE
Knee Tilt Control	100.00	K
Edge Guard	16.00	E

CASTER	PRICE	CODE
Self-Locking Casters	85.00	S
Braking Casters	30.00	B
Hard-Floor Casters	19.00	H
Glides	N/C	GL

QS NOW

1667 Management Swivel

24" W X 28" D X 34-38" H

St. Yardage: 4



Freight Class: 250
 Cubic Ft: 19
 Ship Weight: 45

Grade	1	2	3	4	5	6	7	8	9	10	L	LL
Zone 1	1211	1314	1412	1465	1543	1577	1643	1708	1787	1890	2197	2481
Zone 2	1229	1334	1433	1487	1566	1601	1668	1734	1814	1918	2230	2518
Zone 3	1247	1353	1454	1509	1589	1624	1692	1759	1841	1947	2263	2555

- Black urethane arms
- Black nylon reinforced 5-prong base
- Pneumatic seat-height adjustment
- Standard swivel tilt
- Dual wheel casters
- Seat: 19"W x 18"D x 18.5-22.5"H

OPTION	PRICE	CODE
Jury Base	315.00	JB
Knee Tilt Control	100.00	K
Edge Guard	16.00	E

CASTER	PRICE	CODE
Self-Locking Casters	85.00	S
Braking Casters	30.00	B
Hard-Floor Casters	19.00	H
Glides	N/C	GL

QS NOW

FINISH SELECTION

ASPEN **AP** | BLACK **BLK** | BOARDWALK **BW** | ESPRESSO **ESP** | HONEY CHERRY **HCY** | MAHOGANY **MAH** | MOAB **MOB** | NATURAL **FM** | ROUGE MAHOGANY **RM** | WINDSOR CHERRY **WC** | SHORELINE **SL** | DRIFTWOOD **DW** |

SIN 711-18 QUICK SILVER

CONTEMPORARY OFFICE

Four Designs, One Ergonomic Comfort

Quick Silver begins with an ergonomically shaped lumbar design, contoured to promote proper posture for comfort and long-term back support. Waterfall front seat edges provide freedom of movement and reduce stress on legs. All four Quick Silver designs incorporate these features in Executive, Management and Guest chair selections. Guest seating is also available.

Design Details

- **1270s** – double trapezoid back stitching; upholstered arm caps on wood arms
- **1830s** – horizontal back stitching; all-wood arms
- **3200s** – flared vertical back stitching; upholstered arm caps on wood arms; swivel chairs also available with black base and arms

Additional Features

- *Pneumatic seat-height adjustment standard*
- *Tilt-tension adjustment standard*
- *Extensive Standard & Quick Ship Upholsteries*
- *Limited Lifetime Warranty*



1271 Executive



1831 Executive



3271 Executive

Quick Silver

1271 Executive Swivel



Freight Class: 250
Cubic Ft: 23
Ship Weight: 59

24" W X 28" D X 42-46" H

St. Yardage: 3

Grade	1	2	3	4	5	6	7	8	9	10	L	LL
Zone 1	1132	1241	1327	1385	1466	1498	1563	1628	1709	1810	2232	2399
Zone 2	1149	1260	1347	1406	1488	1520	1586	1652	1735	1837	2265	2435
Zone 3	1166	1278	1367	1427	1510	1543	1610	1677	1760	1864	2299	2471

- Wood arms with upholstered arm caps
- 5-prong steel base with hardwood caps
- Dual wheel casters
- Pneumatic seat-height adjustment
- Standard swivel tilt
- Seat: 19.5"W x 18.75"D x 17-20.5"H

OPTION	PRICE	CODE
Knee Tilt Control	100.00	K
Edge Guard	16.00	E
CASTER	PRICE	CODE
Self-Locking Casters	85.00	S
Braking Casters	30.00	B
Hard-Floor Casters	19.00	H
Glides	N/C	GL

QS NOW

1274 Arm Chair



Freight Class: 250
Cubic Ft: 14
Ship Weight: 29

24" W X 26" D X 33" H

St. Yardage: 2.5

Grade	1	2	3	4	5	6	7	8	9	10	L	LL
Zone 1	940	982	1033	1086	1134	1195	1220	1321	1383	1460	1569	1787
Zone 2	954	997	1048	1102	1151	1213	1238	1341	1404	1482	1593	1814
Zone 3	968	1011	1064	1119	1168	1231	1257	1361	1424	1504	1616	1841

- Wood arms/base
- Double trapezoid back stitching
- Seat: 19.5"W x 18"D x 18.5"H

QS NOW

1277 Management Swivel



Freight Class: 250
Cubic Ft: 19
Ship Weight: 51

24" W X 26" D X 34-38" H

St. Yardage: 2.5

Grade	1	2	3	4	5	6	7	8	9	10	L	LL
Zone 1	1084	1165	1241	1279	1341	1366	1420	1467	1529	1607	2060	2221
Zone 2	1100	1182	1260	1298	1361	1386	1441	1489	1552	1631	2091	2254
Zone 3	1117	1200	1278	1317	1381	1407	1463	1511	1575	1655	2122	2288

- Wood arms with upholstered arm caps
- 5-prong steel base with wood caps
- Dual wheel casters
- Pneumatic seat-height adjustment
- Standard swivel tilt
- Seat: 19.5"W x 18.75"D x 17-20.5"H

OPTION	PRICE	CODE
Jury Base	315.00	JB
Knee Tilt Control	100.00	K
Edge Guard	16.00	E
CASTER	PRICE	CODE
Self-Locking Casters	85.00	S
Braking Casters	30.00	B
Hard-Floor Casters	19.00	H
Glides	N/C	GL

QS NOW

1831 Executive Swivel

25" W X 28" D X 41-44.5" H

St. Yardage: 3



Freight Class: 250
 Cubic Ft: 23
 Ship Weight: 55

Grade	1	2	3	4	5	6	7	8	9	10	L	LL
Zone 1	1132	1241	1327	1385	1466	1498	1563	1628	1709	1810	2232	2399
Zone 2	1149	1260	1347	1406	1488	1520	1586	1652	1735	1837	2265	2435
Zone 3	1166	1278	1367	1427	1510	1543	1610	1677	1760	1864	2299	2471

- Wood arms
- 5-prong steel base with hardwood caps and dual wheel casters
- Pneumatic seat-height adjustment
- Standard swivel tilt
- Available in the finishes listed above
- Seat: 19.5"W x 18.75"D x 17.5-21"H

OPTION	PRICE	CODE
--------	-------	------

Knee Tilt Control	100.00	K
Edge Guard	16.00	E

CASTER	PRICE	CODE
--------	-------	------

Self-Locking Casters	85.00	S
Braking Casters	30.00	B
Hard-Floor Casters	19.00	H
Glides	N/C	GL

QS NOW

1834 Side Chair

24" W X 26" D X 33" H

St. Yardage: 2.5



Freight Class: 250
 Cubic Ft: 14
 Ship Weight: 28

Grade	1	2	3	4	5	6	7	8	9	10	L	LL
Zone 1	992	1047	1114	1140	1187	1249	1273	1373	1437	1513	1812	2013
Zone 2	1007	1063	1131	1157	1205	1268	1292	1394	1459	1536	1839	2043
Zone 3	1022	1078	1147	1174	1223	1286	1311	1414	1480	1558	1866	2073

- Wood arms/legs
- Horizontal back stitching
- Seat: 19.5"W x 18.75"D x 18.5"H

QS NOW

1837 Management Swivel

25" W X 26" D X 34-38" H

St. Yardage: 2.5



Freight Class: 250
 Cubic Ft: 19
 Ship Weight: 51

Grade	1	2	3	4	5	6	7	8	9	10	L	LL
Zone 1	1084	1165	1241	1279	1341	1366	1420	1467	1529	1607	2060	2221
Zone 2	1100	1182	1260	1298	1361	1386	1441	1489	1552	1631	2091	2254
Zone 3	1117	1200	1278	1317	1381	1407	1463	1511	1575	1655	2122	2288

- Wood arms
- 5-prong steel base with hardwood caps
- Dual wheel casters
- Pneumatic seat-height adjustment
- Standard swivel tilt
- Available in the finishes listed above
- Seat: 19.5" W x 18.75" D x 17.5-21" H

OPTION	PRICE	CODE
--------	-------	------

Jury Base	315.00	JB
Knee Tilt Control	100.00	K
Edge Guard	16.00	E

CASTER	PRICE	CODE
--------	-------	------

Self-Locking Casters	85.00	S
Braking Casters	30.00	B
Hard-Floor Casters	19.00	H
Glides	N/C	GL

QS NOW

3271 Executive Swivel

24" W X 28" D X 41-44.5" H

St. Yardage: 3



Freight Class: 250
 Cubic Ft: 23
 Ship Weight: 55

Grade	1	2	3	4	5	6	7	8	9	10	L	LL
Zone 1	1154	1264	1352	1409	1488	1521	1583	1662	1732	1834	2027	2447
Zone 2	1171	1283	1372	1430	1510	1544	1607	1687	1758	1862	2057	2484
Zone 3	1189	1302	1393	1451	1533	1567	1630	1712	1784	1889	2088	2520

- Wood arms with upholstered arm caps
- 5-prong steel base with hardwood caps
- Pneumatic seat-height adjustment
- Standard swivel tilt
- Seat: 19.5"W x 18.75"D x 16-19.75"H

OPTION	PRICE	CODE
--------	-------	------

Knee Tilt Control	100.00	K
Edge Guard	16.00	E

CASTER	PRICE	CODE
--------	-------	------

Self-Locking Casters	85.00	S
Braking Casters	30.00	B
Hard-Floor Casters	19.00	H
Glides	N/C	GL

QS NOW

FINISH SELECTION

ASPEN **AP** | BLACK **BLK** | BOARDWALK **BW** | ESPRESSO **ESP** | HONEY CHERRY **HCY** | MAHOGANY **MAH** | MOAB **MOB** | NATURAL **FM** | ROUGE MAHOGANY **RM** | WINDSOR CHERRY **WC** | SHORELINE **SL** | DRIFTWOOD **DW** |

SIN 711-18 **QUICK SILVER**

CONTEMPORARY OFFICE

3274 Side Chair

24" W X 26" D X 33" H St. Yardage: 2.5



Freight Class: 250
Cubic Ft: 14
Ship Weight: 29

Grade	1	2	3	4	5	6	7	8	9	10	L	LL
Zone 1	1009	1067	1133	1158	1205	1266	1291	1391	1453	1532	1832	2031
Zone 2	1024	1083	1150	1175	1223	1285	1310	1412	1475	1555	1859	2061
Zone 3	1039	1099	1167	1193	1241	1304	1330	1433	1497	1578	1887	2092

- Wood arms/legs
- Flared back stitching
- Seat: 19.5"W x 18.75"D x 18.5"H

QS NOW

3277 Management Swivel

24" W X 26" D X 32-36" H St. Yardage: 2.5



Freight Class: 250
Cubic Ft: 19
Ship Weight: 51

Grade	1	2	3	4	5	6	7	8	9	10	L	LL
Zone 1	1107	1188	1264	1313	1365	1388	1440	1489	1553	1630	1892	2101
Zone 2	1124	1206	1283	1333	1385	1409	1462	1511	1576	1654	1920	2133
Zone 3	1140	1224	1302	1352	1406	1430	1483	1534	1600	1679	1949	2164

- Wood arms with upholstered arm caps
- Pneumatic seat-height adjustment
- 5-prong steel base with hardwood caps
- Standard swivel tilt
- Seat: 19.5"W x 18.75"D x 16-19.75"H

OPTION	PRICE	CODE
Jury Base	315.00	JB
Knee Tilt Control	100.00	K
Edge Guard	16.00	E
CASTER	PRICE	CODE
Self-Locking Casters	85.00	S
Braking Casters	30.00	B
Hard-Floor Casters	19.00	H
Glides	N/C	GL

QS NOW

3201 Executive Swivel

25" W X 28" D X 41-44.5" H St. Yardage: 3



Freight Class: 250
Cubic Ft: 23
Ship Weight: 55

Grade	1	2	3	4	5	6	7	8	9	10	L	LL
Zone 1	1154	1264	1352	1409	1488	1521	1583	1662	1732	1834	2027	2447
Zone 2	1171	1283	1372	1430	1510	1544	1607	1687	1758	1862	2057	2484
Zone 3	1189	1302	1393	1451	1533	1567	1630	1712	1784	1889	2088	2520

- Black urethane arms
- Black nylon reinforced 5-prong base
- Pneumatic seat-height adjustment
- Standard swivel tilt
- Seat: 19.5"W x 18.75"D x 16-19.75"H

OPTION	PRICE	CODE
Knee Tilt Control	100.00	K
Edge Guard	16.00	E
CASTER	PRICE	CODE
Self-Locking Casters	85.00	S
Braking Casters	30.00	B
Hard-Floor Casters	19.00	H
Glides	N/C	GL

QS NOW

3207 Management Swivel

25" W X 26" D X 32-36" H St. Yardage: 2.5



Freight Class: 250
Cubic Ft: 19
Ship Weight: 51

Grade	1	2	3	4	5	6	7	8	9	10	L	LL
Zone 1	1107	1188	1264	1313	1365	1388	1440	1489	1553	1630	1892	2101
Zone 2	1124	1206	1283	1333	1385	1409	1462	1511	1576	1654	1920	2133
Zone 3	1140	1224	1302	1352	1406	1430	1483	1534	1600	1679	1949	2164

- Black urethane arms
- Black nylon reinforced 5-prong base
- Pneumatic seat height adjustment
- Standard swivel tilt
- Seat: 19.5"W x 18.75"D x 16-19.75"H

OPTION	PRICE	CODE
Jury Base	315.00	JB
Knee Tilt Control	100.00	K
Edge Guard	16.00	E
CASTER	PRICE	CODE
Self-Locking Casters	85.00	S
Braking Casters	30.00	B
Hard-Floor Casters	19.00	H
Glides	N/C	GL

QS NOW

Generous Proportions

3900 Series full-size contemporary executive seating features extended seat width and seat depth with contoured lumbar support for increased comfort. Generously proportioned, 3900 includes executive and management height models with wood arms and upholstered accent or with pliable, durable black urethane arms.

Design Details

- Wood arm chairs available in all finishes
- All chairs feature pillow cushioning for soft, plush comfort
- Front seat edges provide proper leg support

Additional Features

- Pneumatic seat-height adjustment standard
- Tilt-tension adjustment standard
- Optional knee tilt control
- Extensive Standard & Quick Ship upholsteries
- Limited Lifetime Warranty



Management 3907



Executive 3901



Executive 3921

3900 Series

3901 Executive Swivel

24.25" W X 26" D X 44-48" H

St. Yardage: 4.25



Freight Class: 250
 Cubic Ft: 23
 Ship Weight: 56

Grade	1	2	3	4	5	6	7	8	9	10	L	LL
Zone 1	1307	1437	1564	1658	1771	1812	1994	2107	2247	2514	2859	3046
Zone 2	1327	1459	1587	1683	1798	1839	2024	2139	2281	2552	2902	3092
Zone 3	1346	1480	1611	1708	1824	1866	2054	2170	2314	2589	2945	3137

- Oversized seat and back
- Wood arms with upholstered accent
- 5-prong steel base with hardwood caps
- Weight capacity 250 lbs
- Standard swivel tilt
- See series overview above
- Seat: 21"W x 20.5"D x 18.25-22.25"H

OPTION	PRICE	CODE
Knee Tilt Control	100.00	K
Edge Guard	16.00	E

CASTER	PRICE	CODE
Self-Locking Casters	85.00	S
Braking Casters	30.00	B
Hard-Floor Casters	19.00	H
Glides	N/C	GL

QS NOW

3904 Side Chair

24" W X 26" D X 33" H

St. Yardage: 3.75



Freight Class: 250
 Cubic Ft: 15
 Ship Weight: 33

Grade	1	2	3	4	5	6	7	8	9	10	L	LL
Zone 1	1175	1231	1298	1426	1506	1613	1653	1826	1929	2063	2315	2567
Zone 2	1193	1249	1317	1447	1529	1637	1678	1853	1958	2094	2350	2606
Zone 3	1210	1268	1337	1469	1551	1661	1703	1881	1987	2125	2384	2644

- Oversized seat and back
- Pillow cushion comfort
- Wood arms/legs
- Seat: 19.5"W x 18.75"D x 18.5"H

QS NOW

FINISH SELECTION

ASPEN **AP** | BLACK **BLK** | BOARDWALK **BW** | ESPRESSO **ESP** | HONEY CHERRY **HCY** |
 MAHOGANY **MAH** | MOAB **MOB** | NATURAL **FM** | ROUGE MAHOGANY **RM** |
 WINDSOR CHERRY **WC** | SHORELINE **SL** | DRIFTWOOD **DW** |

SIN 711-18 3900 SERIES

CONTEMPORARY OFFICE

3907 Management Swivel

25.25" W X 30" D X 37.5-41.5" H St. Yardage: 4.25



Freight Class: 250
 Cubic Ft: 21
 Ship Weight: 54

Grade	1	2	3	4	5	6	7	8	9	10	L	LL
Zone 1	1275	1388	1509	1561	1607	1712	1753	1924	2030	2164	2643	2911
Zone 2	1294	1409	1532	1584	1631	1738	1779	1953	2060	2196	2683	2955
Zone 3	1313	1430	1554	1608	1655	1763	1806	1982	2091	2229	2722	2998

- Oversized seat and back
- Wood arms with upholstered accent
- 5-prong steel base with hardwood caps
- Standard swivel tilt
- Weight capacity 250 lbs
- See series overview above
- Seat: 21"W x 20.5"D x 18.25-22.25"H

OPTION	PRICE	CODE
Jury Base	315.00	JB
Knee Tilt Control	100.00	K
Edge Guard	16.00	E
CASTER	PRICE	CODE
Self-Locking Casters	85.00	S
Braking Casters	30.00	B
Hard-Floor Casters	19.00	H
Glides	N/C	GL

QS NOW

3921 Executive Swivel

25.25" W X 30" D X 44-48" H St. Yardage: 4.5



Freight Class: 250
 Cubic Ft: 23
 Ship Weight: 52

Grade	1	2	3	4	5	6	7	8	9	10	L	LL
Zone 1	1307	1437	1564	1658	1715	1771	1812	1994	2107	2247	2514	3046
Zone 2	1327	1459	1587	1683	1741	1798	1839	2024	2139	2281	2552	3092
Zone 3	1346	1480	1611	1708	1766	1824	1866	2054	2170	2314	2589	3137

- Black urethane arms
- Black 5-prong nylon reinforced base
- Oversized seat and back
- Standard swivel tilt
- Weight capacity 250 lbs
- Seat: 21"W x 20.5"D x 18.25-22.25"H

OPTION	PRICE	CODE
Knee Tilt Control	100.00	K
Edge Guard	16.00	E
CASTER	PRICE	CODE
Self-Locking Casters	85.00	S
Braking Casters	30.00	B
Hard-Floor Casters	19.00	H
Glides	N/C	GL

QS NOW

3927 Management Swivel

25.25" W X 30" D X 37.5-41.5" H St. Yardage: 4.25



Freight Class: 250
 Cubic Ft: 19
 Ship Weight: 50

Grade	1	2	3	4	5	6	7	8	9	10	L	LL
Zone 1	1251	1388	1509	1583	1635	1688	1728	1900	2006	2139	2733	2911
Zone 2	1270	1409	1532	1607	1660	1713	1754	1929	2036	2171	2774	2955
Zone 3	1289	1430	1554	1630	1684	1739	1780	1957	2066	2203	2815	2998

- Black urethane arms
- Black 5-prong nylon reinforced base
- Dual wheel casters
- Oversized seat and back
- Pillow cushion comfort
- Weight capacity 250 lbs
- Standard swivel tilt
- Seat: 21"W x 20.5"D x 18.25-22.25"H

OPTION	PRICE	CODE
Jury Base	315.00	JB
Knee Tilt Control	100.00	K
Edge Guard	16.00	E
CASTER	PRICE	CODE
Self-Locking Casters	85.00	S
Braking Casters	30.00	B
Hard-Floor Casters	19.00	H
Glides	N/C	GL

QS NOW

Traditional Style, Modern Value

Traditional Seating Series features period influences to create Wing Back, Goose Neck and other classic styles. Traditional tufting, individually-placed brass nail trim and shaped wood basecaps enhance the design.

Chair Details

- Brass nail trim
- Traditional tufting is standard on most models
- Black, dual-wheel carpet casters

Additional Options

- Knee tilt control option
- Edge Guard option
- Non-Tufted option
- No Brass Trim option



4075 Arm Chair



4053 Goose Neck Arm Chair



4074 Wing Back Arm Chair

Traditional Series

4013 Captain's Arm Chair

27" W X 25" D X 30" H

St. Yardage: 2



Freight Class: 250

Cubic Ft: 14

Ship Weight: 30

Grade	1	2	3	4	5	6	7	8	9	10	L	LL
Zone 1	932	996	1054	1089	1139	1181	1237	1289	1350	1469	1715	1865
Zone 2	946	1011	1070	1105	1156	1199	1256	1308	1370	1491	1741	1893
Zone 3	960	1026	1086	1122	1173	1216	1274	1328	1391	1513	1766	1921

OPTION	PRICE	CODE
• Brass nail head trim on back, arms and seat		
• Padded platform arms		
• Seat: 22"W x 20.5"D x 19"H		
No Brass Trim Option	N/C	NB

QS NOW

4016 Conference Chair

27" W X 25" D X 29.5" H

St. Yardage: 2



Freight Class: 250

Cubic Ft: 14

Ship Weight: 30

Grade	1	2	3	4	5	6	7	8	9	10	L	LL
Zone 1	1021	1083	1142	1176	1225	1246	1326	1376	1439	1557	1799	1952
Zone 2	1036	1099	1159	1194	1243	1265	1346	1397	1461	1580	1826	1981
Zone 3	1052	1115	1176	1211	1262	1283	1366	1417	1482	1604	1853	2011

OPTION	PRICE	CODE
• Brass nail head trim on back, arms and seat		
• Padded platform arms		
• Casters for mobility		
• Seat: 22"W x 20.5"D x 19"H		
No Brass Trim Option	N/C	NB
Hard-Floor Casters	19.00	H

QS NOW

4017 Management Swivel

27" W X 25" D X 32-36" H

St. Yardage: 2



Freight Class: 250

Cubic Ft: 19

Ship Weight: 52

Grade	1	2	3	4	5	6	7	8	9	10	L	LL
Zone 1	1226	1297	1355	1383	1431	1451	1532	1583	1645	1763	2009	2157
Zone 2	1244	1316	1375	1404	1452	1473	1555	1607	1670	1789	2039	2189
Zone 3	1263	1336	1396	1424	1474	1495	1578	1630	1694	1816	2069	2222

OPTION	PRICE	CODE
• Brass nail head trim on back, arms and seat		
• Padded platform arms		
• 5-prong steel base with hardwood caps		
• Pneumatic seat-height adjustment		
• Standard swivel tilt		
• Seat: 22"W x 20.5"D x 21.5-25.5"H		
Jury Base	315.00	JB
Knee Tilt Control	100.00	K
No Brass Trim Option	N/C	NB
CASTER OPTION	PRICE	CODE
Self-Locking Casters	85.00	S
Braking Casters	30.00	B
Hard-Floor Casters	19.00	H
Glides	N/C	GL

QS NOW

FINISH SELECTION

ASPEN **AP** | BLACK **BLK** | BOARDWALK **BW** | DRIFTWOOD **DW** |
 ESPRESSO **ESP** | HONEY CHERRY **HCY** | MAHOGANY **MAH** | MOAB **MOB** |
 ROUGE MAHOGANY **RM** | SHORELINE **SL** | WINDSOR CHERRY **WC** |

SIN 711-18 **TRADITIONAL**

TRADITIONAL OFFICE

2013 Arm Chair



25" W X 23" D X 30.5" H

St. Yardage: 2

Grade	1	2	3	4	5	6	7	8	9	10	L	LL
Zone 1	690	753	808	846	894	915	996	1045	1107	1225	1451	1621
Zone 2	700	764	820	859	907	929	1011	1061	1124	1243	1473	1645
Zone 3	711	776	832	871	921	942	1026	1076	1140	1262	1495	1670

Freight Class: 250
 Cubic Ft: 11
 Ship Weight: 31

- Thickly padded foam seat
- Brass nail head trim on arms and seat
- Padded platform arms
- Seat: 20"W x 19"D x 19"H

OPTION	PRICE	CODE
No Brass Trim Option	N/C	NB

QS NOW

2016 Conference Chair



25.5" W X 23" D X 30.5" H

St. Yardage: 2

Grade	1	2	3	4	5	6	7	8	9	10	L	LL
Zone 1	757	825	882	913	962	981	1062	1112	1174	1292	1538	1688
Zone 2	768	837	895	927	976	996	1078	1129	1192	1311	1561	1713
Zone 3	780	850	908	940	991	1010	1094	1145	1209	1331	1584	1739

Freight Class: 250
 Cubic Ft: 11
 Ship Weight: 27

- Thickly padded foam seat
- Brass nail head trim on arms and seat
- Padded platform arms
- 4 dual wheel carpet casters
- Seat: 20"W x 19"D x 18.5"H

OPTION	PRICE	CODE
No Brass Trim Option	N/C	NB

QS NOW

2177 Executive Swivel



27" W X 28.5" D X 40-43" H

St. Yardage: 3.5

Grade	1	2	3	4	5	6	7	8	9	10	L	LL
Zone 1	1235	1350	1453	1508	1596	1630	1771	1859	1967	2175	2652	2781
Zone 2	1254	1370	1475	1531	1620	1654	1798	1887	1997	2208	2692	2823
Zone 3	1272	1391	1497	1553	1644	1679	1824	1915	2026	2240	2732	2864

Freight Class: 250
 Cubic Ft: 23
 Ship Weight: 64

- Thickly padded foam seat
- Brass nail head trim on seat
- 5-prong steel base with hardwood caps
- Standard swivel tilt
- Pneumatic seat height adjustment
- Dual wheel casters
- Seat: 18.25"W x 19"D x 20-23"H

OPTION	PRICE	CODE
Knee Tilt Control	100.00	K
No Brass Trim Option	N/C	NB
Edge Guard	16.00	E
CASTER OPTION	PRICE	CODE
Self-Locking Casters	85.00	S
Braking Casters	30.00	B
Hard-Floor Casters	19.00	H
Glides	N/C	GL

QS NOW

2277 Executive Swivel

27" W X 28.5" D X 40-43" H

St. Yardage: 3.5



Freight Class: 250

Cubic Ft: 23

Ship Weight: 64

Grade	1	2	3	4	5	6	7	8	9	10	L	LL
Zone 1	1342	1456	1562	1616	1704	1736	1876	1964	2073	2282	2764	3002
Zone 2	1362	1478	1585	1640	1730	1762	1904	1993	2104	2316	2805	3047
Zone 3	1382	1500	1609	1664	1755	1788	1932	2023	2135	2350	2847	3092

- Thickly padded foam seat
- Tufted back
- Brass nail head trim on seat
- 5-prong steel base with hardwood caps
- Standard swivel tilt
- Pneumatic seat height adjustment
- Dual wheel casters
- Seat: 18.25"W x 19"D x 20-23"H

OPTION	PRICE	CODE
Knee Tilt Control	100.00	K
No Brass Trim Option	N/C	NB
Non-Tufted Option	N/C	NT
Edge Guard	16.00	E
CASTER OPTION	PRICE	CODE
Self-Locking Casters	85.00	S
Braking Casters	30.00	B
Hard-Floor Casters	19.00	H
Glides	N/C	GL

QS NOW

3473 Martha Washington Chair

24" W X 27" D X 40" H

St. Yardage: 3

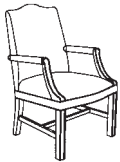

Freight Class: 250

Cubic Ft: 20

Ship Weight: 38

Grade	1	2	3	4	5	6	7	8	9	10	L	LL
Zone 1	1091	1194	1287	1343	1424	1456	1587	1667	1770	1961	2350	2533
Zone 2	1107	1212	1306	1363	1445	1478	1611	1692	1797	1990	2385	2571
Zone 3	1124	1230	1326	1383	1467	1500	1635	1717	1823	2020	2421	2609

- Thickly padded foam seat
- Upholstered arms
- Seat: 18.75"W x 18.75"D x 20"H

OPTION	PRICE	CODE
Tufted Seat for Chair	50.00	TS
Tufted Back for Chair	50.00	TB
Tufted Seat/Back for Chair	100.00	TSB

QS NOW

3477 Martha Washington Swivel

24" W X 27" D X 40-44" H

St. Yardage: 3



Freight Class: 150

Cubic Ft: 23

Ship Weight: 59

Grade	1	2	3	4	5	6	7	8	9	10	L	LL
Zone 1	1253	1361	1452	1506	1587	1619	1750	1831	1932	2125	2522	2695
Zone 2	1272	1381	1474	1529	1611	1643	1776	1858	1961	2157	2560	2735
Zone 3	1291	1402	1496	1551	1635	1668	1803	1886	1990	2189	2598	2776

- Thickly padded foam seat
- 5-prong steel base with hardwood caps
- Standard swivel tilt
- Upholstered arms
- Pneumatic seat-height adjustment
- Dual wheel casters
- Seat: 18.75"W x 18.75"D x 19.75-23"H

OPTION	PRICE	CODE
Knee Tilt Control	100.00	K
Edge Guard	16.00	E
Tufted Seat for Chair	50.00	TS
Tufted Back for Chair	50.00	TB
Tufted Seat/Back for Chair	100.00	TSB
CASTER OPTION	PRICE	CODE
Self-Locking Casters	85.00	S
Braking Casters	30.00	B
Hard-Floor Casters	19.00	H
Glides	N/C	GL

QS NOW

FINISH SELECTION

ASPEN AP | BLACK BLK | BOARDWALK BW | DRIFTWOOD DW |
 ESPRESSO ESP | HONEY CHERRY HCY | MAHOGANY MAH | MOAB MOB |
 ROUGE MAHOGANY RM | SHORELINE SL | WINDSOR CHERRY WC |

SIN 711-18 TRADITIONAL

TRADITIONAL OFFICE

4053 Goose Neck Arm Chair

25" W X 29" D X 43" H

St. Yardage: 3.5

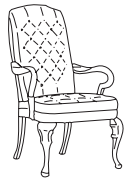

Freight Class: 250
 Cubic Ft: 24
 Ship Weight: 48

Grade	1	2	3	4	5	6	7	8	9	10	L	LL
Zone 1	1823	1933	2037	2095	2182	2216	2358	2445	2553	2760	3190	3367
Zone 2	1850	1962	2068	2126	2215	2249	2393	2482	2591	2801	3238	3418
Zone 3	1878	1991	2098	2158	2247	2282	2429	2518	2630	2843	3286	3468

- Tufted seat and back
- Goose neck arms
- Queen Anne style legs
- Seat: 18"W x 17.75"D x 19.5"H
- Brass nail head trim

OPTION	PRICE	CODE
Non-Tufted Option	N/C	NT
Upholstered Arm Caps	114.00	UA

QS NOW

4054 Armless Side Chair

25" W X 29" D X 43" H

St. Yardage: 3.5



Freight Class: 250
 Cubic Ft: 24
 Ship Weight: 45

Grade	1	2	3	4	5	6	7	8	9	10	L	LL
Zone 1	1307	1365	1429	1514	1580	1667	1701	1841	1928	2038	2129	2623
Zone 2	1327	1385	1450	1537	1604	1692	1727	1869	1957	2069	2161	2662
Zone 3	1346	1406	1472	1559	1627	1717	1752	1896	1986	2099	2193	2702

- Tufted seat and back
- Queen Anne style legs
- Seat: 18"W x 17.75"D x 19.5"H
- Brass nail head trim

OPTION	PRICE	CODE
Non-Tufted Option	N/C	NT

QS NOW

4057 Goose Neck Swivel

25" W X 29" D X 42-46" H

St. Yardage: 3.5



Freight Class: 250
 Cubic Ft: 24
 Ship Weight: 58

Grade	1	2	3	4	5	6	7	8	9	10	L	LL
Zone 1	1995	2107	2211	2268	2357	2389	2460	2531	2618	2726	3361	3655
Zone 2	2025	2139	2244	2302	2392	2425	2497	2569	2657	2767	3411	3710
Zone 3	2055	2170	2277	2336	2428	2461	2534	2607	2697	2808	3462	3765

- Tufted seat and back
- Goose neck arms
- 5-prong steel base with hardwood caps
- Brass nail head trim
- Pneumatic seat-height adjustment
- Standard swivel tilt
- Seat: 18"W x 17.75"D x 19-23"H

OPTION	PRICE	CODE
Knee Tilt Control	100.00	K
Non-Tufted Option		NT
Edge Guard	16.00	E
Upholstered Arm Caps	114.00	UA

CASTER OPTION	PRICE	CODE
Self-Locking Casters	85.00	S
Braking Casters	30.00	B
Hard-Floor Casters	19.00	H
Glides	N/C	GL

QS NOW

4075 Arm Chair

28" W X 26" D X 32" H

St. Yardage: 3.5



Freight Class: 250
 Cubic Ft: 14
 Ship Weight: 46

Grade	1	2	3	4	5	6	7	8	9	10	L	LL
Zone 1	1373	1498	1594	1647	1690	1734	1767	1909	1995	2105	2672	2918
Zone 2	1394	1520	1618	1672	1715	1760	1794	1938	2025	2137	2712	2962
Zone 3	1414	1543	1642	1696	1741	1786	1820	1966	2055	2168	2752	3006

- Tufted seat and back
- Brass nail head trim on arms and seat
- Chippendale style legs
- Cross rails for additional leg support
- Seat: 17"W x 18"D x 19.5"H

OPTION	PRICE	CODE
No Brass Trim Option	N/C	NB
Non-Tufted Option	N/C	NT

QS NOW

4076 Conference Chair with Casters

28" W X 26" D X 32" H

St. Yardage: 3.5



Freight Class: 250
 Cubic Ft: 14
 Ship Weight: 45

SIN #711-18

Grade	1	2	3	4	5	6	7	8	9	10	L	LL
Zone 1	1411	1525	1630	1683	1771	1804	1946	2032	2141	2348	2796	3069
Zone 2	1432	1548	1654	1708	1798	1831	1975	2062	2173	2383	2838	3115
Zone 3	1453	1571	1679	1733	1824	1858	2004	2093	2205	2418	2880	3161

- Tufted seat and back
- Brass nail head trim on arms and seat
- Chippendale style base
- Dual wheel casters
- Available in the finishes listed
- Seat: 17"W x 18"D x 19.5"H

OPTION	PRICE	CODE
No Brass Trim Option	N/C	NB
Non-Tufted Option	N/C	NT

QS NOW

4072 Loveseat

57" W X 27.5" D X 34" H

St. Yardage: 6



Freight Class: 250
 Cubic Ft: 36
 Ship Weight: 78

SIN #711-16

Grade	1	2	3	4	5	6	7	8	9	10	L	LL
Zone 1	2015	2243	2435	2541	2710	2776	3047	3215	3426	3824	4646	4887
Zone 2	2045	2277	2472	2579	2751	2818	3093	3263	3477	3881	4716	4960
Zone 3	2075	2310	2508	2617	2791	2859	3138	3311	3529	3939	4785	5034

- Tufted seat, back and inside arm
- Brass nail head trim on arms and seat
- Chippendale style legs
- Traditional scroll arm and camelback
- Cross rail adds leg support
- Seat: 47.5"W x 17.5"D x 19"H

OPTION	PRICE	CODE
No Brass Trim Option	N/C	NB
Non-Tufted Option	N/C	NT

QS NOW

4083 Sofa

78" W X 28" D X 35" H

St. Yardage: 8



Freight Class: 250
 Cubic Ft: 56
 Ship Weight: 113

SIN #711-16

Grade	1	2	3	4	5	6	7	8	9	10	L	LL
Zone 1	2493	2778	3020	3156	3368	3451	3792	4005	4270	4772	5702	5966
Zone 2	2530	2820	3065	3203	3419	3503	3849	4065	4334	4844	5788	6055
Zone 3	2568	2861	3111	3251	3469	3555	3906	4125	4398	4915	5873	6145

- Tufted seat, back and inside arm
- Brass nail head trim on arms and seat
- Chippendale style legs
- Traditional scroll arm and camelback
- Cross rail adds leg support
- Seat: 66"W x 18"D x 19"H

OPTION	PRICE	CODE
No Brass Trim Option	N/C	NB
Non-Tufted Option	N/C	NT

QS NOW

TR_4020 Traditional Cocktail Table

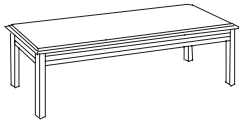

- High-gloss, high pressure laminate top in Mahogany and Windsor Cherry
- Shaped edges
- Ships unassembled, easy assembly

Freight Class: 100

SIN #711-11

	Zone Pricing		
	1	2	3
54" X 24" X 16" Cubic Ft: 5.5 Ship Weight: 69.5	833	845	858
Finish Options: Mahogany (M), Windsor Cherry (WC)			

QS NOW

TR_4023 Traditional End Table

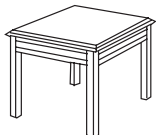

- High-gloss, high pressure laminate top in Mahogany and Windsor Cherry
- Shaped edges
- Ships unassembled, easy assembly

Freight Class: 92.5

SIN #711-11

	Zone Pricing		
	1	2	3
22" X 27" X 18" Cubic Ft: 2.5 Ship Weight: 38	689	699	710
Finish Options: Mahogany (M), Windsor Cherry (WC)			

QS NOW

FINISH SELECTION

ASPEN **AP** | BLACK **BLK** | BOARDWALK **BW** | DRIFTWOOD **DW** |
 ESPRESSO **ESP** | HONEY CHERRY **HCY** | MAHOGANY **MAH** | MOAB **MOB** |
 ROUGE MAHOGANY **RM** | SHORELINE **SL** | WINDSOR CHERRY **WC** |

SIN 711-18 **TRADITIONAL**

TRADITIONAL OFFICE

4073 Wing Back Arm Chair

27" W X 29" D X 39" H

St. Yardage: 4



Freight Class: 250
 Cubic Ft: 21
 Ship Weight: 50

Grade	1	2	3	4	5	6	7	8	9	10	L	LL
Zone 1	1425	1571	1705	1766	1873	2017	2072	2304	2448	2627	2875	3545
Zone 2	1446	1595	1731	1792	1901	2047	2103	2339	2485	2666	2918	3598
Zone 3	1468	1618	1756	1819	1929	2078	2134	2373	2521	2706	2961	3651

- Tufted seat and back
- Brass nail head trim on arms and seat
- Queen Anne style legs on front
- Weight capacity 350 lbs
- Seat: 19.5"F-16"B W x 18.25"D x 18.5"H

OPTION	PRICE	CODE
No Brass Trim Option	N/C	NB
Non-Tufted Option	N/C	NT

QS NOW

4074 Wing Back Arm Chair

29" W X 31" D X 40.5" H

St. Yardage: 4.5



Freight Class: 250
 Cubic Ft: 26
 Ship Weight: 51

Grade	1	2	3	4	5	6	7	8	9	10	L	LL
Zone 1	1509	1620	1735	1911	2037	2193	2269	2541	2711	2920	3052	3809
Zone 2	1532	1644	1761	1940	2068	2226	2303	2579	2752	2964	3098	3866
Zone 3	1554	1669	1787	1968	2098	2259	2337	2617	2792	3008	3144	3923

- Queen Anne style legs on front
- Tufted seat and back
- Brass nail head trim on arms and seat
- Full-size seat and back
- Weight capacity 350 lbs
- Seat: 18"B-22.5"F W x 19"D x 18.5"H

OPTION	PRICE	CODE
No Brass Trim Option	N/C	NB
Non-Tufted Option	N/C	NT

QS NOW

4077 Wing Back Swivel

25" W X 29" D X 42-46" H

St. Yardage: 4



Freight Class: 150
 Cubic Ft: 26
 Ship Weight: 71

Grade	1	2	3	4	5	6	7	8	9	10	L	LL
Zone 1	1502	1649	1776	1854	1965	2009	2095	2190	2302	2443	3257	3455
Zone 2	1525	1674	1803	1882	1994	2039	2126	2223	2337	2480	3306	3507
Zone 3	1547	1698	1829	1910	2024	2069	2158	2256	2371	2516	3355	3559

- Tufted seat and back
- Brass nail head trim on arms and seat
- 5-prong steel base with hardwood caps
- Standard swivel tilt
- Pneumatic seat-height adjustment
- Dual wheel casters
- Weight capacity 350 lbs
- Seat: 19.5"F-16"B W x 18.25"D x 18-21"H

OPTION	PRICE	CODE
Knee Tilt Control	100.00	K
No Brass Trim Option	N/C	NB
Non-Tufted Option	N/C	NT
Edge Guard	16.00	E
CASTER OPTION	PRICE	CODE
Self-Locking Casters	85.00	S
Braking Casters	30.00	B
Hard-Floor Casters	19.00	H
Glides	N/C	GL

QS NOW

4078 Wing Back Executive Swivel

29" W X 30" D X 41-45" H

St. Yardage: 4.5



Freight Class: 150
 Cubic Ft: 26
 Ship Weight: 77

Grade	1	2	3	4	5	6	7	8	9	10	L	LL
Zone 1	1814	2000	2167	2264	2407	2461	2694	2838	3017	3359	3820	4053
Zone 2	1841	2030	2200	2298	2443	2498	2734	2881	3062	3409	3877	4114
Zone 3	1868	2060	2232	2332	2479	2535	2775	2923	3108	3460	3935	4175

- Tufted seat and back
- Brass nail head trim on arms and seat
- 5-prong steel base with hardwood caps
- Standard swivel tilt
- Pneumatic seat-height adjustment
- Black dual-wheel carpet casters
- Weight capacity 350 lbs
- Seat: 18"B-22.5"F W x 19"D x 19-22.5"H

OPTION	PRICE	CODE
Knee Tilt Control	100.00	K
No Brass Trim Option	N/C	NB
Non-Tufted Option	N/C	NT
Edge Guard	16.00	E
CASTER OPTION	PRICE	CODE
Self-Locking Casters	85.00	S
Braking Casters	30.00	B
Hard-Floor Casters	19.00	H
Glides	N/C	GL

QS NOW

4178 Judge's Executive Swivel

29" W X 32" D X 42-46" H

St. Yardage: 4.75



Grade	1	2	3	4	5	6	7	8	9	10	L	LL
Zone 1	1925	2120	2295	2374	2517	2572	2805	2948	3127	3468	3927	4270
Zone 2	1954	2152	2329	2410	2555	2611	2847	2992	3174	3520	3986	4334
Zone 3	1983	2184	2364	2445	2593	2649	2889	3036	3221	3572	4045	4398

Freight Class: 150
 Cubic Ft: 28
 Ship Weight: 79

- 5-prong steel base with hardwood caps
- Pneumatic seat-height adjustment
- Standard swivel tilt

- Brass nail trim on arms and seat
- Black dual-wheel carpet casters
- Weight capacity 350 lbs
- Seat: 18.5"B-23"F W x 19.75"D x 19-23"H

OPTION	PRICE	CODE
Knee Tilt Control	100.00	K
No Brass Trim Option	N/C	NB
Edge Guard	16.00	E
CASTER OPTION	PRICE	CODE
Self-Locking Casters	85.00	S
Braking Casters	30.00	B
Hard-Floor Casters	19.00	H
Glides	N/C	GL

QS NOW

4277 Extra-High Back Executive Swivel

28" W X 31" D X 48-52" H

St. Yardage: 4.5



Grade	1	2	3	4	5	6	7	8	9	10	L	LL
Zone 1	1851	2022	2174	2243	2366	2415	2615	2741	2897	3192	3435	3878
Zone 2	1879	2052	2207	2277	2401	2451	2654	2782	2940	3240	3487	3936
Zone 3	1907	2083	2239	2310	2437	2487	2693	2823	2984	3288	3538	3994

Freight Class: 250
 Cubic Ft: 27
 Ship Weight: 83

- Tufted seat and back
- Thickly padded foam seat
- Brass nail head trim on arms and seat
- 5-prong steel base with hardwood caps

- Pneumatic seat-height adjustment
- Black dual-wheel carpet casters
- Weight capacity 350 lbs
- Seat: 18"W x 18"D x 19.5-23.5"H

OPTION	PRICE	CODE
Knee Tilt Control	100.00	K
No Brass Trim Option	N/C	NB
Non-Tufted Option	N/C	NT
Edge Guard	16.00	E
CASTER OPTION	PRICE	CODE
Self-Locking Casters	85.00	S
Braking Casters	30.00	B
Hard-Floor Casters	19.00	H
Glides	N/C	GL

QS NOW

FINISH SELECTION

ASPEN AP | BLACK BLK | BOARDWALK BW | DRIFTWOOD DW |
 ESPRESSO ESP | HONEY CHERRY HCY | MAHOGANY MAH | MOAB MOB |
 ROUGE MAHOGANY RM | SHORELINE SL | WINDSOR CHERRY WC |

SIN 711-18 SCOOP TRADITIONAL

TRADITIONAL OFFICE

Period Influence, Timeless Appeal

Scoop Traditional Seating features period influences in a variety of swivel and guest seating. Traditional tufting, individually placed brass nail trim and shaped wood base caps enhance the design.

Scoop Traditional Details

- Pneumatic lifts on all swivel chairs
- Standard swivel tilt on all swivel chairs
- Brass nail trim
- 3 arm styles: open wood arms, platform arms with padded cap, and rolled style upholstered arm
- Dual-wheel casters

Additional Options

- Knee tilt control option
- Edge Guard option
- Non-Tufted seat and back option
- No Brass Trim option



Executive 4161



4121 Executive

4127 Management

Scoop Traditional

4121 Executive Swivel

24" W X 31" D X 38-41.5" H

St. Yardage: 3.5



Freight Class: 250

Cubic Ft: 20

Ship Weight: 58

Grade	1	2	3	4	5	6	7	8	9	10	L	LL
Zone 1	1242	1365	1469	1534	1627	1664	1813	1909	2025	2247	2712	2889
Zone 2	1261	1385	1491	1557	1651	1689	1840	1938	2055	2281	2753	2932
Zone 3	1279	1406	1513	1580	1676	1714	1867	1966	2086	2314	2793	2976

- Tufted seat and back
- Padded arms
- 5-prong steel base with hardwood caps
- Standard swivel tilt
- Pneumatic seat-height adjustment
- Dual wheel casters
- Seat: 19.75"W x 19"D x 18-21.5"H

OPTION	PRICE	CODE
Knee Tilt Control	100.00	K
Non-Tufted Option	N/C	NT
Edge Guard	16.00	E

CASTER OPTION	PRICE	CODE
Self-Locking Casters	85.00	S
Braking Casters	30.00	B
Hard-Floor Casters	19.00	H
Glides	N/C	GL

QS NOW

4122 Arm Chair

23" W X 27" D X 33" H

St. Yardage: 3.25



Freight Class: 250

Cubic Ft: 15

Ship Weight: 30

Grade	1	2	3	4	5	6	7	8	9	10	L	LL
Zone 1	814	932	1045	1106	1199	1235	1386	1480	1597	1818	2274	2459
Zone 2	826	946	1061	1123	1217	1254	1407	1502	1621	1845	2308	2496
Zone 3	838	960	1076	1139	1235	1272	1428	1524	1645	1873	2342	2533

- Wood arms
- Tufted seat and back
- Built-in lumbar support
- Seat: 19.75"W x 19"D x 19.25"H

OPTION	PRICE	CODE
Non-Tufted Option	N/C	NT

QS NOW

FINISH SELECTION

ASPEN **AP** | BLACK **BLK** | BOARDWALK **BW** | DRIFTWOOD **DW** |
 ESPRESSO **ESP** | HONEY CHERRY **HCY** | MAHOGANY **MAH** | MOAB **MOB** |
 ROUGE MAHOGANY **RM** | SHORELINE **SL** | WINDSOR CHERRY **WC** |

4123 Arm Chair

24" W X 27" D X 33" H

St. Yardage: 3.25



Freight Class: 250
 Cubic Ft: 15
 Ship Weight: 30

Grade	1	2	3	4	5	6	7	8	9	10	L	LL
Zone 1	848	974	1081	1141	1233	1271	1420	1514	1632	1854	2307	2609
Zone 2	861	989	1097	1158	1251	1290	1441	1537	1656	1882	2342	2648
Zone 3	873	1003	1113	1175	1270	1309	1463	1559	1681	1910	2376	2687

	OPTION	PRICE	CODE
• Padded arms			
• Tufted seat and back	Non-Tufted Option	N/C	NT
• Built-in lumbar support			
• Seat: 19.75"W x 19"D x 19.25"H			

QS NOW

4127 Management Swivel

24" W X 27.5" D X 32-35" H

St. Yardage: 3.25



Freight Class: 250
 Cubic Ft: 19
 Ship Weight: 48

Grade	1	2	3	4	5	6	7	8	9	10	L	LL
Zone 1	1162	1283	1391	1455	1548	1585	1735	1830	1947	2168	2627	2809
Zone 2	1179	1302	1412	1477	1571	1609	1761	1857	1976	2201	2666	2851
Zone 3	1197	1321	1433	1499	1594	1633	1787	1885	2005	2233	2706	2893

	OPTION	PRICE	CODE
• Tufted seat and back			
• Padded arms			
• 5-prong steel base with hardwood caps			
• Standard swivel tilt			
• Pneumatic seat-height adjustment	Knee Tilt Control	100.00	K
• Dual wheel casters	Jury Base	315.00	JB
• Seat: 19.75"W x 19"D x 18-21.5"H	Non-Tufted Option	N/C	NT
	Edge Guard	16.00	E
	CASTER OPTION	PRICE	CODE
	Self-Locking Casters	85.00	S
	Braking Casters	30.00	B
	Hard-Floor Casters	19.00	H
	Glides	N/C	GL

QS NOW

4141 Executive Swivel

27" W X 31" D X 38.5-42" H

St. Yardage: 4.25



Freight Class: 150
 Cubic Ft: 21
 Ship Weight: 62

Grade	1	2	3	4	5	6	7	8	9	10	L	LL
Zone 1	1388	1562	1708	1779	1902	1951	2052	2152	2277	2432	2958	3426
Zone 2	1409	1585	1734	1806	1931	1980	2083	2184	2311	2468	3002	3477
Zone 3	1430	1609	1759	1832	1959	2010	2114	2217	2345	2505	3047	3529

	OPTION	PRICE	CODE
• Tufted seat and back			
• Fully upholstered, flared arms			
• 5-prong steel base with hardwood caps			
• Standard swivel tilt			
• Pneumatic seat-height adjustment	Knee Tilt Control	100.00	K
• Dual wheel casters	Non-Tufted Option	N/C	NT
• Seat: 19.5"W x 19"D x 18-21.5"H	Edge Guard	16.00	E
	CASTER OPTION	PRICE	CODE
	Self-Locking Casters	85.00	S
	Braking Casters	30.00	B
	Hard-Floor Casters	19.00	H
	Glides	N/C	GL

QS NOW

FINISH SELECTION

ASPEN **AP** | BLACK **BLK** | BOARDWALK **BW** | DRIFTWOOD **DW** |
 ESPRESSO **ESP** | HONEY CHERRY **HCY** | MAHOGANY **MAH** | MOAB **MOB** |
 ROUGE MAHOGANY **RM** | SHORELINE **SL** | WINDSOR CHERRY **WC** |

SIN 711-18 SCOOP TRADITIONAL

TRADITIONAL OFFICE

4147 Management Swivel

26" W X 27.5" D X 32-35" H

St. Yardage: 4



Grade	1	2	3	4	5	6	7	8	9	10	L	LL
Zone 1	1258	1428	1579	1648	1772	1820	1927	2034	2165	2327	2844	3306
Zone 2	1277	1449	1603	1673	1799	1847	1956	2065	2197	2362	2887	3356
Zone 3	1296	1471	1626	1697	1825	1875	1985	2095	2230	2397	2929	3405

- Tufted seat and back
- Fully upholstered, flared arms
- 5-prong steel base with hardwood caps
- Standard swivel tilt
- Pneumatic seat-height adjustment
- Dual wheel casters
- Seat: 19 5 "W x 19"D x 18-21.5"H

OPTION	PRICE	CODE
Knee Tilt Control	100.00	K
Jury Base	315.00	JB
Non-Tufted Option	N/C	NT
Edge Guard	16.00	E

CASTER OPTION	PRICE	CODE
Self-Locking Casters	85.00	S
Braking Casters	30.00	B
Hard-Floor Casters	19.00	H
Glides	N/C	GL

Freight Class: 150

Cubic Ft: 19

Ship Weight: 50

QS NOW

4161 Executive Swivel

25.5" W X 31" D X 38.5-42" H

St. Yardage: 3.5



Grade	1	2	3	4	5	6	7	8	9	10	L	LL
Zone 1	1250	1376	1478	1541	1635	1673	1823	1917	2033	2255	2720	2897
Zone 2	1269	1397	1500	1564	1660	1698	1850	1946	2063	2289	2761	2940
Zone 3	1288	1417	1522	1587	1684	1723	1878	1975	2094	2323	2802	2984

- Tufted seat and back
- Padded platform arms
- 5-prong steel base with hardwood caps
- Standard swivel tilt
- Pneumatic seat-height adjustment
- Dual wheel casters
- Seat: 19 5 "W x 19"D x 18-21.5"H

OPTION	PRICE	CODE
Knee Tilt Control	100.00	K
No Brass Trim Option	N/C	NB
Non-Tufted Option	N/C	NT
Edge Guard	16.00	E

CASTER OPTION	PRICE	CODE
Self-Locking Casters	85.00	S
Braking Casters	30.00	B
Hard-Floor Casters	19.00	H
Glides	N/C	GL

Freight Class: 250

Cubic Ft: 20

Ship Weight: 58

QS NOW

4167 Management Swivel

25.5" W X 27.5" D X 32-35" H

St. Yardage: 3.25



Grade	1	2	3	4	5	6	7	8	9	10	L	LL
Zone 1	1187	1308	1415	1479	1571	1609	1758	1854	1971	2192	2654	2834
Zone 2	1205	1328	1436	1501	1595	1633	1784	1882	2001	2225	2694	2877
Zone 3	1223	1347	1457	1523	1618	1657	1811	1910	2030	2258	2734	2919

- Tufted seat and back
- Padded platform arms
- 5-prong steel base with hardwood caps
- Standard swivel tilt
- Pneumatic seat-height adjustment
- Dual wheel casters
- Seat: 19 5 "W x 19"D x 18-21.5"H

OPTION	PRICE	CODE
Knee Tilt Control	100.00	K
Jury Base	315.00	JB
No Brass Trim Option	N/C	NB
Non-Tufted Option	N/C	NT
Edge Guard	16.00	E

CASTER OPTION	PRICE	CODE
Self-Locking Casters	85.00	S
Braking Casters	30.00	B
Hard-Floor Casters	19.00	H
Glides	N/C	GL

Freight Class: 150

Cubic Ft: 19

Ship Weight: 48

QS NOW

Quick Silver Traditional

4831 Executive Swivel

25" W X 28" D X 40-44" H

St. Yardage: 3



Freight Class: 250

Cubic Ft: 23

Ship Weight: 55

QS NOW

Grade	1	2	3	4	5	6	7	8	9	10	L	LL
Zone 1	1228	1336	1430	1481	1562	1594	1724	1805	1906	2100	2540	2785
Zone 2	1246	1356	1451	1503	1585	1618	1750	1832	1935	2132	2578	2827
Zone 3	1265	1376	1473	1525	1609	1642	1776	1859	1963	2163	2616	2869

- Brass nail head trim on arms
- 5-prong steel base with hardwood caps
- Standard swivel tilt, tufted back
- Pneumatic seat-height adjustment
- Seat: 19.25"W x 18"D x 17.5 -21.5"H

OPTION	PRICE	CODE
Knee Tilt Control	100.00	K
No Brass Trim Option	N/C	NB
Non-Tufted Option	N/C	NT
Edge Guard	16.00	E
CASTER OPTION	PRICE	CODE
Self-Locking Casters	85.00	S
Braking Casters	30.00	B
Hard-Floor Casters	19.00	H
Glides	N/C	GL

4837 Management Swivel

25" W X 26" D X 32-36" H

St. Yardage: 2.5



Freight Class: 250

Cubic Ft: 19

Ship Weight: 51

QS NOW

Grade	1	2	3	4	5	6	7	8	9	10	L	LL
Zone 1	1176	1262	1334	1371	1432	1457	1559	1620	1697	1845	2183	2426
Zone 2	1194	1281	1354	1392	1453	1479	1582	1644	1722	1873	2216	2462
Zone 3	1211	1300	1374	1412	1475	1501	1606	1669	1748	1900	2248	2499

- Brass nail head trim on arms
- 5-prong steel base with hardwood caps
- Standard swivel tilt, tufted back
- Pneumatic seat-height adjustment
- Dual wheel casters
- Seat: 19.25"W x 18"D x 17.5 -21.5"H

OPTION	PRICE	CODE
Knee Tilt Control	100.00	K
Jury Base	315.00	JB
No Brass Trim Option	N/C	NB
Non-Tufted Option	N/C	NT
Edge Guard	16.00	E
CASTER OPTION	PRICE	CODE
Self-Locking Casters	85.00	S
Braking Casters	30.00	B
Hard-Floor Casters	19.00	H
Glides	N/C	GL

4833 Side Chair

24" W X 26" D X 33" H

St. Yardage: 2.5



Freight Class: 250

Cubic Ft: 15

Ship Weight: 29

QS NOW

Grade	1	2	3	4	5	6	7	8	9	10	L	LL
Zone 1	1076	1163	1234	1283	1334	1357	1458	1521	1598	1747	2091	2328
Zone 2	1092	1180	1253	1302	1354	1377	1480	1544	1622	1773	2122	2363
Zone 3	1108	1198	1271	1321	1374	1398	1502	1567	1646	1799	2154	2398

- Wood arms
- Tufted back
- Seat: 19.25"W x 18"D x 18.5"H

OPTION	PRICE	CODE
Non-Tufted Option	N/C	NT

SEATING GUEST/GANGING



Design Flexibility with Armless Seating

Contempo presents elegant wood guest seating with extensive design flexibility. Solid hardwood frames offer the unique characteristics of wood. Select from four precision cut, multiple-layer hardwood plywood back designs known as Hourglass, Fan, Ladder and Puzzle.

Contempo Features

- *Armless*
- *6 back designs: hourglass, fan, ladder, puzzle, upholstered and partial upholstered backs*
- *Suspended, improved-cushioning seats*
- *Multiple-density foam*



9500 Upholstered Back



9400 Hourglass Back

CONTEMPO ARMLESS

9400 Hourglass Back Chair

20" W X 22" D X 34" H

St. Yardage: 1

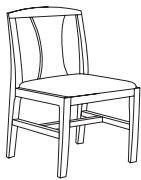

FREIGHT CLASS: 250
 CUBIC FT: 15
 SHIP WEIGHT: 31

Grade	1	2	3	4	5	6	7	8	9	10	L	LL
Zone 1	862	904	940	962	993	1006	1031	1057	1090	1129	1230	1359
Zone 2	875	918	954	976	1008	1021	1046	1073	1106	1146	1221	1379
Zone 3	888	931	968	991	1023	1036	1062	1089	1123	1163	1239	1400

- Solid hardwood frame
- Hourglass wood back
- Cross rails for added leg support
- Seat: 18.75"W x 18.75"D x 19"H

OPTION	PRICE	CODE
Casters for Guest Chairs	50.00	C

QS NOW

9410 Fan Back Chair

20" W X 22" D X 34" H

St. Yardage: 1



FREIGHT CLASS: 250
 CUBIC FT: 15
 SHIP WEIGHT: 31

Grade	1	2	3	4	5	6	7	8	9	10	L	LL
Zone 1	862	904	940	962	993	1006	1031	1057	1090	1129	1203	1359
Zone 2	875	918	954	976	1008	1021	1046	1073	1106	1146	1221	1379
Zone 3	888	931	968	991	1023	1036	1062	1089	1123	1163	1239	1400

- Solid hardwood frame
- Fan wood back
- Cross rails for added leg support
- Seat: 18.75"W x 18.75"D x 19"H

OPTION	PRICE	CODE
Casters for Guest Chairs	50.00	C

QS NOW

9420 Ladder Back Chair

20" W X 22" D X 34" H

St. Yardage: 1



FREIGHT CLASS: 250
 CUBIC FT: 15
 SHIP WEIGHT: 31

Grade	1	2	3	4	5	6	7	8	9	10	L	LL
Zone 1	862	904	940	962	993	1006	1031	1057	1090	1129	1203	1359
Zone 2	875	918	954	976	1008	1021	1046	1073	1106	1146	1221	1379
Zone 3	888	931	968	991	1023	1036	1062	1089	1123	1163	1239	1400

- Solid hardwood frame
- Ladder wood back
- Cross rails for added leg support
- Seat: 18.75"W x 18.75"D x 19"H

OPTION	PRICE	CODE
Casters for Guest Chairs	50.00	C

QS NOW

FINISH SELECTION

ASPEN **AP** | BLACK **BLK** | BOARDWALK **BW** | DRIFTWOOD **DW** | ESPRESSO **ESP** | HONEY CHERRY **HCY** | MAHOGANY **MAH** | MOAB **MOB** | NATURAL **FM** | ROUGE MAHOGANY **RM** | WINDSOR CHERRY **WC** | SHORELINE **SL** |

SIN 711-18 **CONTEMPO ARMLESS**

GUEST

9430 Puzzle Back Chair

20" W X 22" D X 34" H

St. Yardage: 1



FREIGHT CLASS: 250
CUBIC FT: 15
SHIP WEIGHT: 31

Grade	1	2	3	4	5	6	7	8	9	10	L	LL
Zone 1	862	904	940	962	993	1006	1031	1057	1090	1129	1203	1359
Zone 2	875	918	954	976	1008	1021	1046	1073	1106	1146	1221	1379
Zone 3	888	931	968	991	1023	1036	1062	1089	1123	1163	1239	1400

- Solid hardwood frame
- Puzzle wood back
- Cross rails for added leg support
- Seat: 18.75"W x 18.75"D x 19"H

OPTION	PRICE	CODE
Casters for Guest Chairs	50.00	C

QS NOW

9500 Upholstered Back Chair

20" W X 22" D X 34" H

St. Yardage: 1.5

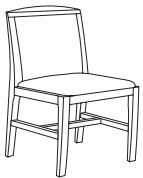

FREIGHT CLASS: 250
CUBIC FT: 15
SHIP WEIGHT: 31

Grade	1	2	3	4	5	6	7	8	9	10	L	LL
Zone 1	924	966	1003	1045	1083	1133	1153	1235	1287	1350	1424	1646
Zone 2	938	980	1018	1061	1099	1150	1170	1254	1306	1370	1445	1671
Zone 3	952	995	1033	1076	1115	1167	1188	1272	1326	1391	1467	1695

- Solid hardwood frame
- Upholstered back
- Cross rails for added leg support
- Seat: 18.75"W x 18.75"D x 19"H

OPTION	PRICE	CODE
Casters for Guest Chairs	50.00	C

QS NOW

9510 Partial Upholstered Back Chair

20" W X 22" D X 34" H

St. Yardage: 1.5



FREIGHT CLASS: 250
CUBIC FT: 15
SHIP WEIGHT: 33

Grade	1	2	3	4	5	6	7	8	9	10	L	LL
Zone 1	924	966	1003	1045	1083	1133	1153	1235	1287	1350	1424	1646
Zone 2	938	980	1018	1061	1099	1150	1170	1254	1306	1370	1445	1671
Zone 3	952	995	1033	1076	1115	1167	1188	1272	1326	1391	1467	1695

- Solid hardwood frame
- Partially upholstered back
- Cross rails for added leg support
- Seat: 18.75"W x 18.75"D x 19"H

OPTION	PRICE	CODE
Casters for Guest Chairs	50.00	C

QS NOW

94CTC Ganging Kit

- Chair-to-chair ganging
- Black powder coated 16 gauge steel
- One kit needed for each connection

10" W X 3.5" D X .125" H

Cubic Ft: 0.2

Ship Weight: 0.5

Zone Pricing	1	2	3
	32	32	33

QS NOW

FREIGHT CLASS: 70

Design Flexibility

Contempo presents elegant wood guest seating with extensive design flexibility. Solid hardwood frames offer the unique characteristics of wood. Choose from three arm styles. Select from four precision cut, multiple-layer hardwood plywood back designs known as Hourglass, Fan, Ladder and Puzzle.

Contempo Features

- 3 arm designs: *curvilinear, sloped, and scalloped*
- 6 back designs: *hourglass, fan, ladder, puzzle, upholstered and partial upholstered backs*
- *Suspended, improved-cushioning seats*
- *Multiple-density foam*

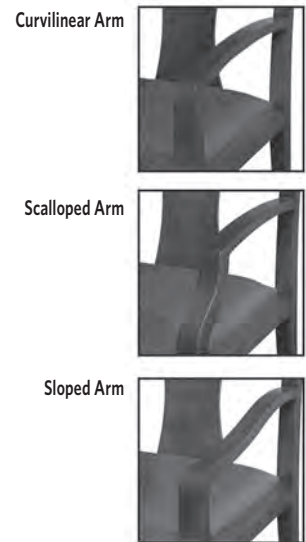

9433 Puzzle Back
with Curvilinear Arms

CONTEMPO ARM CHAIRS Hourglass Back

9403 Curvilinear Arms

22" W X 22.5" D X 34" H

St. Yardage: 1

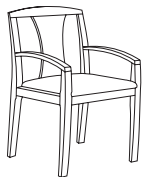

FREIGHT CLASS: 250
CUBIC FT: 15
SHIP WEIGHT: 32

Grade	1	2	3	4	5	6	7	8	9	10	L	LL
Zone 1	924	966	1003	1045	1083	1133	1153	1235	1287	1350	1424	1646
Zone 2	938	980	1018	1061	1099	1150	1170	1254	1306	1370	1445	1671
Zone 3	952	995	1033	1076	1115	1167	1188	1272	1326	1391	1467	1695

- Solid hardwood frame with reinforcing stretchers
- Flexible seat suspension

- Generous seat foam
- Seat: 18.75"W x 18.75"D x 19"H

OPTION	PRICE	CODE
Casters for Guest Chairs	50.00	C

QS NOW

9404 Sloped Arms

22" W X 22.5" D X 34" H

St. Yardage: 1

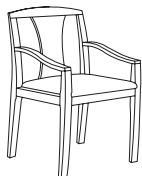

FREIGHT CLASS: 250
CUBIC FT: 15
SHIP WEIGHT: 32

Grade	1	2	3	4	5	6	7	8	9	10	L	LL
Zone 1	924	966	1003	1045	1083	1133	1153	1235	1287	1350	1424	1646
Zone 2	938	980	1018	1061	1099	1150	1170	1254	1306	1370	1445	1671
Zone 3	952	995	1033	1076	1115	1167	1188	1272	1326	1391	1467	1695

- Solid hardwood frame with reinforcing stretchers
- Flexible seat suspension

- Generous seat foam
- Seat: 18.75"W x 18.75"D x 19"H

OPTION	PRICE	CODE
Casters for Guest Chairs	50.00	C

QS NOW

9405 Scalloped Arms

22" W X 22.5" D X 34" H

St. Yardage: 1



FREIGHT CLASS: 250
CUBIC FT: 15
SHIP WEIGHT: 32

Grade	1	2	3	4	5	6	7	8	9	10	L	LL
Zone 1	924	966	1003	1045	1083	1133	1153	1235	1287	1350	1424	1646
Zone 2	938	980	1018	1061	1099	1150	1170	1254	1306	1370	1445	1671
Zone 3	952	995	1033	1076	1115	1167	1188	1272	1326	1391	1467	1695

- Solid hardwood frame with reinforcing stretchers
- Flexible seat suspension

- Generous seat foam
- Seat: 18.75"W x 18.75"D x 19"H

OPTION	PRICE	CODE
Casters for Guest Chairs	50.00	C

QS NOW

FINISH SELECTION

ASPEN **AP** | BLACK **BLK** | BOARDWALK **BW** | DRIFTWOOD **DW** | ESPRESSO **ESP** |
 HONEY CHERRY **HCY** | MAHOGANY **MAH** | MOAB **MOB** | NATURAL **FM** |
 ROUGE MAHOGANY **RM** | WINDSOR CHERRY **WC** | SHORELINE **SL** |

SIN 711-18 CONTEMPO ARM CHAIRS

GUEST

CONTEMPO ARM CHAIRS Fan Back

9413 Curvilinear Arms

22" W X 22.5" D X 34" H St. Yardage: 1



FREIGHT CLASS: 250
 CUBIC FT: 15
 SHIP WEIGHT: 32

QS NOW

Grade	1	2	3	4	5	6	7	8	9	10	L	LL
Zone 1	924	966	1003	1045	1083	1133	1153	1235	1287	1350	1424	1646
Zone 2	938	980	1018	1061	1099	1150	1170	1254	1306	1370	1445	1671
Zone 3	952	995	1033	1076	1115	1167	1188	1272	1326	1391	1467	1695

	OPTION	PRICE	CODE
• Solid hardwood frame with reinforcing stretchers	• Generous seat foam		
• Flexible seat suspension	• Seat: 18.75"W x 18.75"D x 19"H		
	Casters for Guest Chairs	50.00	C

9414 Sloped Arms

22" W X 22.5" D X 34" H St. Yardage: 1



FREIGHT CLASS: 250
 CUBIC FT: 15
 SHIP WEIGHT: 32

QS NOW

Grade	1	2	3	4	5	6	7	8	9	10	L	LL
Zone 1	924	966	1003	1045	1083	1133	1153	1235	1287	1350	1424	1646
Zone 2	938	980	1018	1061	1099	1150	1170	1254	1306	1370	1445	1671
Zone 3	952	995	1033	1076	1115	1167	1188	1272	1326	1391	1467	1695

	OPTION	PRICE	CODE
• Solid hardwood frame with reinforcing stretchers	• Generous seat foam		
• Flexible seat suspension	• Seat: 18.75"W x 18.75"D x 19"H		
	Casters for Guest Chairs	50.00	C

9415 Scalloped Arms

22" W X 22.5" D X 34" H St. Yardage: 1



FREIGHT CLASS: 250
 CUBIC FT: 15
 SHIP WEIGHT: 32

QS NOW

Grade	1	2	3	4	5	6	7	8	9	10	L	LL
Zone 1	924	966	1003	1045	1083	1133	1153	1235	1287	1350	1424	1646
Zone 2	938	980	1018	1061	1099	1150	1170	1254	1306	1370	1445	1671
Zone 3	952	995	1033	1076	1115	1167	1188	1272	1326	1391	1467	1695

	OPTION	PRICE	CODE
• Solid hardwood frame with reinforcing stretchers	• Generous seat foam		
• Flexible seat suspension	• Seat: 18.75"W x 18.75"D x 19"H		
	Casters for Guest Chairs	50.00	C

CONTEMPO ARM CHAIRS Ladder Back

9423 Curvilinear Arms

22" W X 22.5" D X 34" H St. Yardage: 1



FREIGHT CLASS: 250
 CUBIC FT: 15
 SHIP WEIGHT: 32

QS NOW

Grade	1	2	3	4	5	6	7	8	9	10	L	LL
Zone 1	924	966	1003	1045	1083	1133	1153	1235	1287	1350	1424	1646
Zone 2	938	980	1018	1061	1099	1150	1170	1254	1306	1370	1445	1671
Zone 3	952	995	1033	1076	1115	1167	1188	1272	1326	1391	1467	1695

	OPTION	PRICE	CODE
• Solid hardwood frame with reinforcing stretchers	• Generous seat foam		
• Flexible seat suspension	• Seat: 18.75"W x 18.75"D x 19"H		
	Casters for Guest Chairs	50.00	C

9424 Sloped Arms

22" W X 22.5" D X 34" H St. Yardage: 1



FREIGHT CLASS: 250
 CUBIC FT: 15
 SHIP WEIGHT: 32

QS NOW

Grade	1	2	3	4	5	6	7	8	9	10	L	LL
Zone 1	924	966	1003	1045	1083	1133	1153	1235	1287	1350	1424	1646
Zone 2	938	980	1018	1061	1099	1150	1170	1254	1306	1370	1445	1671
Zone 3	952	995	1033	1076	1115	1167	1188	1272	1326	1391	1467	1695

	OPTION	PRICE	CODE
• Solid hardwood frame with reinforcing stretchers	• Generous seat foam		
• Flexible seat suspension	• Seat: 18.75"W x 18.75"D x 19"H		
	Casters for Guest Chairs	50.00	C

9425 Scalloped Arms

22" W X 22.5" D X 34" H St. Yardage: 1



FREIGHT CLASS: 250
 CUBIC FT: 15
 SHIP WEIGHT: 32

QS NOW

Grade	1	2	3	4	5	6	7	8	9	10	L	LL
Zone 1	924	966	1003	1045	1083	1133	1153	1235	1287	1350	1424	1646
Zone 2	938	980	1018	1061	1099	1150	1170	1254	1306	1370	1445	1671
Zone 3	952	995	1033	1076	1115	1167	1188	1272	1326	1391	1467	1695

	OPTION	PRICE	CODE
• Solid hardwood frame with reinforcing stretchers	• Generous seat foam		
• Flexible seat suspension	• Seat: 18.75"W x 18.75"D x 19"H		
	Casters for Guest Chairs	50.00	C

CONTEMPO ARM CHAIRS Puzzle Back

9433 Curvilinear Arms

22" W X 22.5" D X 34" H

St. Yardage: 1



FREIGHT CLASS: 250
 CUBIC FT: 15
 SHIP WEIGHT: 32

Grade	1	2	3	4	5	6	7	8	9	10	L	LL
Zone 1	924	966	1003	1045	1083	1133	1153	1235	1287	1350	1424	1646
Zone 2	938	980	1018	1061	1099	1150	1170	1254	1306	1370	1445	1671
Zone 3	952	995	1033	1076	1115	1167	1188	1272	1326	1391	1467	1695

- Solid hardwood frame with reinforcing stretchers
- Flexible seat suspension
- Generous seat foam
- Seat: 18.75"W x 18.75"D x 19"H

OPTION	PRICE	CODE
Casters for Guest Chairs	50.00	C

QS NOW

9434 Sloped Arms

22" W X 22.5" D X 34" H

St. Yardage: 1



FREIGHT CLASS: 250
 CUBIC FT: 15
 SHIP WEIGHT: 32

Grade	1	2	3	4	5	6	7	8	9	10	L	LL
Zone 1	924	966	1003	1045	1083	1133	1153	1235	1287	1350	1424	1646
Zone 2	938	980	1018	1061	1099	1150	1170	1254	1306	1370	1445	1671
Zone 3	952	995	1033	1076	1115	1167	1188	1272	1326	1391	1467	1695

- Solid hardwood frame with reinforcing stretchers
- Flexible seat suspension
- Generous seat foam
- Seat: 18.75"W x 18.75"D x 19"H

OPTION	PRICE	CODE
Casters for Guest Chairs	50.00	C

QS NOW

9435 Scalloped Arms

22" W X 22.5" D X 34" H

St. Yardage: 1



FREIGHT CLASS: 250
 CUBIC FT: 15
 SHIP WEIGHT: 32

Grade	1	2	3	4	5	6	7	8	9	10	L	LL
Zone 1	924	966	1003	1045	1083	1133	1153	1235	1287	1350	1424	1646
Zone 2	938	980	1018	1061	1099	1150	1170	1254	1306	1370	1445	1671
Zone 3	952	995	1033	1076	1115	1167	1188	1272	1326	1391	1467	1695

- Solid hardwood frame with reinforcing stretchers
- Flexible seat suspension
- Generous seat foam
- Seat: 18.75"W x 18.75"D x 19"H

OPTION	PRICE	CODE
Casters for Guest Chairs	50.00	C

QS NOW

CONTEMPO ARM CHAIRS Fully Upholstered Back

9503 Curvilinear Arms

22" W X 22.5" D X 34" H

St. Yardage: 1.5

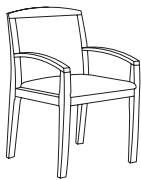

FREIGHT CLASS: 250
 CUBIC FT: 15
 SHIP WEIGHT: 37

Grade	1	2	3	4	5	6	7	8	9	10	L	LL
Zone 1	1003	1069	1127	1162	1213	1232	1273	1313	1365	1428	1549	1800
Zone 2	1018	1085	1144	1179	1231	1250	1292	1333	1385	1449	1572	1827
Zone 3	1033	1101	1161	1197	1249	1269	1311	1352	1406	1471	1595	1854

- Solid hardwood frame with reinforcing stretchers
- Flexible seat suspension
- Generous seat foam
- Seat: 18.75"W x 18.75"D x 19"H

OPTION	PRICE	CODE
Casters for Guest Chairs	50.00	C

QS NOW

9504 Sloped Arms

22" W X 22.5" D X 34" H

St. Yardage: 1.5



FREIGHT CLASS: 250
 CUBIC FT: 15
 SHIP WEIGHT: 32

Grade	1	2	3	4	5	6	7	8	9	10	L	LL
Zone 1	1003	1069	1127	1162	1213	1232	1273	1313	1365	1428	1549	1800
Zone 2	1018	1085	1144	1179	1231	1250	1292	1333	1385	1449	1572	1827
Zone 3	1033	1101	1161	1197	1249	1269	1311	1352	1406	1471	1595	1854

- Solid hardwood frame with reinforcing stretchers
- Flexible seat suspension
- Generous seat foam
- Seat: 18.75"W x 18.75"D x 19"H

OPTION	PRICE	CODE
Casters for Guest Chairs	50.00	C

QS NOW

FINISH SELECTION

ASPEN **AP** | BLACK **BLK** | BOARDWALK **BW** | DRIFTWOOD **DW** | ESPRESSO **ESP** |
 HONEY CHERRY **HCY** | MAHOGANY **MAH** | MOAB **MOB** | NATURAL **FM** |
 ROUGE MAHOGANY **RM** | WINDSOR CHERRY **WC** | SHORELINE **SL** |

SIN 711-18 CONTEMPO ARM CHAIRS

GUEST

9505 Scalloped Arms

22" W X 22.5" D X 34" H

St. Yardage: 1.5



FREIGHT CLASS: 250
 CUBIC FT: 15
 SHIP WEIGHT: 32

Grade	1	2	3	4	5	6	7	8	9	10	L	LL
Zone 1	1003	1069	1127	1162	1213	1232	1273	1313	1365	1428	1549	1800
Zone 2	1018	1085	1144	1179	1231	1250	1292	1333	1385	1449	1572	1827
Zone 3	1033	1101	1161	1197	1249	1269	1311	1352	1406	1471	1595	1854

- Solid hardwood frame with reinforcing stretchers
- Flexible seat suspension
- Generous seat foam
- Seat: 18.75"W x 18.75"D x 19"H

OPTION	PRICE	CODE
Casters for Guest Chairs	50.00	C

QS NOW

CONTEMPO ARM CHAIRS Partial Upholstered Back

9513 Curvilinear Arms

22" W X 22.5" D X 34" H

St. Yardage: 1.5



FREIGHT CLASS: 250
 CUBIC FT: 15
 SHIP WEIGHT: 37

Grade	1	2	3	4	5	6	7	8	9	10	L	LL
Zone 1	1003	1069	1127	1162	1213	1232	1273	1313	1365	1428	1549	1800
Zone 2	1018	1085	1144	1179	1231	1250	1292	1333	1385	1449	1572	1827
Zone 3	1033	1101	1161	1197	1249	1269	1311	1352	1406	1471	1595	1854

- Solid hardwood frame with reinforcing stretchers
- Flexible seat suspension
- Generous seat foam
- Seat: 18.75"W x 18.75"D x 19"H

OPTION	PRICE	CODE
Casters for Guest Chairs	50.00	C

QS NOW

9514 Sloped Arms

22" W X 22.5" D X 34" H

St. Yardage: 1.5



FREIGHT CLASS: 250
 CUBIC FT: 15
 SHIP WEIGHT: 32

Grade	1	2	3	4	5	6	7	8	9	10	L	LL
Zone 1	1003	1069	1127	1162	1213	1232	1273	1313	1365	1428	1549	1800
Zone 2	1018	1085	1144	1179	1231	1250	1292	1333	1385	1449	1572	1827
Zone 3	1033	1101	1161	1197	1249	1269	1311	1352	1406	1471	1595	1854

- Solid hardwood frame with reinforcing stretchers
- Flexible seat suspension
- Generous seat foam
- Seat: 18.75"W x 18.75"D x 19"H

OPTION	PRICE	CODE
Casters for Guest Chairs	50.00	C

QS NOW

9515 Scalloped Arms

22" W X 22.5" D X 34" H

St. Yardage: 1.5



FREIGHT CLASS: 250
 CUBIC FT: 15
 SHIP WEIGHT: 32

Grade	1	2	3	4	5	6	7	8	9	10	L	LL
Zone 1	1003	1069	1127	1162	1213	1232	1273	1313	1365	1428	1549	1800
Zone 2	1018	1085	1144	1179	1231	1250	1292	1333	1385	1449	1572	1827
Zone 3	1033	1101	1161	1197	1249	1269	1311	1352	1406	1471	1595	1854

- Solid hardwood frame with reinforcing stretchers
- Flexible seat suspension
- Generous seat foam
- Seat: 18.75"W x 18.75"D x 19"H

OPTION	PRICE	CODE
Casters for Guest Chairs	50.00	C

QS NOW

94CTC Ganging Kit

- Chair-to-chair ganging
- Black powder coated 16 gauge steel
- One kit needed for each connection

10" W X 3.5" D X .125" H

Cubic Ft: 0.2

Ship Weight: 0.5

Zone Pricing	1	2	3
	32	32	33

FREIGHT CLASS: 70

GUEST

Solid Comfort

The **Unos** collection is constructed with extremely sturdy frames in a transitional design. Steel cross braces provide solid construction with a weight capacity of 350 lb. per unit. Bariatric width chairs also include steel cross braces in the back and offer standard weight capacity of 500 lb. with a 750 lb. and 1,000 lb. option.



Unos Arm Chair 904

Design Details

- Extra wide arms with scalloped design
- Separated seats and backs for easy clean out
- Steel reinforced seat frame
- Backs have hook and loop fasteners for easy field replacements
- Seats are field replaceable
- Wall saver leg design
- Adjustable glides



Unos

904 Armchair

24.75" W X 25.5" D X 35" H St. Yardage: 2



FREIGHT CLASS: 250
 CUBIC FT: 15
 SHIP WEIGHT: 37

Grade	1	2	3	4	5	6	7	8	9	10	L	LL
Zone 1	968	1014	1068	1121	1170	1233	1298	1363	1427	1507	1646	2024
Zone 2	983	1029	1084	1138	1188	1251	1317	1383	1448	1530	1671	2054
Zone 3	997	1044	1100	1155	1205	1270	1337	1404	1470	1552	1695	2085

	OPTION	PRICE	CODE
<ul style="list-style-type: none"> • Extra sturdy solid hardwood frame • Transitional style 2" wide scalloped arms/legs 	<ul style="list-style-type: none"> • Separated upholstered seat and back for easy cleanout • Steel reinforced seat frame • Weight capacity of 350 lbs • Seat: 20"W x 19"D x 18"H 	Black Polyurethane Arm Caps	86.00 PC

QS NOW

906 Two-Seat Settee

50" W X 25.5" D X 35" H St. Yardage: 3.25

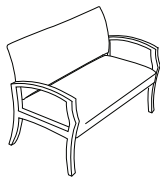

FREIGHT CLASS: 250
 CUBIC FT: 36
 SHIP WEIGHT: 88

Grade	1	2	3	4	5	6	7	8	9	10	L	LL
Zone 1	1497	1543	1604	1649	1695	1763	1824	1893	1954	2030	2213	2555
Zone 2	1519	1566	1628	1674	1720	1789	1851	1921	1983	2060	2246	2593
Zone 3	1542	1589	1652	1698	1746	1816	1879	1950	2013	2091	2279	2632

	OPTION	PRICE	CODE
<ul style="list-style-type: none"> • Extra sturdy solid hardwood frame • Transitional style 2" wide scalloped arms/legs 	<ul style="list-style-type: none"> • Separated upholstered seat and back for easy cleanout • Steel reinforced seat frame • Weight capacity of 350 lbs • Seat: 45"W x 19"D x 18"H 	Black Polyurethane Arm Caps	86.00 PC

QS NOW

908 Bench

50" W X 25.5" D X 25.5" H St. Yardage: 2

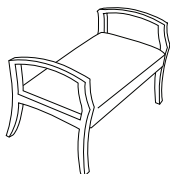

FREIGHT CLASS: 175
 CUBIC FT: 36
 SHIP WEIGHT: 69

Grade	1	2	3	4	5	6	7	8	9	10	L	LL
Zone 1	1094	1141	1194	1248	1296	1360	1424	1488	1555	1634	1772	2150
Zone 2	1110	1158	1212	1267	1315	1380	1445	1510	1578	1659	1799	2182
Zone 3	1127	1175	1230	1285	1335	1401	1467	1533	1602	1683	1825	2215

	OPTION	PRICE	CODE
<ul style="list-style-type: none"> • 48" bench with extra sturdy solid hardwood frame • Transitional style 2" wide scalloped arms/legs 	<ul style="list-style-type: none"> • Reinforced seat frame with steel cross braces • Weight capacity of 350 lbs • Seat: 45"W x 19"D x 18"H 	Black Polyurethane Arm Caps	86.00 PC

QS NOW

FINISH SELECTION

ASPEN **AP** | BLACK **BLK** | BOARDWALK **BW** | DRIFTWOOD **DW** | ESPRESSO **ESP** |
 HONEY CHERRY **HCY** | MAHOGANY **MAH** | MOAB **MOB** | NATURAL **FM** |
 ROUGE MAHOGANY **RM** | WINDSOR CHERRY **WC** | SHORELINE **SL** |

SIN 71-317 UNOS

GUEST

902 Bariatric Chair, 30" Wide Seat

35" W X 25.5" D X 35" H

St. Yardage: 2.5

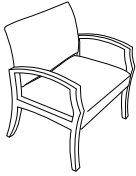

FREIGHT CLASS: 175
 CUBIC FT: 36
 SHIP WEIGHT: 70

Grade	1	2	3	4	5	6	7	8	9	10	L	LL
Zone 1	1398	1433	1480	1515	1550	1603	1650	1703	1749	1808	1949	2212
Zone 2	1419	1454	1502	1538	1573	1627	1675	1729	1775	1835	1978	2245
Zone 3	1440	1476	1524	1560	1597	1651	1700	1754	1801	1862	2007	2278

- Bariatric chair with 30" wide seat
- Extra sturdy solid hardwood frame
- Transitional style 2" wide scalloped arms/legs
- Separated upholstered seat and back for easy cleanout
- Reinforced seat and back frames with steel cross braces
- Weight capacity of 500 lbs
- Seat: 30"W x 19"D x 18"H

OPTION	PRICE	CODE
750 lb. Bariatric Rating	130.00	HB
1000 lb. Bariatric Rating	250.00	XB
Black Polyurethane Arm Caps	86.00	PC

QS NOW

903 Bariatric Chair, 40" Wide Seat

45" W X 25.5" D X 35" H

St. Yardage: 3



FREIGHT CLASS: 175
 CUBIC FT: 36
 SHIP WEIGHT: 86

Grade	1	2	3	4	5	6	7	8	9	10	L	LL
Zone 1	1543	1585	1641	1684	1726	1789	1845	1908	1965	2035	2204	2520
Zone 2	1566	1609	1666	1709	1752	1816	1873	1937	1994	2066	2237	2558
Zone 3	1589	1633	1690	1735	1778	1843	1900	1965	2024	2096	2270	2596

- Bariatric chair with 40" wide seat
- Extra sturdy solid hardwood frame
- Transitional style 2" wide scalloped arms/legs
- Separated upholstered seat and back for easy cleanout
- Reinforced seat and back frames with steel cross braces
- Weight capacity of 500 lbs
- Seat: 40"W x 19"D x 18"H

OPTION	PRICE	CODE
750 lb. Bariatric Rating	130.00	HB
1000 lb. Bariatric Rating	250.00	XB
Black Polyurethane Arm Caps	86.00	PC

QS NOW

905 High Back Patient's Chair

24.75" W X 25.5" D X 46" H

St. Yardage: 3



FREIGHT CLASS: 300
 CUBIC FT: 23
 SHIP WEIGHT: 46

Grade	1	2	3	4	5	6	7	8	9	10	L	LL
Zone 1	1045	1104	1172	1236	1298	1378	1458	1538	1620	1721	1894	2366
Zone 2	1061	1121	1190	1255	1317	1399	1480	1561	1644	1747	1922	2401
Zone 3	1076	1137	1207	1273	1337	1419	1502	1584	1669	1773	1951	2437

- Extra sturdy solid hardwood frame
- Transitional style 2" wide scalloped arms/legs
- Upholstered seat and back
- Reinforced seat frame with steel cross braces
- Weight capacity of 350 lbs
- Add rocking motion with flex back or flex seat/back by choosing motion options (adds 15 lb. to weight)
- Seat: 20"W x 19"D x 18"H

OPTION	PRICE	CODE
Motion Seat & Back	276.00	-60
Motion Back Only	267.00	-65
Black Polyurethane Arm Caps	86.00	PC

QS NOW

910 Sloped Ottoman

18.5" W X 19" D X 11.5" H

St. Yardage: 1

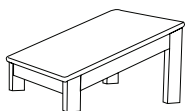

FREIGHT CLASS: 150
 CUBIC FT: 6
 SHIP WEIGHT: 17

Grade	1	2	3	4	5	6	7	8	9	10	L	LL
Zone 1	736	753	770	789	804	826	847	868	890	917	963	1089
Zone 2	747	764	782	801	816	838	860	881	903	931	977	1105
Zone 3	758	776	793	813	828	851	872	894	917	945	992	1122

- Extra sturdy hardwood frame
- Upholstered padded top
- Can be turned with angle toward seat or away from seat

QS NOW

Ganging Seating: Solid Comfort

The **Unos** collection features a striking scalloped arm design in solid wood frame. All seating units, with Unos corner and connecting tables can be ganged in a virtually unlimited number of combinations.

Chair Details

- Select 2, 3 or 4 seater ganged armchairs
- Clean out feature facilitates easy cleaning
- Reinforced seat frame

Table Details

- Use Unos tables for ganging, see page 272
- Sturdy 1" thick tops
- Corner table leg is 1 3/4" thick solid hard wood
- Table and bracket included

UNOS GANGING ORDER DETAIL:



This **Unos Ganging** configuration consists of the following model numbers:

- 904-2 Two Armchairs Ganged
- 909 Corner Table
- 902 Bariatric Chair
- 907 Connecting Table
- 904 Arm Chair
- 905 Highback Arm Chair
- 910 Sloped Ottoman
- 6720 Coffee Table

904-2 Two Armchairs Ganged

47.5" W X 25.5" D X 35" H St. Yardage: 5



Freight Class: 300
 Cubic Ft: 36
 Ship Weight: 85

Grade	1	2	3	4	5	6	7	8	9	10	L	LL
Zone 1	1747	1840	1950	2053	2149	2279	2407	2537	2666	2828	3102	3860
Zone 2	1773	1868	1979	2084	2181	2313	2443	2575	2706	2870	3149	3918
Zone 3	1799	1895	2009	2115	2213	2347	2479	2613	2746	2913	3195	3976

- Extra sturdy solid hardwood frames
- Transitional style 1.5" thick scalloped arms/legs
- Separated upholstered seat and back for easy cleanout
- Steel reinforced seat frames
- Weight capacity of 350 lbs each chair
- Each seat: 20"W x 19"D x 18"H

OPTION	PRICE	CODE
Black Polyurethane Arm Caps, 2 Chairs	129.00	PC3

QS NOW

904-3 Three Armchairs Ganged

70.5" W X 25.5" D X 35" H St. Yardage: 7



Freight Class: 300
 Cubic Ft: 56
 Ship Weight: 124

Grade	1	2	3	4	5	6	7	8	9	10	L	LL
Zone 1	2620	2759	2924	3081	3224	3419	3611	3805	4000	4241	4654	5789
Zone 2	2659	2800	2968	3127	3272	3470	3665	3862	4060	4305	4724	5876
Zone 3	2699	2842	3012	3173	3321	3522	3719	3919	4120	4368	4794	5963

- Extra sturdy solid hardwood frames
- Transitional style 1.5" thick scalloped arms/legs
- Separated upholstered seat and back for easy cleanout
- Steel reinforced seat frames
- Weight capacity of 350 lbs each chair
- Each seat: 20"W x 19"D x 18"H

OPTION	PRICE	CODE
Black Polyurethane Arm Caps, 3 Chairs	172.00	PC4

QS NOW

904-4 Four Armchairs Ganged

93" W X 25.5" D X 35" H St. Yardage: 9



Freight Class: 400
 Cubic Ft: 75
 Ship Weight: 158

Grade	1	2	3	4	5	6	7	8	9	10	L	LL
Zone 1	3492	3679	3898	4105	4298	4558	4816	5074	5330	5654	6206	7719
Zone 2	3544	3734	3956	4167	4362	4626	4888	5150	5410	5739	6299	7835
Zone 3	3597	3789	4015	4228	4427	4695	4960	5226	5490	5824	6392	7951

- Extra sturdy solid hardwood frames
- Transitional style 1.5" thick scalloped arms/legs
- Separated upholstered seat and back for easy cleanout
- Steel reinforced seat frames
- Weight capacity of 350 lbs each chair
- Each seat: 20"W x 19"D x 18"H

OPTION	PRICE	CODE
Black Polyurethane Arm Caps, 4 Chairs	215.00	PC5

QS NOW

FINISH SELECTION

ASPEN **AP** | BLACK **BLK** | BOARDWALK **BW** | DRIFTWOOD **DW** | ESPRESSO **ESP** |
 HONEY CHERRY **HCY** | MAHOGANY **MAH** | MOAB **MOB** | NATURAL **FM** |
 ROUGE MAHOGANY **RM** | WINDSOR CHERRY **WC** | SHORELINE **SL** |

Solid Comfort

The **Trados** collection features a striking triarc arm design and a solid frame. Steel cross brace construction provides 350 lb. capacity. Bariatric width chairs also include steel cross braces in the back and offer standard weight capacity of 500 lb. with a 750 lb. and 1,000 lb. option.

Design Details

- *Triarc arm design*
- *Bariatric seating is rated to 500 lb. standard*
- *Clean out feature*
- *Reinforced seat frame*
- *Backs have hook and loop fasteners for easy field replacements*
- *Field replaceable seats*



Arm Chair



Trados

914 Armchair

22.75" W X 25" D X 35" H St. Yardage: 2

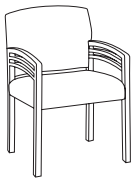

FREIGHT CLASS: 250
 CUBIC FT: 15
 SHIP WEIGHT: 37

Grade	1	2	3	4	5	6	7	8	9	10	L	LL
Zone 1	835	910	981	998	1047	1116	1185	1252	1320	1406	1772	1950
Zone 2	848	924	996	1013	1063	1133	1203	1271	1340	1427	1799	1979
Zone 3	860	937	1010	1028	1078	1149	1221	1290	1360	1448	1825	2009

- Solid wood frame
- Triarc arm design
- Separated upholstered seat and back for easy cleanout
- Steel reinforced seat frame
- Weight capacity of 350 lbs
- Seat: 20"W x 19"D x 18"H

OPTION	PRICE	CODE
Black Polyurethane Arm Caps	80.00	PC
Casters for Guest Chairs	50.00	C

Single Pack Specifications: Freight Class: 300 Cubes: 12 Ship Wt: 22

QS NOW

916 Two-Seat Settee

48" W X 25" D X 35" H St. Yardage: 3.25

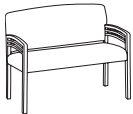

FREIGHT CLASS: 250
 CUBIC FT: 37
 SHIP WEIGHT: 64

Grade	1	2	3	4	5	6	7	8	9	10	L	LL
Zone 1	1339	1385	1446	1491	1537	1605	1666	1735	1796	1872	2055	2397
Zone 2	1359	1406	1468	1513	1560	1629	1691	1761	1823	1900	2086	2433
Zone 3	1379	1427	1489	1536	1583	1653	1716	1787	1850	1928	2117	2469

- Solid wood frame
- Triarc arm design
- Separated upholstered seat and back for easy cleanout
- Steel reinforced seat frame
- Weight capacity of 350 lbs
- Seat: 45"W x 19"D x 18"H

OPTION	PRICE	CODE
Black Polyurethane Arm Caps	80.00	PC

QS NOW

918 Bench

48" W X 22" D X 25.5" H St. Yardage: 2

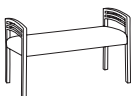

FREIGHT CLASS: 175
 CUBIC FT: 36
 SHIP WEIGHT: 75

Grade	1	2	3	4	5	6	7	8	9	10	L	LL
Zone 1	1036	1057	1075	1108	1183	1303	1367	1430	1497	1544	1597	1728
Zone 2	1052	1073	1091	1125	1201	1323	1388	1451	1519	1567	1621	1754
Zone 3	1067	1089	1107	1141	1218	1342	1408	1473	1542	1590	1645	1780

- Solid wood frame
- Triarc arm design
- Separated upholstered seat and back for easy cleanout
- Steel reinforced seat frame
- Weight capacity of 350 lbs
- Seat: 45"W x 19"D x 18"H

OPTION	PRICE	CODE
Black Polyurethane Arm Caps	80.00	PC

QS NOW

FINISH SELECTION

ASPEN AP | BLACK BLK | BOARDWALK BW | DRIFTWOOD DW | ESPRESSO ESP |
 HONEY CHERRY HCY | MAHOGANY MAH | MOAB MOB | NATURAL FM |
 ROUGE MAHOGANY RM | WINDSOR CHERRY WC | SHORELINE SL |

GUEST

912 30" Bariatric Chair

33" W X 25" D X 35" H

St. Yardage: 2.5



FREIGHT CLASS: 175
 CUBIC FT: 36
 SHIP WEIGHT: 65

Grade	1	2	3	4	5	6	7	8	9	10	L	LL
Zone 1	1069	1104	1151	1186	1221	1274	1321	1374	1420	1479	1620	1883
Zone 2	1085	1121	1168	1204	1239	1293	1341	1395	1441	1501	1644	1911
Zone 3	1101	1137	1186	1222	1258	1312	1361	1415	1463	1523	1669	1939

- Wood frame
- Triarc arm design
- Separated upholstered seat and back for easy cleanout
- Steel reinforced seat and back frame
- Weight capacity of 500 lbs
- Seat: 30"W x 19"D x 18"H

OPTION	PRICE	CODE
Black Polyurethane Arm Caps	80.00	PC
750 lb. Bariatric Rating	130.00	HB
1000 lb. Bariatric Rating	250.00	XB

QS NOW

913 40" Bariatric Chair

43" W X 25" D X 35" H

St. Yardage: 3

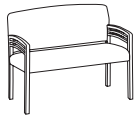

FREIGHT CLASS: 175
 CUBIC FT: 36
 SHIP WEIGHT: 81

Grade	1	2	3	4	5	6	7	8	9	10	L	LL
Zone 1	1203	1245	1301	1344	1386	1449	1505	1568	1625	1695	1864	2180
Zone 2	1221	1264	1321	1364	1407	1471	1528	1592	1649	1720	1892	2213
Zone 3	1239	1282	1340	1384	1428	1492	1550	1615	1674	1746	1920	2245

- Wood frame
- Triarc arm design
- Separated upholstered seat and back for easy cleanout
- Steel reinforced seat and back frame
- Weight capacity of 500 lbs
- Seat: 40"W x 19"D x 18"H

OPTION	PRICE	CODE
Black Polyurethane Arm Caps	80.00	PC
750 lb. Bariatric Rating	130.00	HB
1000 lb. Bariatric Rating	250.00	XB

QS NOW

915 High Back Patient's Chair

22.75" W X 25" D X 46" H

St. Yardage: 3



FREIGHT CLASS: 300
 CUBIC FT: 24
 SHIP WEIGHT: 43

Grade	1	2	3	4	5	6	7	8	9	10	L	LL
Zone 1	936	983	1036	1126	1188	1268	1348	1428	1509	1611	1755	2016
Zone 2	950	998	1052	1143	1206	1287	1368	1449	1532	1635	1781	2046
Zone 3	964	1012	1067	1160	1224	1306	1388	1471	1554	1659	1808	2076

- Wood frame
- Triarc arm design
- Upholstered seat and back
- Steel reinforced seat frame
- Weight capacity of 350 lbs
- Add rocking motion with flex back or flex back/seat by choosing motion options (adds 15 lb. to weight)
- Seat: 20"W x 19"D x 18"H

OPTION	PRICE	CODE
Black Polyurethane Arm Caps	80.00	PC
Casters for Guest Chairs	50.00	C
Motion Seat & Back	276.00	-60

QS NOW

920 Hip Chair

23" W X 24.5" D X 43" H

St. Yardage: 2.25

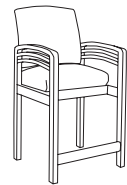

FREIGHT CLASS: 300
 CUBIC FT: 24
 SHIP WEIGHT: 45

Grade	1	2	3	4	5	6	7	8	9	10	L	LL
Zone 1	1995	2032	2069	2142	2197	2261	2324	2390	2455	2536	2807	3053
Zone 2	2025	2062	2100	2174	2230	2295	2359	2426	2492	2574	2849	3099
Zone 3	2055	2093	2131	2206	2263	2329	2394	2462	2529	2612	2891	3145

- Wood frame
- Upholstered seat/back
- Clean out feature
- Seat height at 25.5"
- Step at 6.5" from floor.
- 14" deep seat is recessed 5 5" from front of chair to prevent occupants full weight from resting on the hips
- Seat: 20"W x 14"D x 25.5"H

OPTION	PRICE	CODE
Black Polyurethane Arm Caps	80.00	PC

QS NOW

FINISH SELECTION

ASPEN **AP** | BLACK **BLK** | BOARDWALK **BW** | DRIFTWOOD **DW** | ESPRESSO **ESP** |
 HONEY CHERRY **HCY** | MAHOGANY **MAH** | MOAB **MOB** | NATURAL **FM** |
 ROUGE MAHOGANY **RM** | WINDSOR CHERRY **WC** | SHORELINE **SL** |

Ganging Seating: Solid Comfort

The **Trados** collection features a striking triarc arm design in solid wood or metal frame. All seating units, corner and connecting tables can be ganged in a virtually unlimited number of combinations.

Chair Details

- Select 2, 3 or 4 seater ganged armchairs
- Clean out feature facilitates easy cleaning
- Reinforced seat frame

Table Details

- Corner Table & Connecting Table available
- Sturdy 1" thick tops
- Corner table leg is 1 3/4" thick solid hard wood
- Table and bracket included

TRADOS GANGING ORDER DETAIL:



This **Trados Ganging** configuration consists of the following model numbers:

- 914-2 Two-seater Arm Chair
- 919 Corner Table
- 914 Arm Chair
- 917 Connecting Table
- 915 Highback Arm Chair

914-2 Two Armchairs Ganged

44.5" W X 25" D X 35" H St. Yardage: 5

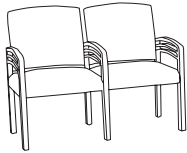

Freight Class: 300
 Cubic Ft: 36
 Ship Weight: 84

QS NOW

Grade	1	2	3	4	5	6	7	8	9	10	L	LL
Zone 1	1603	1640	1676	1748	1812	1910	2006	2136	2264	2394	2501	2684
Zone 2	1627	1665	1701	1774	1839	1939	2036	2168	2298	2430	2539	2724
Zone 3	1651	1689	1726	1800	1866	1967	2066	2200	2332	2466	2576	2765

- Solid wood frame
- Triarc arm design
- Separated upholstered seat and back for easy cleanout
- Steel reinforced seat frame
- Weight capacity of 350 lbs per seat
- Ships assembled
- Each Seat: 20"W x 19"D x 18"H

OPTION	PRICE	CODE
Black Polyurethane Arm Caps, 2 Chairs Ganged	120.00	PC3

914-3 Three Armchairs Ganged

66.5" W X 25" D X 35" H St. Yardage: 7

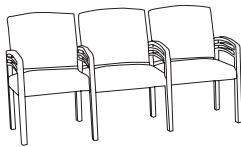

Freight Class: 300
 Cubic Ft: 56
 Ship Weight: 106

QS NOW

Grade	1	2	3	4	5	6	7	8	9	10	L	LL
Zone 1	2405	2442	2477	2550	2720	2866	3010	3204	3397	3590	3704	4027
Zone 2	2441	2479	2514	2588	2761	2909	3055	3252	3448	3644	3760	4087
Zone 3	2477	2515	2551	2627	2802	2952	3100	3300	3499	3698	3815	4148

- Solid wood frame
- Triarc arm design
- Separated upholstered seat and back for easy cleanout
- Steel reinforced seat frame
- Weight capacity of 350 lbs per seat
- Ships assembled
- Each Seat: 20"W x 19"D x 18"H

OPTION	PRICE	CODE
Black Polyurethane Arm Caps, 3 Chairs Ganged	160.00	PC4

914-4 Four Armchairs Ganged

88" W X 25" D X 35" H St. Yardage: 9

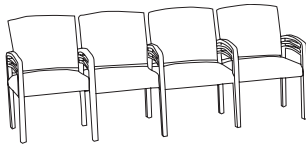

Freight Class: 400
 Cubic Ft: 75
 Ship Weight: 142

QS NOW

Grade	1	2	3	4	5	6	7	8	9	10	L	LL
Zone 1	3206	3242	3279	3400	3625	3819	4013	4271	4529	4786	4906	5045
Zone 2	3254	3291	3328	3451	3679	3876	4073	4335	4597	4858	4980	5121
Zone 3	3302	3339	3377	3502	3734	3934	4133	4399	4665	4930	5053	5196

- Solid wood frame
- Triarc arm design
- Separated upholstered seat and back for easy cleanout
- Steel reinforced seat frame
- Weight capacity of 350 lbs per seat
- Ships assembled
- Each Seat: 20"W x 19"D x 18"H

OPTION	PRICE	CODE
Black Polyurethane Arm Caps, 4 Chairs Ganged	200.00	PC5

Solid Comfort, Modern Metal

The **Trados Metal** guest seating collection features a triarc arm design enhanced by a smooth silver nickel finish with a urethane clear coat. Other finishes available at a 15% upcharge. Minimum 50 seat order. Contact customer service for a list of finishes available. This elegant yet sturdy chair can be further enhanced by the addition of the optional wood or urethane arm caps.

Steel cross brace construction and a heavy gauge steel frame provide 350 lb. capacity. Bariatric seating also includes steel cross brace in back and is rated to 500 lb. with a 750 lb. and 1,000 lb. option.

Trados Metal Design Details

- *Triarc arm design*
- *Bariatric seating is rated to 500 lb. standard*
- *Collection includes patient seating and ganging waiting area seating*
- *Clean-out feature*
- *Reinforced seat frame*

Additional options

- *Wood or Black Polyurethane arm caps*
- *Twelve finish selections available with wood arm cap*



Trados Metal

914MET Armchair

22.75" W X 25" D X 35" H

St. Yardage: 2

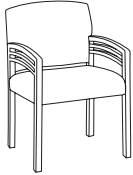

FREIGHT CLASS: 250
CUBIC FT: 15
SHIP WEIGHT: 45

Grade	1	2	3	4	5	6	7	8	9	10	L	LL
Zone 1	955	1007	1069	1110	1158	1222	1287	1350	1416	1497	1715	2013
Zone 2	969	1022	1085	1127	1175	1240	1306	1370	1437	1519	1741	2043
Zone 3	984	1037	1101	1143	1193	1259	1326	1391	1458	1542	1766	2073

- Metal Triarc arms/legs
- Separated upholstered seat and back for easy cleanout
- Steel reinforced seat frame
- Weight capacity of 350 lbs

- Optional wood arm caps available in all seating finishes
- Seat: 20"W x 19"D x 18"H

OPTION	PRICE	CODE
Black Polyurethane Arm Caps	80.00	PC
Wood Arm Caps, Specify Finish	80.00	WA

QS **NOW**

916MET Two-Seat Settee

48" W X 25" D X 35" H

St. Yardage: 3.25

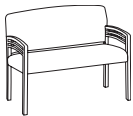

FREIGHT CLASS: 250
CUBIC FT: 37
SHIP WEIGHT: 82

Grade	1	2	3	4	5	6	7	8	9	10	L	LL
Zone 1	1535	1581	1642	1687	1733	1801	1862	1931	1992	2068	2251	2593
Zone 2	1558	1605	1667	1712	1759	1828	1890	1960	2022	2099	2285	2632
Zone 3	1581	1628	1691	1738	1785	1855	1918	1989	2052	2130	2319	2671

- Metal Triarc arms/legs
- Separated upholstered seat and back for easy cleanout
- Steel reinforced seat frame
- Weight capacity of 350 lbs

- Optional wood arm caps available in all seating finishes
- Seat: 45"W x 19"D x 18"H

OPTION	PRICE	CODE
Black Polyurethane Arm Caps	80.00	PC
Wood Arm Caps, Specify Finish	80.00	WA

QS **NOW**

918MET Bench

48" W X 22" D X 25.5" H

St. Yardage: 2

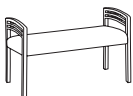

FREIGHT CLASS: 175
CUBIC FT: 37
SHIP WEIGHT: 74

Grade	1	2	3	4	5	6	7	8	9	10	L	LL
Zone 1	1187	1237	1300	1340	1388	1452	1517	1581	1647	1726	1946	2244
Zone 2	1205	1256	1320	1360	1409	1474	1540	1605	1672	1752	1975	2278
Zone 3	1223	1274	1339	1380	1430	1496	1563	1628	1696	1778	2004	2311

- Metal Triarc arms/legs
- Upholstered seat
- Steel reinforced seat frame
- Weight capacity of 350 lbs

- Optional wood arm caps available in all seating finishes
- Seat: 45"W x 21"D x 18"H

OPTION	PRICE	CODE
Black Polyurethane Arm Caps	80.00	PC
Wood Arm Caps, Specify Finish	80.00	WA

QS **NOW**

912MET 30" Bariatric Chair

33" W X 25" D X 35" H

St. Yardage: 2.5

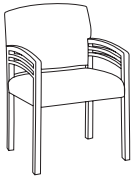

FREIGHT CLASS: 175
CUBIC FT: 36
SHIP WEIGHT: 72

Grade	1	2	3	4	5	6	7	8	9	10	L	LL
Zone 1	1225	1260	1307	1342	1377	1430	1477	1530	1576	1635	1776	2039
Zone 2	1243	1279	1327	1362	1398	1451	1499	1553	1600	1660	1803	2070
Zone 3	1262	1298	1346	1382	1418	1473	1521	1576	1623	1684	1829	2100

- Metal Triarc arms/legs
- Separated upholstered seat and back for easy cleanout
- Steel reinforced seat and back frame
- Weight capacity of 500 lbs
- Optional wood arm caps available in all seating finishes
- Seat: 30"W x 19"D x 18"H

OPTION	PRICE	CODE
Black Polyurethane Arm Caps	80.00	PC
Wood Arm Caps, Specify Finish	80.00	WA
750 lb. Bariatric Rating	130.00	HB
1000 lb. Bariatric Rating	250.00	XB

QS NOW

913MET 40" Bariatric Chair

43" W X 25" D X 35" H

St. Yardage: 3

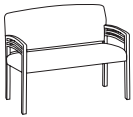

FREIGHT CLASS: 175
CUBIC FT: 36
SHIP WEIGHT: 89

Grade	1	2	3	4	5	6	7	8	9	10	L	LL
Zone 1	1378	1420	1476	1519	1561	1624	1680	1743	1800	1870	2039	2355
Zone 2	1399	1441	1498	1542	1584	1648	1705	1769	1827	1898	2070	2390
Zone 3	1419	1463	1520	1565	1608	1673	1730	1795	1854	1926	2100	2426

- Metal Triarc arms/legs
- Separated upholstered seat and back for easy cleanout
- Steel reinforced seat and back frame
- Weight capacity of 500 lbs
- Optional wood arm caps available in all seating finishes
- Seat: 40"W x 19"D x 18"H

OPTION	PRICE	CODE
Black Polyurethane Arm Caps	80.00	PC
Wood Arm Caps, Specify Finish	80.00	WA
750 lb. Bariatric Rating	130.00	HB
1000 lb. Bariatric Rating	250.00	XB

QS NOW

915MET High-Back Patient's Chair

22.75" W X 25" D X 46" H

St. Yardage: 3



FREIGHT CLASS: 250
CUBIC FT: 24
SHIP WEIGHT: 52

Grade	1	2	3	4	5	6	7	8	9	10	L	LL
Zone 1	1071	1137	1214	1263	1325	1404	1485	1565	1647	1748	2020	2393
Zone 2	1087	1154	1232	1282	1345	1425	1507	1588	1672	1774	2050	2429
Zone 3	1103	1171	1250	1301	1365	1446	1530	1612	1696	1800	2081	2465

- Metal Triarc arms/legs
- Upholstered seat and back
- Steel reinforced seat frame
- Weight capacity of 350 lbs
- Optional wood arm caps available in all seating finishes
- Add rocking motion with flex back or flex back/seat by choosing motion options (adds 15 lb. to weight)
- Seat: 20"W x 19"D x 18"H

OPTION	PRICE	CODE
Black Polyurethane Arm Caps	80.00	PC
Wood Arm Caps, Specify Finish	80.00	WA
Motion Seat & Back	276.00	-60

QS NOW

GUEST

914MET-2 Two Armchairs Ganged

44.5" W X 25" D X 35" H

St. Yardage: 5

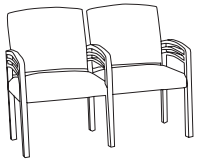

Freight Class: 300
 Cubic Ft: 36
 Ship Weight: 93

Grade	1	2	3	4	5	6	7	8	9	10	L	LL
Zone 1	1836	1941	2063	2142	2239	2368	2497	2627	2755	2917	3353	3949
Zone 2	1864	1970	2094	2174	2273	2404	2534	2666	2796	2961	3403	4008
Zone 3	1891	1999	2125	2206	2306	2439	2572	2706	2838	3005	3454	4067

- Metal Triarc arms/legs
- Separated upholstered seat and back for easy cleanout
- Steel reinforced seat frame
- Weight capacity of 350 lbs per seat
- Optional wood arm caps available in all seating finishes
- Ships assembled
- Each Seat: 20"W x 19"D x 18"H

OPTION	PRICE	CODE
Black Polyurethane Arm Caps, 2 Chairs Ganged	120.00	PC3
Wood Arm Cap, 2 Chairs Ganged	120.00	WA3

QS NOW

914MET-3 Three Armchairs Ganged

66.5" W X 25" D X 35" H

St. Yardage: 7

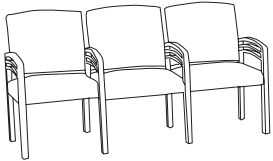

Freight Class: 300
 Cubic Ft: 56
 Ship Weight: 129

Grade	1	2	3	4	5	6	7	8	9	10	L	LL
Zone 1	2755	2912	3095	3215	3361	3554	3747	3940	4134	4376	5031	5925
Zone 2	2796	2956	3141	3263	3411	3607	3803	3999	4196	4442	5106	6014
Zone 3	2838	2999	3188	3311	3462	3661	3859	4058	4258	4507	5182	6103

- Metal Triarc arms/legs
- Separated upholstered seat and back for easy cleanout
- Steel reinforced seat frame
- Weight capacity of 350 lbs per seat
- Optional wood arm caps available in all seating finishes
- Ships assembled
- Each Seat: 20"W x 19"D x 18"H

OPTION	PRICE	CODE
Black Polyurethane Arm Caps, 3 Chairs Ganged	160.00	PC4
Wood Arm Cap, 3 Chairs Ganged	160.00	WA4

QS NOW

914MET-4 Four Armchairs Ganged

88" W X 25" D X 35" H

St. Yardage: 9

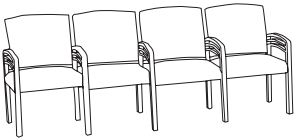

Freight Class: 300
 Cubic Ft: 75
 Ship Weight: 169

Grade	1	2	3	4	5	6	7	8	9	10	L	LL
Zone 1	3673	3883	4128	4286	4479	4738	4996	5254	5511	5834	6708	7900
Zone 2	3728	3941	4190	4350	4546	4809	5071	5333	5594	5922	6809	8019
Zone 3	3783	3999	4252	4415	4613	4880	5146	5412	5676	6009	6909	8137

- Metal Triarc arms/legs
- Separated upholstered seat and back for easy cleanout
- Steel reinforced seat frame
- Weight capacity of 350 lbs per seat
- Optional wood arm caps available in all seating finishes
- Ships assembled
- Each Seat: 20"W x 19"D x 18"H

OPTION	PRICE	CODE
Black Polyurethane Arm Caps, 4 Chairs Ganged	200.00	PC5
Wood Arm Cap, 4 Chairs Ganged	200.00	WA5

QS NOW

917 Trados Connecting Table 907 Unos Connecting Table

20" W X 21.5" D X 15.5" H
 20" W X 21.5" D X 14.25" H

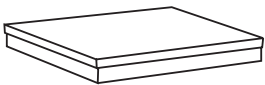

Freight Class: 125
 Cubic Ft: 3
 Ship Weight: 24

- Tops are 1" thick
- Solid hardwood top and rails
- Table and bracket included
- Available in finishes listed above

Zone Pricing	1	2	3
St. Yardage: n/a	506	514	521

QS NOW

919 Trados Corner Table 909 Unos Connecting Table

28.25" W X 28.25" D X 15.5" H
 28.25" W X 28.25" D X 14.25" H



Freight Class: 100
 Cubic Ft: 4
 Ship Weight: 36

- Tops are 1" thick
- Leg is 1-3/4" thick solid hardwood
- Solid hardwood top and rails
- Table and bracket included
- Available in finishes listed above
- Assembly required

St. Yardage: n/a	890	903	917
------------------	-----	-----	-----

QS NOW

Stacking and Armchair Selections

These stacking and armchair collections provide sturdy construction at great value. Select from metal tubular frame chairs or wood framed chairs and armchairs.

Guest & Stacking Features

- 700 – Metal stack chair with upholstered seat and back. Stacking cart available

- 990s– Hardwood frame. Includes stacking, ganging and armchair models

- 9100s– Non-stacking hardwood frame armchairs. Choose from open armed and closed arm design



733 Stacking Chair



993 Stacking Arm Chair



9128 and 9118 Arm Chairs

Guest Chairs

733 4-Leg Stacking Armchair

24.5" W X 24" D X 32" H

St. Yardage: 1



FREIGHT CLASS: 250
CUBIC FT: 15
SHIP WEIGHT: 45

SIN #711-19

Grade	1	2	3	4	5	6	7	8	9	10	L	LL
Zone 1	439	461	480	492	507	528	550	572	593	619	735	792
Zone 2	446	468	487	499	515	536	558	581	602	628	746	804
Zone 3	452	475	494	507	522	544	567	589	611	638	757	816

- Stacks 8 high
- Black metal frame with non-marring glides
- Black urethane arms
- Choose any upholstery
- Shipped 2 chairs per carton; price is per chair
- Seat: 18"W x 19"D x 19"H
- Seat height with casters is 21.5"
- Back height with casters is 34.5"

OPTION	PRICE	CODE
Casters	20.00	C
Single Pack Specifications: Freight Class: 300 Cubes: 15 Ship Wt: 28		

QS NOW

734 Sled Base Armchair

24.5" W X 24" D X 32" H

St. Yardage: 1



FREIGHT CLASS: 300
CUBIC FT: 15
SHIP WEIGHT: 29

SIN #711-18

Grade	1	2	3	4	5	6	7	8	9	10	L	LL
Zone 1	439	461	480	492	507	528	550	572	593	619	735	792
Zone 2	446	468	487	499	515	536	558	581	602	628	746	804
Zone 3	452	475	494	507	522	544	567	589	611	638	757	816

- Easy-slide sled base
- Black metal frame
- Black urethane arms
- Choose any upholstery
- Not stackable
- Ships 1 chair per carton
- Seat: 18"W x 19"D x 19"H

SIN #711-18

QS NOW

715-CART Metal Cart

- Holds up to eight 712 & 713 stacking chairs
- Holds up to five 992 & 993 stacking chairs
- Powder coated black steel frame
- 3" Dual wheel casters



FREIGHT CLASS: 85

		Zone Pricing	1	2	3
26" W X 24"D X 6"H	Cubic Ft: 4	Ship Weight: 19	345	350	355
		SIN #711-19			

QS

GUEST

Maximum Comfort

The **Corbel** collection features a graceful curved arm design with a solid wood frame.

Corbel Ganging Details

• Chair-to-Chair ganging utilizing ganging bracket maximizes seating capacity.



993 Arm Chair



992 Armless Stacking/Ganging Side Chair

22" W X 25" D X 34.75" H St. Yardage: 1



Freight Class: 250
 Cubic Ft: 15
 Ship Weight: 48

QS NOW

Grade	1	2	3	4	5	6	7	8	9	10	L	LL
Zone 1	662	700	740	760	791	803	828	853	885	923	1155	1288
Zone 2	672	711	751	771	803	815	840	866	898	937	1172	1307
Zone 3	682	721	762	783	815	827	853	879	912	951	1190	1327

- Hardwood frame
- Stacks 5 high
- Ships 2 per carton; list price is for single chair
- Each chair adds 5.5" when stacking
- Seat: 19"W x 20"D x 19"H

Single Pack Specifications:
 Freight Class: 300
 Cubes: 14
 Ship Wt.: 26

993 Stacking/Ganging Guest Chair

22" W X 25" D X 34.75" H St. Yardage: 1



Freight Class: 250
 Cubic Ft: 15
 Ship Weight: 48

QS NOW

Grade	1	2	3	4	5	6	7	8	9	10	L	LL
Zone 1	662	700	740	760	791	803	828	853	885	923	1155	1288
Zone 2	672	711	751	771	803	815	840	866	898	937	1172	1307
Zone 3	682	721	762	783	815	827	853	879	912	951	1190	1327

- Hardwood frame
- Stacks 5 high
- Ships 2 per carton; list price is for single chair
- Each chair adds 5.5" when stacking
- Seat: 19"W x 20"D x 19"H

Single Pack Specifications:
 Freight Class: 300
 Cubes: 14
 Ship Wt.: 26

994 Ganging/Bariatric Guest Chair

34" W X 25" D X 35.75" H St. Yardage: 1.5



Freight Class: 250
 Cubic Ft: 36
 Ship Weight: 55

QS NOW

Grade	1	2	3	4	5	6	7	8	9	10	L	LL
Zone 1	1027	1051	1080	1105	1130	1162	1195	1229	1261	1303	1382	1567
Zone 2	1042	1067	1096	1122	1147	1179	1213	1247	1280	1323	1403	1591
Zone 3	1058	1083	1112	1138	1164	1197	1231	1266	1299	1342	1423	1614

- Hardwood frame
- Multi-ply arm/leg components are 1.5" square solid hardwood
- Upholstered seat and half-back
- Easily gangs with other Corbel chairs
- Seat: 30"W x 20" D x 20" H
- Ships 1 chair per carton

99B Chair-to-Chair Ganging Bracket

8" W X 8" D X 2" H



Freight Class: 70
 Cubic Ft: 1
 Ship Weight: 7

- 11 gauge steel black powder coated
- Connects chairs
- Need one bracket in each chair-to-chair connection

Zone Pricing	1	2	3
St. Yardage: n/a	49	50	50

FINISH SELECTION

ASPEN **AP** | BLACK **BLK** | BOARDWALK **BW** | DRIFTWOOD **DW** | ESPRESSO **ESP** |
 HONEY CHERRY **HCY** | MAHOGANY **MAH** | MOAB **MOB** | NATURAL **FM** |
 ROUGE MAHOGANY **RM** | WINDSOR CHERRY **WC** | SHORELINE **SL** |

Solid Good Looks

The **Scoop** collection has solid good looks and two upholstery style options. All seating units and connecting tables can be ganged and configured in a virtually unlimited number of combinations.

Scoop Ganging Details

- Chair base choices: *Sled base or Four legged*
- Upholstery stitching choices: *plain back or channel back*
- Connecting table available
- Priced per chair

Ordering Information

Ganging orders are priced per chair

For each ganged chair, add a **C** to the product number; multiply the number of seats by the correct list price.

Example:

1003CCC (3 chairs with four-legged base)



1003CCCC ganged configuration with plain back

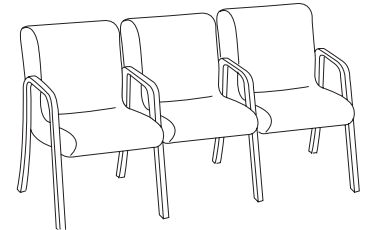

1003 Arm Chair

24" W X 27" D X 33" H

St. Yardage: 2



Freight Class: 250
 Cubic Ft: 15
 Ship Weight: 31

Grade	1	2	3	4	5	6	7	8	9	10	L	LL
Zone 1	644	712	770	800	849	868	949	1000	1062	1180	1310	1460
Zone 2	654	723	782	812	862	881	963	1015	1078	1198	1330	1482
Zone 3	663	733	793	824	874	894	977	1030	1094	1215	1349	1504

- Wood arms/legs
- Available in the finishes listed
- Gangable up to 4 chairs
- Seat: 20"W x 19"D x 18.5"H
- Price shown is per chair

Add a "C" to the product number for each ganged chair, and multiply number of chairs by correct list price. Ex: 1003CCC (3 chairs)

QS **NOW**

1004 Sled Base Arm Chair

24" W X 28" D X 33" H

St. Yardage: 2



Freight Class: 250
 Cubic Ft: 15
 Ship Weight: 33

Grade	1	2	3	4	5	6	7	8	9	10	L	LL
Zone 1	712	776	793	830	867	917	937	1017	1067	1130	1248	1529
Zone 2	723	788	805	842	880	931	951	1032	1083	1147	1267	1552
Zone 3	733	799	817	855	893	945	965	1048	1099	1164	1285	1575

- Wood arms and sled base
- Available in the finishes listed
- Gangable up to 4 chairs
- Seat: 20"W x 19"D x 18.5"H
- Price shown is per chair

Add a "C" to the product number for each ganged chair, and multiply number of chairs by correct list price. Ex: 1004CCC (3 chairs)

QS **NOW**

T1005 Ganging Table (Table Only)

23" W X 15" D X 2" H

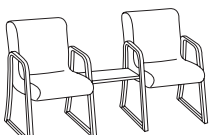

Freight Class: 70
 Cubic Ft: 1
 Ship Weight: 10

- Wood veneer table
- Can be shipped via ground service
- Available in the finishes listed above

Zone Pricing	1	2	3
St. Yardage: n/a	217	220	224

QS **NOW**

FINISH SELECTION

ASPEN **AP** | BLACK **BLK** | BOARDWALK **BW** | DRIFTWOOD **DW** | ESPRESSO **ESP** |
 HONEY CHERRY **HCY** | MAHOGANY **MAH** | MOAB **MOB** | NATURAL **FM** | ROUGE MAHOGANY **RM** |
 WINDSOR CHERRY **WC** | SHORELINE **SL** |

GUEST GANGING

1113 Arm Chair



Freight Class: 250
 Cubic Ft: 15
 Ship Weight: 31

24" W X 27" D X 33" H

St. Yardage: 2

Grade	1	2	3	4	5	6	7	8	9	10	L	LL
Zone 1	649	687	731	768	805	855	875	954	1005	1067	1186	1440
Zone 2	659	697	742	780	817	868	888	968	1020	1083	1204	1462
Zone 3	668	708	753	791	829	881	901	983	1035	1099	1222	1483

- Channel style back
- Wood arms/legs available in the finishes listed
- Gangable up to 4 chairs
- Seat: 20"W x 19"D x 18.5"H

Add a "C" to the product number for each ganged chair, and multiply number of chairs by correct list price. Ex: 1113CCC (3 chairs)

QS NOW

1114 Arm Chair



Freight Class: 250
 Cubic Ft: 15
 Ship Weight: 33

24" W X 28" D X 33" H

St. Yardage: 2

Grade	1	2	3	4	5	6	7	8	9	10	L	LL
Zone 1	718	782	800	836	875	923	944	1024	1074	1136	1254	1505
Zone 2	729	794	812	849	888	937	958	1039	1090	1153	1273	1528
Zone 3	740	805	824	861	901	951	972	1055	1106	1170	1292	1550

- Channel style back
- Wood arms and sled base
- Available in the finishes listed
- Gangable up to 4 chairs
- Price shown is per chair
- Seat: 20"W x 19"D x 18.5"H

Add a "C" to the product number for each ganged chair, and multiply number of chairs by correct list price. Ex: 1114CCC (3 chairs)

QS NOW

FINISH SELECTION

ASPEN **AP** | BLACK **BLK** | BOARDWALK **BW** | DRIFTWOOD **DW** | ESPRESSO **ESP** |
 HONEY CHERRY **HCY** | MAHOGANY **MAH** | MOAB **MOB** | NATURAL **FM** | ROUGE
 MAHOGANY **RM** | WINDSOR CHERRY **WC** | SHORELINE **SL** |

SIN 711-17 **9118/9128**

GUEST GANGING

Versatile & Popular

Versatile and popular, the **9118/9128** ganging collection offers extensive capability for a wide range of environments. Hardwood frames and quality construction are backed with Limited Lifetime Warranty. Select open arm or upholstered arm panel designs. Complement your offices with extensive finish and upholstery options.

9118/9128 Ganging Details

- Chair-to-Chair ganging maximizes seating capacity
- Ganging Brackets sold separately



9118 Guest Chair



9128 Guest Chair



9118 Arm Chair

23" W X 25.5" D X 33" H

St. Yardage: 2



Freight Class: 250

Cubic Ft: 15

Ship Weight: 26

QS NOW

Grade	1	2	3	4	5	6	7	8	9	10	L	LL
Zone 1	711	778	839	862	911	974	999	1101	1164	1244	1505	1752
Zone 2	722	790	852	875	925	989	1014	1118	1181	1263	1528	1778
Zone 3	732	801	864	888	938	1003	1029	1134	1199	1281	1550	1805

- Hardwood frame
- Upholstered seat/back
- Available in all seating finishes
- Seat: 20.5"W x 17.25"D x 19"H

9128 Arm Chair

23" W X 25.5" D X 33" H

St. Yardage: 2.5



Freight Class: 250

Cubic Ft: 15

Ship Weight: 29

QS NOW

Grade	1	2	3	4	5	6	7	8	9	10	L	LL
Zone 1	829	913	986	1029	1092	1116	1219	1282	1361	1512	1826	1987
Zone 2	841	927	1001	1044	1108	1133	1237	1301	1381	1535	1853	2017
Zone 3	854	940	1016	1060	1125	1149	1256	1320	1402	1557	1881	2047

- Hardwood frame
- Upholstered seat/back
- Upholstered side panels
- Available in all seating finishes
- Seat: 20.5"W x 17.25"D x 19"H

9193CTC Ganging Bracket

10" W X 3.5" D X 0.125" H

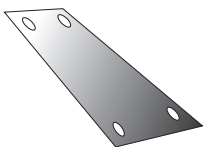

Freight Class: 70

Cubic Ft: 0.2

Ship Weight: 1

- 16 gauge steel
- Black powder coated
- Connect chairs
- Need one bracket in each chair-to-chair connection

Zone Pricing	1	2	3
St. Yardage: n/a	31	31	32

SEATING BREAKROOM



A Study in Simplicity

The **Stax Collection** is at home in waiting areas, cafeterias or any other high-traffic area. Features include durable polypropylene seat and back integrated with rigid steel legs and support structure.



Upholstered Stax 723SBC

Stax Details

- Choice of chrome or black finish legs
- Seat and/or back cushions may be custom upholstered in a wide variety of stock or COM fabrics
- Seat connectors available for easy ganging configurations
- Rolling stack cart holds up to 24 non-upholstered Stax chairs



724 Stax



Shipping Information

- Ships four per carton (single carton quantities available for an upcharge.)



Cart shown with 720 Stax chair

Please Note: Orders for Stax chairs in less than multiples of four(4) will incur a broken carton charge of \$27 per order.

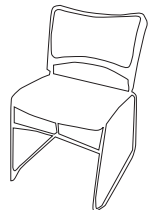
Stax		Zone Pricing	1	2	3
723 Black Wire Stacking Chair	20.5" W X 21.5" D X 31.5" H St. Yardage: n/a		159	161	164
	<ul style="list-style-type: none"> • Black 510/WG solid steel wire rod with durable black powder coat finish • Comfortably shaped black polypropylene seat and back • Easily stacks out of the way when not in use 	<ul style="list-style-type: none"> • Can stack up to 24 high • Ships four to a carton, price is per chair • Seat: 18"W X 16.5"D X 18.5"H 	Single Pack Specifications: Freight Class: 400 Cubes: 10 Ship Weight: 19		
Freight Class: 150 Cubic Ft: 11.0 Ship Weight: 55					
724 Chrome Wire Stacking Chair	20.5" W X 21.5" D X 31.5" H St. Yardage: n/a		159	161	164
	<ul style="list-style-type: none"> • 510/WG solid steel wire rod with durable chrome finish • Comfortably shaped black polypropylene seat and back • Easily stacks out of the way when not in use 	<ul style="list-style-type: none"> • Can stack up to 24 high • Ships four to a carton, price is per chair • Seat: 18"W x 16.5"D x 18.5"H 	Single Pack Specifications: Freight Class: 400 Cubes: 10 Ship Weight: 19		
Freight Class: 150 Cubic Ft: 11.0 Ship Weight: 55					
723SC Black Wire Upholstered Seat	20.5" W X 21.5" D X 31.5" H St. Yardage: 0.75				
	<ul style="list-style-type: none"> • Same features as 723 except: • Upholstered seat cushion • Can stack up to 12 high • Seat 18"W x 16.5"D x 19"H 				
Freight Class: 150 Cubic Ft: 11.0 Ship Weight: 55					
723BC Black Wire Upholstered Back	20.5" W X 21.5" D X 31.5" H St. Yardage: 0.5				
	<ul style="list-style-type: none"> • Same features as 723SC except: • Upholstered back cushion • Seat: 18"W x 16.5"D x 18.5"H 				
Freight Class: 150 Cubic Ft: 11.0 Ship Weight: 55					

QS NOW

QS NOW

723SBC Black Wire Upholstered Seat/Back

20.5" W X 21.5" D X 31.5" H

St. Yardage: 0.75



Freight Class: 150
Cubic Ft: 11.0
Ship Weight: 55

QS NOW

Grade	1	2	3	4	5	6	7	8	9	10	L	LL
Zone 1	279	289	299	316	347	368	390	412	434	461	499	510
Zone 2	283	293	303	321	352	374	396	418	441	468	506	518
Zone 3	287	298	308	325	357	379	402	424	447	475	514	525

- Same features as 723SC except:
- Upholstered seat and back cushions
- Seat: 18"W x 16.5"D x 19"H

Single Pack Specifications:
Freight Class: 400
Cubes: 10
Ship Weight: 19

724SC Chrome Wire Upholstered Seat

20.5" W X 21.5" D X 31.5" H

St. Yardage: 0.75



Freight Class: 150
Cubic Ft: 11.0
Ship Weight: 55

QS NOW

Grade	1	2	3	4	5	6	7	8	9	10	L	LL
Zone 1	220	229	239	246	256	268	278	290	301	315	344	407
Zone 2	223	232	243	250	260	272	282	294	306	320	349	413
Zone 3	227	236	246	253	264	276	286	299	310	324	354	419

- Same features as 724 except:
- Upholstered seat cushion
- Can stack up to 12 high
- Seat: 18"W x 16.5"D x 19"H

Single Pack Specifications:
Freight Class: 400
Cubes: 10
Ship Weight: 19

724BC Chrome Wire Upholstered Back

20.5" W X 21.5" D X 31.5" H

St. Yardage: 0.75



Freight Class: 150
Cubic Ft: 11.0
Ship Weight: 55

QS NOW

Grade	1	2	3	4	5	6	7	8	9	10	L	LL
Zone 1	220	229	239	246	256	268	278	290	301	315	344	407
Zone 2	223	232	243	250	260	272	282	294	306	320	349	413
Zone 3	227	236	246	253	264	276	286	299	310	324	354	419

- 510/WG solid steel wire rod with chrome finish
- Comfortably shaped black polypropylene seat and back
- Upholstered back cushion
- Easily stacks out of the way when not in use
- Can stack up to 12 high
- Ships four to a carton, price is per chair
- Seat: 18"W x 16.5"D x 18.5"H

Single Pack Specifications:
Freight Class: 400
Cubes: 10
Ship Weight: 19

724SBC Chrome Wire Upholstered Seat/Back

20.5" W X 21.5" D X 31.5" H

St. Yardage: 0.75



Freight Class: 150
Cubic Ft: 11.0
Ship Weight: 55

QS NOW

Grade	1	2	3	4	5	6	7	8	9	10	L	LL
Zone 1	279	289	299	316	347	368	390	412	434	461	499	510
Zone 2	283	293	303	321	352	374	396	418	441	468	506	518
Zone 3	287	298	308	325	357	379	402	424	447	475	514	525

- Same features as 724SC except:
- Upholstered seat and back cushions

Single Pack Specifications:
Freight Class: 400
Cubes: 10
Ship Weight: 19

720-GC Seat Connector

1.5" W X 0.75" D X 0.5" H

St. Yardage: n/a

92 93 95

Freight Class: 70
Cubic Ft: 0.2
Ship Weight: 1

- Bag of 50 poly seat connectors

720-CART Stax Cart

24" W X 22" D X 20.5" H

St. Yardage: n/a

280 284 288



Freight Class: 150
Cubic Ft: 11.0
Ship Weight: 16

- Black 510/WG solid steel wire rod with durable black powder coat finish
- Casters for easy mobility
- Holds up to 24 non-upholstered wire stacking chairs or 20 upholstered wire stacking chairs

MILAN SEATING

All chair feature black metal frames with solid wood seat and back in a dark Mahogany finish.

Three styles of seating

- Guest chairs with 18" high seat
- Bistro chairs with 30" high seat
- Bistro swivel chairs with 30" high seat

You can order an upholstered seat for any model. Upholstery will add 1" to the seat height. Each version is available with a choice of ladder back, porthole back or wavy back.

All Milan chairs ship fully assembled.



MILAN CHAIRS Ladder Back Wood

Zone Pricing	1	2	3
--------------	---	---	---

213 Chair, Ladder Back and Wood Seat



SIN 711-18

- Ladder style back with wood seat
- Commercial grade hardwood seat and back
- **Mahogany stain finish**
- Non-marring floor glides
- Ships two chairs per carton, price is per chair
- Seat: 16"W X16.5"D X 17.25"H

FREIGHT CLASS: 250
CUBIT FT: 11.0
SHIP WT: 38

16.75" W X 21" D X 32" H

St. Yardage: n/a

303	308	312
------------	------------	------------

216 Bistro Chair, Ladder Back and Wood Seat



SIN 711-18

- Ladder style back with wood seat
- Commercial grade hardwood seat and back
- **Mahogany stain finish**
- Non-marring floor glides
- Seat: 16"W X16.5"D X 30"H

FREIGHT CLASS: 250
CUBIT FT: 11.0
SHIP WT: 26

17" W X 20" D X 42" H

St. Yardage: n/a

415	421	427
------------	------------	------------

217 Bistro Swivel Chair, Ladder Back and Wood Seat

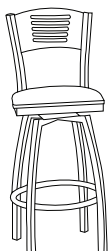

- Ladder style back and swivel wood seat
- Seat swivels 360 degrees
- Commercial grade hardwood seat and back
- **Mahogany stain finish**
- Non-marring floor glides
- Seat: 16"W X16.5"D X 30.25"H

FREIGHT CLASS: 250
CUBIT FT: 11.0
SHIP WT: 32

18" W X 20" D X 44.5" H

St. Yardage: n/a

415	421	427
------------	------------	------------

MILAN CHAIRS Porthole Back Wood		Zone Pricing	1	2	3
---------------------------------	--	--------------	---	---	---

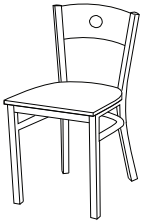
223 Chair, Porthole Back and Wood Seat  <ul style="list-style-type: none"> • Chair with porthole back • Commercial grade hardwood seat and back • Mahogany stain finish • Non-marring floor glides • Ships two chairs per carton, price is per chair • Seat: 16.25"W X16.5"D X 17.25"H <p>FREIGHT CLASS: 250 CUBIT FT: 11.0 SHIP WT: 38</p>	16.5" W X 21" D X 32.5" H	St. Yardage: n/a	303	308	312

222 Bistro Chair, Porthole Back and Wood Seat  <ul style="list-style-type: none"> • Bistro chair with porthole back • Commercial grade hardwood seat and back • Mahogany stain finish • Non-marring floor glides • Seat: 16"W X16.5"D X 30"H <p>FREIGHT CLASS: 250 CUBIT FT: 11.0 SHIP WT: 26</p>	16.75" W X 20" D X 42.75" H	St. Yardage: n/a	415	421	427

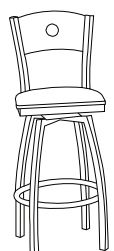
226 Bistro Swivel Chair, Porthole Back and Wood Seat  <ul style="list-style-type: none"> • Bistro swivel chair with porthole back • Seat swivels 360 degrees • Commercial grade hardwood seat and back • Mahogany stain finish • Non-marring floor glides • Seat: 16"W X16.5"D X 30.5"H <p>FREIGHT CLASS: 250 CUBIT FT: 11.0 SHIP WT: 32</p>	17.75" W X 18.75" D X 45.75" H	St. Yardage: n/a	415	421	427

MILAN CHAIRS Wavy Back Wood		Zone Pricing	1	2	3
-----------------------------	--	--------------	---	---	---

233 Chair, Wavy Back and Wood Seat  <ul style="list-style-type: none"> • Chair with wavy back • Commercial grade hardwood seat and back • Mahogany stain finish • Non-marring floor glides • Ships two chairs per carton, price is per chair • Seat: 16.25"W X16.5"D X 17.25"H <p>FREIGHT CLASS: 250 CUBIT FT: 11.0 SHIP WT: 38</p>	18" W X 21" D X 32.5" H	St. Yardage: n/a	303	308	312

228 Bistro Chair, Wavy Back and Wood Seat

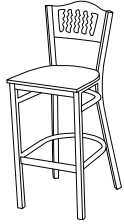

- Bistro chair with wavy back
- Commercial grade hardwood seat and back
- **Mahogany stain finish**
- Non-marring floor glides
- Seat: 16"W X 16.5"D X 30"H

FREIGHT CLASS: 250
CUBIT FT: 11.0
SHIP WT: 26

17" W X 20" D X 42.75" H

St. Yardage: n/a

Zone Pricing	1	2	3
--------------	---	---	---

415 421 427

229 Bistro Swivel Chair, Wavy Back and Wood Seat



- Bistro chair with wavy back
- Seat swivels 360 degrees
- Commercial grade hardwood seat and back
- **Mahogany stain finish**
- Non-marring floor glides
- Seat: 16"W X 16.5"D X 30"H

FREIGHT CLASS: 250
CUBIT FT: 11.0
SHIP WT: 32

17.75" W X 19.5" D X 45.25" H

St. Yardage: n/a

415 421 427

MILAN CHAIRS Ladder Back Upholstered

213U Chair, Ladder Back and Upholstered Seat

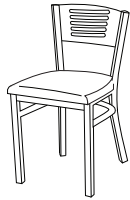

Freight Class: 250
Cubic Ft: 11
Ship Weight: 39

16.75" W X 21" D X 32" H

St. Yardage: 0.75

Grade	1	2	3	4	5	6	7	8	9	10	L	LL
Zone 1	397	416	435	450	466	486	508	530	552	579	645	751
Zone 2	403	422	442	457	473	493	516	538	560	588	655	762
Zone 3	409	428	448	464	480	501	523	546	569	596	664	774

- Ladder style back with upholstered seat
- Commercial grade hardwood back and seat pan
- **Mahogany stain finish**
- Non-marring floor glides
- Ships two chairs per carton, price is per chair
- Seat: 16.5" W X 17"D X 18.5" H

QS NOW

216U Bistro Chair, Ladder Back and Upholstered Seat



Freight Class: 250
Cubic Ft: 11
Ship Weight: 27

17" W X 20" D X 42" H

St. Yardage: 0.75

Grade	1	2	3	4	5	6	7	8	9	10	L	LL
Zone 1	509	527	546	561	578	598	619	642	663	690	757	862
Zone 2	517	535	554	569	587	607	628	652	673	700	768	875
Zone 3	524	543	562	578	595	616	638	661	683	711	780	888

- Ladder style back with upholstered seat
- Commercial grade hardwood back and seat pan
- **Mahogany stain finish**
- Non-marring floor glides
- Seat: 16.25" W X 17"D X 31" H

QS NOW

217U Bistro Swivel Chair, Ladder Back and Upholstered Seat

18" W X 20" D X 44.5" H

St. Yardage: 0.75



Freight Class: 250
Cubic Ft: 11
Ship Weight: 33

Grade	1	2	3	4	5	6	7	8	9	10	L	LL
Zone 1	509	527	546	561	578	598	619	642	663	690	757	862
Zone 2	517	535	554	569	587	607	628	652	673	700	768	875
Zone 3	524	543	562	578	595	616	638	661	683	711	780	888

- Ladder style back with upholstered swivel seat
- Seat swivels 360 degrees
- Commercial grade hardwood back and seat pan
- **Mahogany stain finish**
- Non-marring floor glides
- Seat: 16.25" W X 17"D X 31.25" H

QS NOW

MILAN CHAIRS Porthole Back Upholstered

223U Chair, Porthole Back and Upholstered Seat

16.5" W X 21" D X 32.5" H

St. Yardage: 0.75

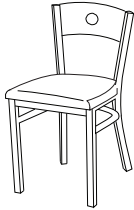

Freight Class: 250
Cubic Ft: 11
Ship Weight: 39

Grade	1	2	3	4	5	6	7	8	9	10	L	LL
Zone 1	397	416	435	450	466	486	508	530	552	579	645	751
Zone 2	403	422	442	457	473	493	516	538	560	588	655	762
Zone 3	409	428	448	464	480	501	523	546	569	596	664	774

- Chair with porthole back
- Upholstered seat
- Commercial grade hardwood back and seat pan
- **Mahogany stain finish**
- Ships two chairs per carton, price is per chair
- Non-marring floor glides
- Seat: 16.5" W X 17"D X 18.5" H

QS NOW

222U Bistro Chair, Porthole Back and Upholstered Seat

16.75" W X 20" D X 42.75" H

St. Yardage: 0.75



Freight Class: 250
Cubic Ft: 11
Ship Weight: 27

Grade	1	2	3	4	5	6	7	8	9	10	L	LL
Zone 1	509	527	546	561	578	598	619	642	663	690	757	862
Zone 2	517	535	554	569	587	607	628	652	673	700	768	875
Zone 3	524	543	562	578	595	616	638	661	683	711	780	888

- Bistro chair with porthole back
- Upholstered seat
- Commercial grade hardwood back and seat pan
- **Mahogany stain finish**
- Non-marring floor glides
- Seat: 16.5" W X 17"D X 31.25" H

QS NOW

226U Bistro Swivel Chair, Porthole Back and Upholstered Seat

17.75" W X 18.75" D X 45.25" H

St. Yardage: 0.75



Freight Class: 250
Cubic Ft: 11
Ship Weight: 33

Grade	1	2	3	4	5	6	7	8	9	10	L	LL
Zone 1	509	527	546	561	578	598	619	642	663	690	757	862
Zone 2	517	535	554	569	587	607	628	652	673	700	768	875
Zone 3	524	543	562	578	595	616	638	661	683	711	780	888

- Bistro swivel chair with porthole back
- Seat swivels 360 degrees
- Upholstered seat
- **Mahogany stain finish**
- Non-marring floor glides
- Seat: 16.5" W X 17"D X 31.75" H

QS NOW

MILAN CHAIRS Wavy Back Upholstered

233U Chair, Wavy Back and Upholstered Seat

18" W X 21" D X 33" H

St. Yardage: 0.75



Grade	1	2	3	4	5	6	7	8	9	10	L	LL
Zone 1	397	416	435	450	466	486	508	530	552	579	645	751
Zone 2	403	422	442	457	473	493	516	538	560	588	655	762
Zone 3	409	428	448	464	480	501	523	546	569	596	664	774

Freight Class: 250

Cubic Ft: 11

Ship Weight: 39

- Chair with wavy back
- Upholstered seat
- Commercial grade hardwood back and seat pan
- Mahogany stain finish
- Non-marring floor glides
- Ships two chairs per carton, price is per chair
- Seat: 16.5" W X 17"D X 18" H

QS NOW

228U Bistro Chair, Wavy Back and Upholstered Seat

17.75" W X 19.5" D X 42.75" H

St. Yardage: 0.75



Grade	1	2	3	4	5	6	7	8	9	10	L	LL
Zone 1	509	527	546	561	578	598	619	642	663	690	757	862
Zone 2	517	535	554	569	587	607	628	652	673	700	768	875
Zone 3	524	543	562	578	595	616	638	661	683	711	780	888

Freight Class: 250

Cubic Ft: 11

Ship Weight: 27

- Bistro chair with wavy back
- Upholstered seat
- Commercial grade hardwood back and seat pan
- Mahogany stain finish
- Non-marring floor glides
- Seat: 16.5" W X 17"D X 31.25" H

QS NOW

229U Bistro Swivel Chair, Wavy Back and Upholstered Seat

17.75" W X 19.5" D X 45.25" H

St. Yardage: 0.75



Grade	1	2	3	4	5	6	7	8	9	10	L	LL
Zone 1	509	527	546	561	578	598	619	642	663	690	757	862
Zone 2	517	535	554	569	587	607	628	652	673	700	768	875
Zone 3	524	543	562	578	595	616	638	661	683	711	780	888

Freight Class: 250

Cubic Ft: 11

Ship Weight: 33

- Bistro swivel chair with wavy back
- Seat swivels 360 degrees
- Upholstered seat
- Commercial grade hardwood back and seat pan
- Mahogany stain finish
- Non-marring floor glides
- Seat: 16.5" W X 17"D X 31.75" H

QS NOW

HEALTHCARE



Comfort, Form and Function

Comfort, form and function are the essential building blocks for any HPFⁱ® product. Nowhere is this more critical than in a healthcare setting where patient comfort is essential to maximize relaxation and recovery while providing caregivers with equipment that looks great and performs flawlessly.



Design Details

- *Hannah - Lay-flat mechanism allows for administering a wide variety of treatments without use of a bed or gurney. Trendelenburg models feature a negative 3 degree pitch from the full flatbed position and is operated by hands-free foot pedal. Rated to 500 lbs. Bariatric models rated 750 lbs.*
- *Haley - Comfort is provided through a body activated recliner mechanism housed in a streamlined frame. Full length footrest supports entire leg. Rated to 350 lbs. Bariatric models rated at 500 lbs.*

Shipping Information

- All recliners ship with back detached
- Simple assembly required.

Warranty Information

- Limited lifetime on seating components.
- Three years warranty on recliner mechanism



Hannah 834



Haley 843

Hannah

801 Hannah Recliner (Non Trendelenburg) with Central Breaking Casters

32" W X 39" D X 44" H

St. Yardage: 6.5

SIN #71-316



FREIGHT CLASS: 150
CUBIC FT: 39
SHIP WEIGHT: 190

Grade	1	2	3	4	5	6	7	8	9	10	L	LL
Zone 1	4004	4105	4225	4325	4429	4563	4700	4836	4970	5141	5464	6227
Zone 2	4064	4167	4288	4390	4495	4631	4771	4909	5045	5218	5546	6320
Zone 3	4124	4228	4352	4455	4562	4700	4841	4981	5119	5295	5628	6414

- 73" Depth when reclined to lay flat position
- Taut upholstery on seat and back
- Pneumatically controlled back operated by finger-pull release located outside right arm facing offers infinite adjustments
- Foot rest operated by black lever outside of left arm facing
- Central braking casters operated by 3-position pedal located on left side facing (Green - One rear caster restricted to straight, Neutral - All casters swivel, Red - Locks rear casters)
- Rated to 500 lb.
- Seat 23.5"W X 20"D X 20"H

OPTION	PRICE	CODE
Softer Seat Foam-Chair	16.00	SF
Aluminum Push Bar	305.00	PB
Black Push Bar	164.00	BB
Dbl Pivot Tablet	645.00	DPS
Pivoting Tablet	481.00	LPT
Folding Tablet	294.00	FT
IV Pole /Holder	350.00	PL
Moisture Barrier	71.00	MB
Wood Arm Cap	232.00	WA
Black Arm Cap	177.00	PA
Aluminum Lever	222.00	RA
Heat & Massage	1,408.00	HM
Oxygen Tank Holder	192.00	OX
Foley/Accessory Hook	103.00	FH

QS NOW

803 Hannah Bariatric Recliner, Central Braking Casters

37" W X 39" D X 46" H

St. Yardage: 8.25

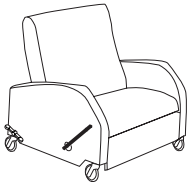

Grade	1	2	3	4	5	6	7	8	9	10	L	LL
Zone 1	4219	4343	4488	4612	4735	4900	5066	5231	5395	5601	5994	6923
Zone 2	4282	4408	4555	4681	4806	4974	5142	5309	5476	5685	6084	7027
Zone 3	4346	4473	4623	4750	4877	5047	5218	5388	5557	5769	6174	7131

- 73" Depth when reclined to lay flat position
- Taut upholstery on seat and back
- Pneumatically controlled back operated by finger-pull release located outside right arm facing offers infinite adjustments
- Foot rest operated by black lever outside of left arm facing
- Central braking casters operated by 3-position pedal located on left side facing (Green - One rear caster restricted to straight, Neutral - All casters swivel, Red - Locks rear casters)
- Rated to 750 lb. weight capacity
- Seat 28.5"W X 20"D X 20"H

OPTION	PRICE	CODE
Softer Seat Foam-Chair	16.00	SF
Aluminum Push Bar	305.00	PB
Black Push Bar	164.00	BB
Dbl Pivot Tablet	645.00	DPS
Pivoting Tablet	481.00	LPT
Folding Tablet	294.00	FT
IV Pole /Holder	350.00	PL
Moisture Barrier	71.00	MB
Wood Arm Cap	232.00	WA
Black Arm Cap	177.00	PA
Aluminum Lever	222.00	RA
Oxygen Tank Holder	192.00	OX
Foley/Accessory Hook	103.00	FH

FREIGHT CLASS: 150
CUBIC FT: 45
SHIP WEIGHT: 205

QS NOW
805 Hannah Pillow Back Recliner, Central Braking Casters

37" W X 39" D X 46" H

St. Yardage: 8.25



Grade	1	2	3	4	5	6	7	8	9	10	L	LL
Zone 1	4204	4335	4485	4614	4742	4915	5087	5260	5432	5648	6056	7026
Zone 2	4267	4400	4552	4683	4813	4989	5163	5339	5513	5733	6147	7131
Zone 3	4330	4465	4620	4752	4884	5062	5240	5418	5595	5817	6238	7237

- Same features as 801 except:
- Pillow back with extra repositionable pillow

OPTION	PRICE	CODE
Softer Seat Foam-Chair	16.00	SF
Aluminum Push Bar	305.00	PB
Black Push Bar	164.00	BB
Dbl Pivot Tablet	645.00	DPS
Pivoting Tablet	481.00	LPT
Folding Tablet	294.00	FT
IV Pole /Holder	350.00	PL
Moisture Barrier	71.00	MB
Wood Arm Cap	232.00	WA
Black Arm Cap	177.00	PA
Aluminum Lever	222.00	RA
Oxygen Tank Holder	192.00	OX
Foley/Accessory Hook	103.00	FH

FREIGHT CLASS: 150
CUBIC FT: 39
SHIP WEIGHT: 178

QS NOW
807 Hannah Bariatric Recliner (Pillow Back) Central Braking Casters

37" W X 39" D X 46" H

St. Yardage: 8.25



Grade	1	2	3	4	5	6	7	8	9	10	L	LL
Zone 1	4397	4553	4736	4893	5050	5259	5468	5678	5886	6148	6645	7821
Zone 2	4463	4621	4807	4966	5126	5338	5550	5763	5974	6240	6745	7938
Zone 3	4529	4690	4878	5040	5202	5417	5632	5848	6063	6332	6844	8056

- Same features as 803 except:
- Pillow back with extra repositionable pillow

OPTION	PRICE	CODE
Softer Seat Foam-Chair	16.00	SF
Aluminum Push Bar	305.00	PB
Black Push Bar	164.00	BB
Dbl Pivot Tablet	645.00	DPS
Pivoting Tablet	481.00	LPT
Folding Tablet	294.00	FT
IV Pole /Holder	350.00	PL
Moisture Barrier	71.00	MB
Wood Arm Cap	232.00	WA
Black Arm Cap	177.00	PA
Aluminum Lever	222.00	RA
Oxygen Tank Holder	192.00	OX
Foley/Accessory Hook	103.00	FH

FREIGHT CLASS: 150
CUBIC FT: 45
SHIP WEIGHT: 200

QS NOW

830 Hannah Patient Recliner

33" W X 39" D X 44" H

St. Yardage: 6.5

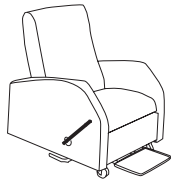

Grade	1	2	3	4	5	6	7	8	9	10	L	LL
Zone 1	3549	3657	3760	3880	3986	4126	4265	4405	4546	4719	4981	5839
Zone 2	3602	3712	3816	3938	4046	4188	4329	4471	4614	4790	5056	5927
Zone 3	3655	3767	3873	3996	4106	4250	4393	4537	4682	4861	5130	6014

- 73" Depth when reclined flat
- Lay flat mechanism includes Trendelenburg tilt which allows a 3° negative pitch from flatbed
- Pull-out foot tray
- Four 3" twin wheel non-marking swivel casters, rear locking
- Pneumatically controlled back operated by finger pull release located outside right arm facing offers infinite adjustments
- Back release can be located inside or outside of either arm
- Footrest operated by black lever on left arm facing
- Rated to 500 lbs
- See series overview
- Seat: 23.5"W x 20"D x 20"H

OPTION	PRICE	CODE
Softer Seat Foam-Chair	16.00	SF
Aluminum Push Bar	305.00	PB
Black Push Bar	164.00	BB
Dbl Pivot Tablet	645.00	DPS
Pivoting Tablet	481.00	LPT
Folding Tablet	294.00	FT
IV Pole /Holder	350.00	PL
Moisture Barrier	71.00	MB
Wood Arm Cap	232.00	WA
Black Arm Cap	177.00	PA
Aluminum Lever	222.00	RA
Heat & Massage	1,408.00	HM
Oxygen Tank Holder	192.00	OX
Foley/Accessory Hook	103.00	FH

FREIGHT CLASS: 150
CUBIC FT: 39
SHIP WEIGHT: 221

QS NOW

831 Hannah Patient Recliner (Non Trendelenburg)

33" W X 39" D X 44" H

St. Yardage: 6.5

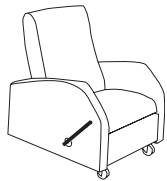

Grade	1	2	3	4	5	6	7	8	9	10	L	LL
Zone 1	2996	3101	3205	3328	3433	3572	3712	3852	3991	4167	4429	5286
Zone 2	3041	3148	3253	3378	3484	3626	3768	3910	4051	4230	4495	5365
Zone 3	3086	3194	3301	3428	3536	3679	3823	3968	4111	4292	4562	5445

- Same features as 830 except:
- Excludes Trendelenburg feature and pull-out foot tray
- Includes two fixed casters on front and two locking swivel casters on back

OPTION	PRICE	CODE
Softer Seat Foam-Chair	16.00	SF
Aluminum Push Bar	305.00	PB
Black Push Bar	164.00	BB
Dbl Pivot Tablet	645.00	DPS
Pivoting Tablet	481.00	LPT
Folding Tablet	294.00	FT
IV Pole /Holder	350.00	PL
Moisture Barrier	71.00	MB
Wood Arm Cap	232.00	WA
Black Arm Cap	177.00	PA
Aluminum Lever	222.00	RA
Heat & Massage	1,408.00	HM
Oxygen Tank Holder	192.00	OX
Foley/Accessory Hook	103.00	FH

FREIGHT CLASS: 150
CUBIC FT: 39
SHIP WEIGHT: 180

QS NOW

832 Hannah Bariatric Patient Recliner

37" W X 39" D X 46" H

St. Yardage: 7.5

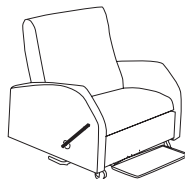

Grade	1	2	3	4	5	6	7	8	9	10	L	LL
Zone 1	4260	4380	4520	4644	4765	4927	5087	5247	5409	5611	5999	6902
Zone 2	4324	4446	4588	4714	4836	5001	5163	5326	5490	5695	6089	7006
Zone 3	4388	4511	4656	4783	4908	5075	5240	5404	5571	5779	6179	7109

- 73" Depth when reclined flat
- Lay flat mechanism includes Trendelenburg tilt which allows a 3° negative pitch from flatbed
- Pull-out foot tray
- 28.5" wide seat
- Four 3" twin wheel non-marking swivel casters, rear locking
- Pneumatically controlled back operated by finger pull release located outside right arm facing offers infinite adjustments
- Back release can be located inside or outside of either arm
- Footrest operated by black lever on left arm facing
- Rated to 750 lbs
- Seat: 28.5"W x 20"D x 20"H

OPTION	PRICE	CODE
Softer Seat Foam-Chair	16.00	SF
Aluminum Push Bar	305.00	PB
Black Push Bar	164.00	BB
Dbl Pivot Tablet	645.00	DPS
Pivoting Tablet	481.00	LPT
Folding Tablet	294.00	FT
IV Pole /Holder	350.00	PL
Moisture Barrier	71.00	MB
Wood Arm Cap	232.00	WA
Black Arm Cap	177.00	PA
Aluminum Lever	222.00	RA
Heat & Massage	1,408.00	HM
Oxygen Tank Holder	192.00	OX
Foley/Accessory Hook	103.00	FH

FREIGHT CLASS: 150
CUBIC FT: 45
SHIP WEIGHT: 238

QS NOW

833 Hannah Bariatric Recliner (Non Trendelenburg)

37" W X 39" D X 46" H

St. Yardage: 7.5

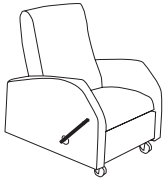

Grade	1	2	3	4	5	6	7	8	9	10	L	LL
Zone 1	3590	3714	3860	3993	4122	4291	4463	4632	4802	5015	5381	6376
Zone 2	3644	3770	3918	4053	4184	4355	4530	4701	4874	5090	5462	6472
Zone 3	3698	3825	3976	4113	4246	4420	4597	4771	4946	5165	5542	6567

- Same features as 832 except:
- Excludes Trendelenburg feature and pull-out foot tray
- Includes two fixed casters on front and two locking swivel casters on back

OPTION	PRICE	CODE
Softer Seat Foam-Chair	16.00	SF
Aluminum Push Bar	305.00	PB
Black Push Bar	164.00	BB
Dbl Pivot Tablet	645.00	DPS
Pivoting Tablet	481.00	LPT
Folding Tablet	294.00	FT
IV Pole /Holder	350.00	PL
Moisture Barrier	71.00	MB
Wood Arm Cap	232.00	WA
Black Arm Cap	177.00	PA
Aluminum Lever	222.00	RA
Heat & Massage	1,408.00	HM
Oxygen Tank Holder	192.00	OX
Foley/Accessory Hook	103.00	FH

FREIGHT CLASS: 150
CUBIC FT: 45
SHIP WEIGHT: 203

QS NOW

834 Hannah Patient Recliner, Pillow Back

33" W X 39" D X 46" H

St. Yardage: 8.25



Grade	1	2	3	4	5	6	7	8	9	10	L	LL
Zone 1	3695	3796	3917	4051	4165	4315	4465	4617	4767	4956	5201	6158
Zone 2	3750	3853	3976	4112	4227	4380	4532	4686	4839	5030	5279	6250
Zone 3	3806	3910	4035	4173	4290	4444	4599	4756	4910	5105	5357	6343

- 73" Depth when reclined flat
- Pillow back with extra repositionable pillow
- Lay flat mechanism includes Trendelenburg tilt which allows a 3° negative pitch from flatbed
- Pull-out foot tray
- Four 3" twin wheel non-marking swivel casters, rear locking
- Pneumatically controlled back release located outside right arm facing offers infinite adjustments
- Footrest operated by black lever on left arm facing
- Rated to 500 lbs
- See series overview
- Seat: 23.5"W x 20"D x 20"H

OPTION	PRICE	CODE
Softer Seat Foam-Chair	16.00	SF
Aluminum Push Bar	305.00	PB
Black Push Bar	164.00	BB
Dbl Pivot Tablet	645.00	DPS
Pivoting Tablet	481.00	LPT
Folding Tablet	294.00	FT
IV Pole /Holder	350.00	PL
Moisture Barrier	71.00	MB
Wood Arm Cap	232.00	WA
Black Arm Cap	177.00	PA
Aluminum Lever	222.00	RA
Oxygen Tank Holder	192.00	OX
Foley/Accessory Hook	103.00	FH

FREIGHT CLASS: 150
CUBIC FT: 39
SHIP WEIGHT: 206

QS NOW

835 Hannah Patient Recliner, Pillow Back (Non Trendelenburg)

33" W X 39" D X 46" H

St. Yardage: 8.25



Grade	1	2	3	4	5	6	7	8	9	10	L	LL
Zone 1	3156	3258	3379	3514	3626	3777	3927	4078	4229	4416	4662	5621
Zone 2	3203	3307	3430	3567	3680	3834	3986	4139	4292	4482	4732	5705
Zone 3	3251	3356	3480	3619	3735	3890	4045	4200	4356	4548	4802	5790

- Same features as 834 except:
- Excludes Trendelenburg feature and pull-out foot tray
- Includes two fixed casters on front and two locking swivel casters on back

OPTION	PRICE	CODE
Softer Seat Foam-Chair	16.00	SF
Aluminum Push Bar	305.00	PB
Black Push Bar	164.00	BB
Dbl Pivot Tablet	645.00	DPS
Pivoting Tablet	481.00	LPT
Folding Tablet	294.00	FT
IV Pole /Holder	350.00	PL
Moisture Barrier	71.00	MB
Wood Arm Cap	232.00	WA
Black Arm Cap	177.00	PA
Aluminum Lever	222.00	RA
Oxygen Tank Holder	192.00	OX
Foley/Accessory Hook	103.00	FH

FREIGHT CLASS: 150
CUBIC FT: 39
SHIP WEIGHT: 165

QS NOW

836 Hannah Bariatric Pillow Back Patient Recliner

37" W X 39" D X 46" H

St. Yardage: 9.5

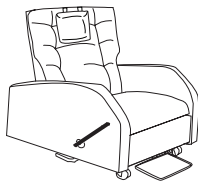

Grade	1	2	3	4	5	6	7	8	9	10	L	LL
Zone 1	3940	4060	4200	4349	4478	4650	4822	4994	5166	5382	5679	6759
Zone 2	3999	4121	4263	4414	4545	4720	4894	5069	5243	5463	5764	6860
Zone 3	4058	4182	4326	4479	4612	4790	4967	5144	5321	5543	5849	6962

- Same features as 834 except:
- 28.5" wide seat
- Rated at 750 lbs
- Seat: 28.5"W x 20"D x 20"H

OPTION	PRICE	CODE
Softer Seat Foam-Chair	16.00	SF
Aluminum Push Bar	305.00	PB
Black Push Bar	164.00	BB
Dbl Pivot Tablet	645.00	DPS
Pivoting Tablet	481.00	LPT
Folding Tablet	294.00	FT
IV Pole /Holder	350.00	PL
Moisture Barrier	71.00	MB
Wood Arm Cap	232.00	WA
Black Arm Cap	177.00	PA
Aluminum Lever	222.00	RA
Oxygen Tank Holder	192.00	OX
Foley/Accessory Hook	103.00	FH

FREIGHT CLASS: 150
CUBIC FT: 45
SHIP WEIGHT: 221

QS NOW

837 Hannah Bariatric Recliner, Pillow Back (Non Trendelenburg)

37" W X 39" D X 46" H

St. Yardage: 9.5

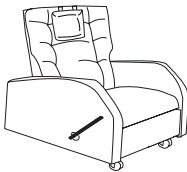

Grade	1	2	3	4	5	6	7	8	9	10	L	LL
Zone 1	3402	3522	3664	3812	3940	4111	4284	4456	4627	4844	5253	6219
Zone 2	3453	3575	3719	3869	3999	4173	4348	4523	4696	4917	5332	6312
Zone 3	3504	3628	3774	3926	4058	4234	4413	4590	4766	4989	5411	6406

- Same features as 834 except:
- 28.5" wide seat
- Excludes Trendelenburg feature and pullout foot tray
- Includes two fixed casters on front and two locking swivel casters on back
- Rated at 750 lbs
- Seat: 28.5"W x 20"D x 20"H

OPTION	PRICE	CODE
Softer Seat Foam-Chair	16.00	SF
Aluminum Push Bar	305.00	PB
Black Push Bar	164.00	BB
Dbl Pivot Tablet	645.00	DPS
Pivoting Tablet	481.00	LPT
Folding Tablet	294.00	FT
IV Pole /Holder	350.00	PL
Moisture Barrier	71.00	MB
Wood Arm Cap	232.00	WA
Black Arm Cap	177.00	PA
Aluminum Lever	222.00	RA
Oxygen Tank Holder	192.00	OX
Foley/Accessory Hook	103.00	FH

FREIGHT CLASS: 150
CUBIC FT: 45
SHIP WEIGHT: 186

QS NOW

838 Hannah Rocker/Glider Recliner

32" W X 39" D X 44" H

St. Yardage: 6.5

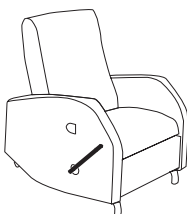

Grade	1	2	3	4	5	6	7	8	9	10	L	LL
Zone 1	3731	3838	3964	4071	4178	4321	4464	4608	4751	4930	5269	6074
Zone 2	3787	3896	4023	4132	4241	4386	4531	4677	4822	5004	5348	6165
Zone 3	3843	3953	4083	4193	4303	4451	4598	4746	4894	5078	5427	6256

- Body activated rocking glider motion operated on curved rail
- Reclining mechanism locks out rocking glider
- 73" Depth when reclined to lay flat position
- Pneumatically controlled back operated by finger-pull release located outside right arm facing offers infinite adjustments
- Foot rest operated by black lever outside of left arm facing
- Tubular metal legs with glides on front, 2" casters on back
- Rated at 500 lbs.
- Seat 22.5"W X 20"D X 20"H

OPTION	PRICE	CODE
Softer Seat Foam-Chair	16.00	SF
Dbl Pivot Tablet	645.00	DPS
Pivoting Tablet	481.00	LPT
Folding Tablet	294.00	FT
IV Pole /Holder	350.00	PL
Moisture Barrier	71.00	MB
Wood Arm Cap	232.00	WA
Black Arm Cap	177.00	PA
Aluminum Lever	222.00	RA
Heat & Massage	1,408.00	HM
Oxygen Tank Holder	192.00	OX
Foley/Accessory Hook	103.00	FH

FREIGHT CLASS: 150
CUBIC FT: 39
SHIP WEIGHT: 190

QS NOW

839 Hannah Rocker/Glider Recliner (Pillow Back)

32" W X 39" D X 46" H

St. Yardage: 8.25

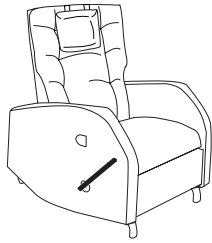

FREIGHT CLASS: 150
 CUBIC FT: 39
 SHIP WEIGHT: 187

Grade	1	2	3	4	5	6	7	8	9	10	L	LL
Zone 1	3917	4054	4212	4349	4486	4667	4848	5030	5211	5439	5871	6891
Zone 2	3976	4115	4275	4414	4553	4737	4921	5105	5289	5521	5959	6994
Zone 3	4035	4176	4338	4479	4621	4807	4993	5181	5367	5602	6047	7098

- Body activated rocking glider motion operated on curved rail
- Reclining mechanism locks out rocking glider
- 73" Depth when reclined to lay flat position
- Pillow back with extra repositionable pillow
- Pneumatically controlled back operated by finger-pull release located outside right arm facing offers infinite adjustments
- Foot rest operated by black lever outside of left arm facing
- Tubular metal legs with glides on front, 2" casters on back
- Rated at 500 lbs.
- Seat 22.5"W X 20"D X 20"H

OPTION	PRICE	CODE
Softer Seat Foam-Chair	16.00	SF
Dbl Pivot Tablet	645.00	DPS
Pivoting Tablet	481.00	LPT
Folding Tablet	294.00	FT
IV Pole /Holder	350.00	PL
Moisture Barrier	71.00	MB
Wood Arm Cap	232.00	WA
Black Arm Cap	177.00	PA
Aluminum Lever	222.00	RA
Oxygen Tank Holder	192.00	OX
Foley/Accessory Hook	103.00	FH

QS NOW

Haley

810 Haley Recliner, Central Braking Casters

29.75" W X 37.5" D X 46.75" H

St. Yardage: 6.75

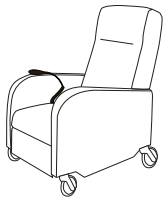

(Line art shows remote control for optional motor assist)

FREIGHT CLASS: 150
 CUBIC FT: 42
 SHIP WEIGHT: 156

Grade	1	2	3	4	5	6	7	8	9	10	L	LL
Zone 1	3158	3263	3388	3521	3637	3789	3943	4095	4249	4439	4683	5205
Zone 2	3205	3312	3439	3574	3692	3846	4002	4156	4313	4506	4753	5283
Zone 3	3253	3361	3490	3627	3746	3903	4061	4218	4376	4572	4823	5361

- 70" Depth when reclined
- Central Braking swivel Casters controlled by three-position pedal located on side/back of left arm facing (Green - One rear caster restricted to straight, Neutral - All casters swivel, Red - Locks rear casters)
- 3 Position push arm mechanism standard
- Full length foot rest supports entire leg
- Rated at 350 lbs.
- Seat: 20.75"W x 20"D x 20"H

OPTION	PRICE	CODE
Softer Seat Foam-Chair	16.00	SF
Dbl Pivot Tablet	645.00	DPS
Pivoting Tablet	481.00	LPT
Folding Tablet	294.00	FT
IV Pole /Holder	350.00	PL
Moisture Barrier	71.00	MB
Wood Arm Cap	232.00	WA
Black Arm Cap	177.00	PA
AC Motor Assist Mech	412.00	MT
Battery Powered Motor Asst	721.00	MTB
Heat & Massage	1,408.00	HM
Black Push Bar	164.00	BB
Aluminum Push Bar	305.00	PB
Oxygen Tank Holder	192.00	OX

QS NOW

813 Haley Bariatric Recliner, Central Braking Casters

33" W X 37.5" D X 46.75" H

St. Yardage: 7

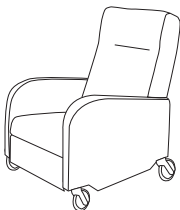

FREIGHT CLASS: 150
 CUBIC FT: 45
 SHIP WEIGHT: 189

Grade	1	2	3	4	5	6	7	8	9	10	L	LL
Zone 1	3399	3507	3632	3738	3846	3989	4132	4277	4418	4597	4937	5744
Zone 2	3450	3560	3686	3794	3904	4049	4194	4341	4484	4666	5011	5830
Zone 3	3501	3612	3741	3850	3961	4109	4256	4405	4551	4735	5085	5916

- 70" Depth when reclined
- Central Braking swivel Casters controlled by three-position pedal located on side/back of left arm facing (Green - One rear caster restricted to straight, Neutral - All casters swivel, Red - Locks rear casters)
- 3 Position push arm mechanism standard
- Full length foot rest supports entire leg
- Rated at 350 lbs.
- Seat: 28.5"W x 20"D x 20"H

OPTION	PRICE	CODE
Softer Seat Foam-Chair	16.00	SF
Dbl Pivot Tablet	645.00	DPS
Pivoting Tablet	481.00	LPT
Folding Tablet	294.00	FT
IV Pole /Holder	350.00	PL
Moisture Barrier	71.00	MB
Wood Arm Cap	232.00	WA
Black Arm Cap	177.00	PA
Heat & Massage	1,408.00	HM
Black Push Bar	164.00	BB
Aluminum Push Bar	305.00	PB
Oxygen Tank Holder	192.00	OX

QS NOW

815 Haley Recliner, Central Braking Casters Pillow Back

29.25" W X 37.5" D X 46.75" H St. Yardage: 8.5

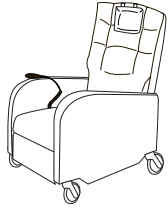

(Line art shows remote control for optional motor assist)

FREIGHT CLASS: 150
CUBIC FT: 39
SHIP WEIGHT: 150

QS NOW

Grade	1	2	3	4	5	6	7	8	9	10	L	LL
Zone 1	3409	3524	3656	3799	3925	4089	4253	4418	4583	4787	5049	5644
Zone 2	3460	3577	3711	3856	3984	4150	4317	4484	4652	4859	5125	5729
Zone 3	3511	3630	3766	3913	4043	4212	4381	4551	4720	4931	5200	5813

- Same features as 810 except:
- Pillow back with extra repositionable pillow

OPTION	PRICE	CODE
Softer Seat Foam-Chair	16.00	SF
Dbl Pivot Tablet	645.00	DPS
Pivoting Tablet	481.00	LPT
Folding Tablet	294.00	FT
IV Pole/Holder	350.00	PL
Moisture Barrier	71.00	MB
Wood Arm Cap	232.00	WA
Black Arm Cap	177.00	PA
AC Motor Assist Mech	412.00	MT
Battery Powered Motor Asst	721.00	MTB
Black Push Bar	164.00	BB
Aluminum Push Bar	305.00	PB
Oxygen Tank Holder	192.00	OX

817 Haley Bariatric Recliner, Central Braking Casters Pillow Back

33" W X 37.5" D X 46.75" H St. Yardage: 8.5

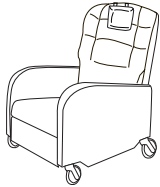

FREIGHT CLASS: 150
CUBIC FT: 45
SHIP WEIGHT: 180

QS NOW

Grade	1	2	3	4	5	6	7	8	9	10	L	LL
Zone 1	3797	3951	4129	4282	4434	4639	4842	5046	5247	5504	5987	7132
Zone 2	3854	4010	4191	4346	4501	4709	4915	5122	5326	5587	6077	7239
Zone 3	3911	4070	4253	4410	4567	4778	4987	5197	5404	5669	6167	7346

- Same features as 813 except:
- Pillow back with extra repositionable pillow

OPTION	PRICE	CODE
Softer Seat Foam-Chair	16.00	SF
Dbl Pivot Tablet	645.00	DPS
Pivoting Tablet	481.00	LPT
Folding Tablet	294.00	FT
IV Pole/Holder	350.00	PL
Moisture Barrier	71.00	MB
Wood Arm Cap	232.00	WA
Black Arm Cap	177.00	PA
Black Push Bar	164.00	BB
Aluminum Push Bar	305.00	PB
Oxygen Tank Holder	192.00	OX

840 Haley Recliner

29" W X 37.5" D X 46.75" H St. Yardage: 6.5

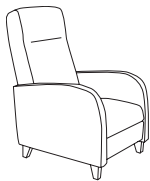

FREIGHT CLASS: 150
CUBIC FT: 39
SHIP WEIGHT: 142

QS NOW

Grade	1	2	3	4	5	6	7	8	9	10	L	LL
Zone 1	2294	2394	2495	2600	2697	2826	2955	3085	3213	3374	3667	4406
Zone 2	2328	2430	2532	2639	2737	2868	2999	3131	3261	3425	3722	4472
Zone 3	2363	2466	2570	2678	2778	2911	3044	3178	3309	3475	3777	4538

- 70" Depth when reclined
- 3 position push arm mechanism
- Full length foot rest supports entire leg
- Hardwood legs available in finishes listed above
- Push bar option should only be ordered if ordering optional 3" casters
- Rated to 350 lbs
- Seat: 20.75"W x 20"D x 20"H

OPTION	PRICE	CODE
Softer Seat Foam-Chair	16.00	SF
Dbl Pivot Tablet	645.00	DPS
Pivoting Tablet	481.00	LPT
Folding Tablet	294.00	FT
IV Pole/Holder	350.00	PL
Moisture Barrier	71.00	MB
Wood Arm Cap	232.00	WA
Black Arm Cap	177.00	PA
AC Motor Assist Mech	412.00	MT
Battery Powered Motor Asst	721.00	MTB
Heat & Massage	1,408.00	HM
3" Casters, Haley	263.00	C
Black Push Bar	164.00	BB
Aluminum Push Bar	305.00	PB
Oxygen Tank Holder	192.00	OX

841 Haley Recliner, Trendelenburg

29.25" W X 37.5" D X 46.75" H St. Yardage: 6.5



Grade	1	2	3	4	5	6	7	8	9	10	L	LL
Zone 1	2580	2674	2784	2904	3007	3142	3279	3414	3550	3721	3937	4465
Zone 2	2619	2714	2826	2948	3052	3189	3328	3465	3603	3777	3996	4532
Zone 3	2657	2754	2868	2991	3097	3236	3377	3516	3657	3833	4055	4599

- 70" Depth when reclined
- 3 position push arm mechanism
- Includes Trendelenburg tilt which allows a 3° negative pitch operated by foot peddle on side of chair
- Full length foot rest supports entire leg
- Hardwood legs available in finishes listed above
- Push bar option should only be ordered if ordering optional 3" casters
- Rated to 350 lbs
- Seat: 20.75"W x 20"D x 20"H

OPTION	PRICE	CODE
Softer Seat Foam-Chair	16.00	SF
Dbl Pivot Tablet	645.00	DPS
Pivoting Tablet	481.00	LPT
Folding Tablet	294.00	FT
IV Pole/Holder	350.00	PL
Moisture Barrier	71.00	MB
Wood Arm Cap	232.00	WA
Black Arm Cap	177.00	PA
Heat & Massage	1,408.00	HM
3" Casters, Haley	263.00	C
Black Push Bar	164.00	BB
Aluminum Push Bar	305.00	PB
Oxygen Tank Holder	192.00	OX

FREIGHT CLASS: 150
 CUBIC FT: 39
 SHIP WEIGHT: 150

QS NOW

843 Haley Bariatric Recliner

33" W X 37.5" D X 46.75" H St. Yardage: 7

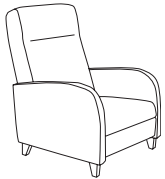

Grade	1	2	3	4	5	6	7	8	9	10	L	LL
Zone 1	2449	2553	2674	2807	2919	3069	3220	3371	3521	3709	3955	4913
Zone 2	2486	2591	2714	2849	2963	3115	3268	3422	3574	3765	4014	4987
Zone 3	2522	2630	2754	2891	3007	3161	3317	3472	3627	3820	4074	5060

- 70" Depth when reclined
- 3 position push arm mechanism
- Full length foot rest supports entire leg
- Hardwood legs available in finishes listed above
- Push bar option should only be ordered if ordering optional 3" casters
- Rated to 500 lbs
- Seat: 24.5"W x 20"D x 20"H

OPTION	PRICE	CODE
Softer Seat Foam-Chair	16.00	SF
Dbl Pivot Tablet	645.00	DPS
Pivoting Tablet	481.00	LPT
Folding Tablet	294.00	FT
IV Pole/Holder	350.00	PL
Moisture Barrier	71.00	MB
Wood Arm Cap	232.00	WA
Black Arm Cap	177.00	PA
Heat & Massage	1,408.00	HM
3" Casters, Haley	263.00	C
Black Push Bar	164.00	BB
Aluminum Push Bar	305.00	PB
Oxygen Tank Holder	192.00	OX

FREIGHT CLASS: 150
 CUBIC FT: 45
 SHIP WEIGHT: 157

QS NOW

844 Haley Recliner, Trendelenburg, Pillow Back

29.25" W X 37.5" D X 46.75" H St. Yardage: 7.25

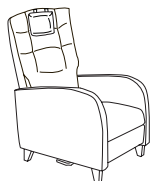

Grade	1	2	3	4	5	6	7	8	9	10	L	LL
Zone 1	2787	2889	3007	3138	3248	3396	3543	3690	3837	4021	4256	4857
Zone 2	2829	2932	3052	3185	3297	3447	3596	3745	3895	4081	4320	4930
Zone 3	2871	2976	3097	3232	3345	3498	3649	3801	3952	4142	4384	5003

- 70" Depth when reclined
- 3 position push arm mechanism
- Includes Trendelenburg tilt which allows a 3° negative pitch operated by foot peddle on side of chair
- Pillow back with repositionable pillow
- Full length foot rest supports entire leg
- Hardwood legs available in finishes listed above
- Push bar option should only be ordered if ordering optional 3" casters
- Rated to 350 lbs
- Seat: 20.75"W x 20"D x 20"H

OPTION	PRICE	CODE
Softer Seat Foam-Chair	16.00	SF
Dbl Pivot Tablet	645.00	DPS
Pivoting Tablet	481.00	LPT
Folding Tablet	294.00	FT
IV Pole/Holder	350.00	PL
Moisture Barrier	71.00	MB
Wood Arm Cap	232.00	WA
Black Arm Cap	177.00	PA
3" Casters, Haley	263.00	C
Black Push Bar	164.00	BB
Aluminum Push Bar	305.00	PB
Oxygen Tank Holder	192.00	OX

FREIGHT CLASS: 150
 CUBIC FT: 39
 SHIP WEIGHT: 150

QS NOW

845 Haley Recliner, Pillow Back

29" W X 37.5" D X 46.75" H

St. Yardage: 8.5



Grade	1	2	3	4	5	6	7	8	9	10	L	LL
Zone 1	2475	2570	2682	2806	2911	3051	3190	3331	3470	3644	3864	4764
Zone 2	2512	2609	2722	2848	2955	3097	3238	3381	3522	3699	3922	4835
Zone 3	2549	2647	2762	2890	2998	3143	3286	3431	3574	3753	3980	4907

- 70" Depth when reclined
- 3 position push arm mechanism
- Full length foot rest supports entire leg
- Includes pillow back with extra repositionable pillow
- Hardwood legs available in finishes listed above
- Push bar option should only be ordered if ordering optional 3" casters
- Rated to 350 lbs
- Seat: 20.75"W x 20"D x 20"H

OPTION	PRICE	CODE
Softer Seat Foam-Chair	16.00	SF
Dbl Pivot Tablet	645.00	DPS
Pivoting Tablet	481.00	LPT
Folding Tablet	294.00	FT
IV Pole/Holder	350.00	PL
Moisture Barrier	71.00	MB
Wood Arm Cap	232.00	WA
Black Arm Cap	177.00	PA
AC Motor Assist Mech	412.00	MT
Battery Powered Motor Asst	721.00	MTB
3" Casters, Haley	263.00	C
Black Push Bar	164.00	BB
Aluminum Push Bar	305.00	PB
Oxygen Tank Holder	192.00	OX

FREIGHT CLASS: 150
 CUBIC FT: 39
 SHIP WEIGHT: 142

QS NOW

847 Haley Bariatric Recliner, Pillow Back

33" W X 37.5" D X 46.75" H

St. Yardage: 9.25

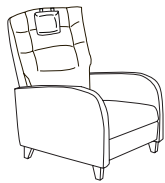







Grade	1	2	3	4	5	6	7	8	9	10	L	LL
Zone 1	2695	2800	2920	3079	3200	3362	3521	3683	3845	4046	4202	5337
Zone 2	2735	2842	2964	3125	3248	3412	3574	3738	3903	4107	4265	5417
Zone 3	2776	2884	3008	3171	3296	3463	3627	3793	3960	4167	4328	5497





- Same features as 843 except
- Pillow back with extra repositionable pillow

OPTION	PRICE	CODE
Softer Seat Foam-Chair	16.00	SF
Dbl Pivot Tablet	645.00	DPS
Pivoting Tablet	481.00	LPT
Folding Tablet	294.00	FT
IV Pole/Holder	350.00	PL
Moisture Barrier	71.00	MB
Wood Arm Cap	232.00	WA
Black Arm Cap	177.00	PA
3" Casters, Haley	263.00	C
Black Push Bar	164.00	BB
Aluminum Push Bar	305.00	PB
Oxygen Tank Holder	192.00	OX

FREIGHT CLASS: 150
 CUBIC FT: 45
 SHIP WEIGHT: 175

QS NOW

Options		Zone Pricing	1	2	3	
	PB Aluminum Push Bar <ul style="list-style-type: none"> • Brushed aluminum with black textured grip for easy patient relocation • Must be factory installed 	24" W X 4.5" D X 1" H	St. Yardage: n/a	305	305	305
	FREIGHT CLASS: 70 CUBIC FT: SHIP WEIGHT: 3					
	BB Black Push Bar <ul style="list-style-type: none"> • Black powder coated steel for easy patient relocation • Must be factory installed 	24" W X 4.5" D X 1" H	St. Yardage: n/a	164	164	164
	FREIGHT CLASS: 70 CUBIC FT: SHIP WEIGHT: 3					
	DPS Double Pivoting Tablet Arm <ul style="list-style-type: none"> • Cobra mounted black tablet arm, unless finish indicated • Brushed aluminum double articulating mechanism • Located on outside of arm, left facing standard • Must be factory installed • Tension adjustment for pivot 	24" W X 7" D X 7.25" H	St. Yardage: n/a	645	645	645
	FREIGHT CLASS: 70 CUBIC FT: SHIP WEIGHT: 7	Finish Options for Tablet: Mahogany (MAH), Windsor Cherry (WC), Honey Cherry (HCY), Natural (FM), Aspen (AP), Moab (MOB), Rouge Mahogany (RM), Boardwalk (BW) and Shoreline (SL)				
	LPT Large Pivoting Tablet Arm with Cobra Mount <ul style="list-style-type: none"> • Cobra mounted black tablet arm, unless finish indicated • Brushed aluminum single pivot mechanism • Located on outside of arm, left facing standard • Tension adjustment for pivot • Must be factory installed 	27" W X 9.5" D X 7.25" H	St. Yardage: n/a	481	481	481
	FREIGHT CLASS: 70 CUBIC FT: SHIP WEIGHT: 6	Finish Options for Tablet: Mahogany (MAH), Windsor Cherry (WC), Honey Cherry (HCY), Natural (FM), Aspen (AP), Moab (MOB), Rouge Mahogany (RM), Boardwalk (BW) and Shoreline (SL)				
	FT Folding Side Table for Recliners <ul style="list-style-type: none"> • Black, unless finish indicated • Easily locks in place • Folds down flat • Located on outside of arm, right side facing standard • Pneumatic back release will need to relocate to left arm facing or inside arm on chairs with folding side table • Must be factory installed 	11.75" W X 21.5" D X 8.5" H	St. Yardage: n/a	294	294	294
	FREIGHT CLASS: 70 CUBIC FT: SHIP WEIGHT: 6	Finish Options for Tablet: Mahogany (MAH), Windsor Cherry (WC), Honey Cherry (HCY), Natural (FM), Aspen (AP), Moab (MOB), Rouge Mahogany (RM), Boardwalk (BW) and Shoreline (SL)				
	PL IV Pole with Pole Holder <ul style="list-style-type: none"> • Two prong IV pole • Chrome plated steel • Adjustable height 55.5" x 90.5" • Locking collar prevents accidental collapse • Brushed aluminum cobra-mount pole holder located on outside bottom rear of chair arm, right side facing standard • Must be factory installed 	11" W X 2.75" D X 55.5-90.5" H	St. Yardage: n/a	350	350	350
	FREIGHT CLASS: 70 CUBIC FT: SHIP WEIGHT: 5					

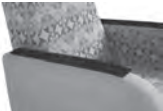
		Zone Pricing	1	2	3
MB Moisture Barrier <ul style="list-style-type: none"> Moisture barrier between seat-foam and fabric 70 Denier/210 thread count nylon with polyurethane coating Anti bacterial, antifungal inhibition 99+% 	FREIGHT CLASS: 70 CUBIC FT: SHIP WEIGHT:	St. Yardage: n/a	71	71	71
MT AC Powered Motor Assist  <ul style="list-style-type: none"> Motorized mechanism for a smooth recline and return Operated through wired remote control Specify MT at end of model number Must be factory installed 	FREIGHT CLASS: CUBIC FT: SHIP WEIGHT:	St. Yardage: n/a	412	412	412
MTB Battery Powered Motor Assist  <ul style="list-style-type: none"> Motorized mechanism for a smooth recline and return Operated through battery powered remote control Specify MTB at end of model number Must be factory installed 	FREIGHT CLASS: CUBIC FT: SHIP WEIGHT:	St. Yardage: n/a	721	721	721
HM Heat & Massage for Recliner  <ul style="list-style-type: none"> AC powered heat and massage operated through push button Control located on inside of right arm facing, standard Will not overheat Waterproof Not available on pillow back models Must be factory installed 	FREIGHT CLASS: CUBIC FT: SHIP WEIGHT:	St. Yardage: n/a	1408	1408	1408
WA Wood Arm Caps for Recliners  <ul style="list-style-type: none"> Set of two finished wood arm caps Pre-installed Specify WA at end of model number and indicate finish 	FREIGHT CLASS: 70 CUBIC FT: SHIP WEIGHT: 2	23.25" W X 2.75" D X 1" H St. Yardage: n/a	232	232	232
	<div style="border: 1px solid black; padding: 2px; font-size: small;"> Finish Options for Tablet: Mahogany (MAH), Windsor Cherry (WC), Honey Cherry (HCY), Natural (FM), Aspen (AP), Moab (MOB), Rouge Mahogany (RM), Boardwalk (BW) and Shoreline (SL) </div>				
PA Black Polyurethane Arm Caps  <ul style="list-style-type: none"> Set of two black polyurethane arm caps for recliners Pre-installed Specify PA at end of model number 	FREIGHT CLASS: 70 CUBIC FT: SHIP WEIGHT: 4	23.25" W X 2.75" D X 1" H St. Yardage: n/a	177	177	177

RA Brushed Aluminum Footrest Lever



- Optional brushed aluminum footrest lever with black textured grip to replace standard black lever on Hannah recliners
- Specify RA at end of model number

FREIGHT CLASS: 70
CUBIC FT:
SHIP WEIGHT: 6

Zone Pricing	1	2	3
--------------	---	---	---

St. Yardage: n/a **222** **222** **222**

C Optional 3" Casters for Haley Recliner



- 3" non-marking twin wheel casters
- Front casters lock
- Mounted with metal plate
- Add C at the end of any Haley recliner model number
- Must be factory installed

FREIGHT CLASS: 70
CUBIC FT:
SHIP WEIGHT: 11

St. Yardage: n/a **263** **263** **263**

FH Foley/Accessory Hook

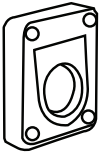

- Accessory hook located outside right arm facing standard
- Provides convenient placement for drainage bags
- Useful in securing restraints
- Must be factory installed

FREIGHT CLASS: 70
CUBIC FT:
SHIP WEIGHT:

St. Yardage: n/a **103** **103** **103**

OX Oxygen Tank Holder

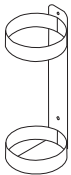

- Holds size D oxygen tank
- Stainless Steel
- Located outside right arm facing standard
- Must be factory installed

FREIGHT CLASS: 70
CUBIC FT:
SHIP WEIGHT: 1

St. Yardage: n/a **192** **192** **192**

Clear Headrest Covers

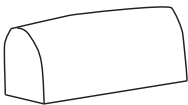

- Box of 5 clear headrest covers for recliners
- H30HC - fits 830 and 831 recliners
- H33HC - fits 832 and 833 recliners
- H40HC - fits 810, 840 and 841 recliners
- H43HC - fits 843 recliner

FREIGHT CLASS: 70

Model	Dimensions	Cubic Ft:	Ship Weight:	1	2	3
830HC	25" x 7.5" x 27"	6	8	369	375	380
833HC	30" x 7.5" x 27"	6	8	369	375	380
840HC	21.5" x 7.5" x 27"	6	8	369	375	380
843HC	25.5" x 7.5" x 27"	6	8	369	375	380

Overnight Comfort

Harmony is the ideal answer for an overnight, comfortable stay in a patient room. It is available in three widths to accommodate most rooms.

The full size version of Harmony provides an adequate sleeping space with room for two adults - perfect for an overnight stay in a children's facility.

Harmony Features

- Wall-saver design
- Lift the front of seat and pull out base to convert to a 78" bed
- Lift chair back and roll forward to close and lock, converts unit back to chair
- Ample storage under seat for sheets, pillows, blankets, etc.
- Platform rail on glides for stability
- Rollers on front for easy opening

Warranty

- Limited lifetime on seating components.
- Three years on recliner mechanism.

Options Available

- Cove or Flush Mount power modules available to be installed on arm. See page 135.



Open position

Harmony Day Beds

821 Single Convertible Seat/Day Bed

38.5" W X 39-78" D X 35" H

St. Yardage: 7.5

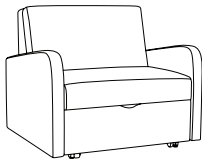

FREIGHT CLASS: 250
CUBIC FT: 52
SHIP WEIGHT: 215

QS NOW

Grade	1	2	3	4	5	6	7	8	9	10	L	LL
Zone 1	2985	3109	3253	3390	3516	3685	3856	4027	4197	4408	4775	5770
Zone 2	3030	3156	3302	3441	3569	3740	3914	4087	4260	4474	4847	5857
Zone 3	3075	3202	3351	3492	3621	3796	3972	4148	4323	4540	4918	5943

- Club chair easily converts to single size bed
- Platform rail on glides for stability
- Rollers on front for easy opening
- See instructions above for operation
- Rated at 500 lb. weight capacity
- Seat: 30.75"W x 22.5"D x 18"H

OPTION	PRICE	CODE
Softer Seat Foam-Chair	16.00	SF
Wood Arm Cap	232.00	WA
Black Arm Cap	177.00	PA

822 Twin Size Convertible Seat/Day Bed

46.5" W X 39-78" D X 35" H

St. Yardage: 8.5

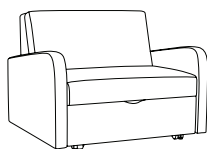

FREIGHT CLASS: 250
CUBIC FT: 66
SHIP WEIGHT: 219

QS NOW

Grade	1	2	3	4	5	6	7	8	9	10	L	LL
Zone 1	3425	3556	3709	3881	4027	4219	4411	4604	4797	5039	5331	6581
Zone 2	3476	3609	3765	3939	4087	4282	4477	4673	4869	5115	5411	6680
Zone 3	3528	3663	3820	3997	4148	4346	4543	4742	4941	5190	5491	6778

- Loveseat easily converts to twin size bed
- Platform rail on glides for stability
- Rollers on front for easy opening
- See instructions above for operation
- Seat: 38.5"W x 22.5"D x 18"H

OPTION	PRICE	CODE
Softer Seat Foam-Loveseat	32.00	SF
Wood Arm Cap	232.00	WA
Black Arm Cap	177.00	PA

823 Full Convertible Seat/Day Bed

55" W X 39-78" D X 35" H St. Yardage: 9.5

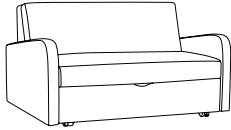

FREIGHT CLASS: 250
 CUBIC FT: 76
 SHIP WEIGHT: 251

Grade	1	2	3	4	5	6	7	8	9	10	L	LL
Zone 1	3999	4145	4319	4509	4672	4886	5102	5318	5534	5802	6147	7525
Zone 2	4059	4207	4384	4577	4742	4959	5179	5398	5617	5889	6239	7638
Zone 3	4119	4269	4449	4644	4812	5033	5255	5478	5700	5976	6331	7751

- Sofa easily converts to full size size bed
- Platform rail on glides for stability
- Rollers on front for easy opening
- See instructions above for operation
- Seat: 47.25"W x 22.5"D x 18"H

OPTION	PRICE	CODE
Softer Seat Foam-Sofa	48.00	SF
Wood Arm Cap	232.00	WA
Black Arm Cap	177.00	PA

QS NOW

826 Harmony Sleeper Chair

35.75" W X 37" D X 35" H St. Yardage: 9.25

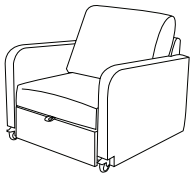

FREIGHT CLASS: 250
 CUBIC FT: 50
 SHIP WEIGHT: 179

Grade	1	2	3	4	5	6	7	8	9	10	L	LL
Zone 1	3074	3220	3389	3573	3731	3940	4151	4360	4568	4831	5166	6510
Zone 2	3120	3268	3440	3627	3787	3999	4213	4425	4637	4903	5243	6608
Zone 3	3166	3317	3491	3680	3843	4058	4276	4491	4705	4976	5321	6705

- Comfortable club chair with easy pop-up ottoman
- Chair by day and sleeper by night
- The pull-out ottoman extends from the back for added length
- Back cushion folds down to convert to a pillow height mattress extension
- 4 heavy-duty casters for easy mobility (front 2 lock)
- Weight capacity 500 lb.
- Seat: 27"W x 20"D x 17"H

OPTION	PRICE	CODE
Softer Seat Foam-Chair	16.00	SF
Wood Arm Cap	232.00	WA
Black Arm Cap	177.00	PA

QS NOW

826-2 Tandem Sleeper Chair

64.75" W X 37" D X 35" H St. Yardage: 18.5

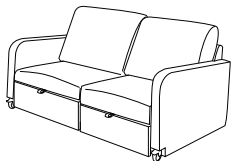

FREIGHT CLASS: 250
 CUBIC FT: 82
 SHIP WEIGHT: 282

Grade	1	2	3	4	5	6	7	8	9	10	L	LL
Zone 1	6151	6438	6775	7068	7461	7880	8301	8721	9139	9665	10333	13018
Zone 2	6243	6535	6877	7174	7573	7998	8426	8852	9276	9810	10488	13213
Zone 3	6336	6631	6978	7280	7685	8116	8550	8983	9413	9955	10643	13409

- Dual sleeper chairs
- Each seat operates independently
- Easy pop-up and retractable ottomans
- Pull-out ottomans extend from the back for added length
- Back cushions fold down to convert to pillow height mattress extension
- Heavy-duty casters for mobility
- Front casters lock
- Each seat: 27"W x 20"D x 17"H

OPTION	PRICE	CODE
Softer Seat Foam-Loveseat	32.00	SF
Wood Arm Cap	232.00	WA
Black Arm Cap	177.00	PA

QS NOW

8233 Sofa/Bed

80.5" W X 34.5" D X 33" H St. Yardage: 13.5

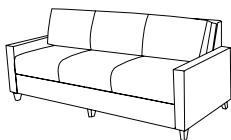

FREIGHT CLASS: 250
 CUBIC FT: 81
 SHIP WEIGHT: 221

Grade	1	2	3	4	5	6	7	8	9	10	L	LL
Zone 1	3818	4027	4268	4518	4739	5035	5328	5624	5919	6287	6830	8644
Zone 2	3875	4087	4332	4586	4810	5111	5408	5708	6008	6381	6932	8774
Zone 3	3933	4148	4396	4654	4881	5186	5488	5793	6097	6476	7035	8903

- Wood legs
- Attached pillow back unfolds to convert to mattress
- Refold back to convert back into sofa
- Seat: 71.5"W x 19"D x 22"H

OPTION	PRICE	CODE
Softer Seat Foam-Sofa	48.00	SF
Wood Arm Cap	267.00	WA

QS NOW

FINISH SELECTION

ASPEN **AP** | BLACK **BLK** | BOARDWALK **BW** | ESPRESSO **ESP** |
 HONEY CHERRY **HCY** | MAHOGANY **MAH** | MOAB **MOB** | NATURAL **FM** |
 ROUGE MAHOGANY **RM** | WINDSOR CHERRY **WC** | SHORELINE **SL** |

SIN 711-16 **HARMONY DAY BEDS**

HEALTHCARE

8233D Sofa/Bed with Laminate Drawers

80.5" W X 34.5" D X 33" H

St. Yardage: 13.5

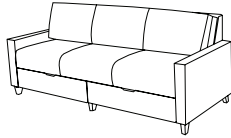

FREIGHT CLASS: 250
 CUBIC FT: 81
 SHIP WEIGHT: 236

Grade	1	2	3	4	5	6	7	8	9	10	L	LL
Zone 1	4283	4490	4734	4982	5204	5499	5793	6089	6384	6752	7295	9110
Zone 2	4347	4557	4805	5057	5282	5581	5880	6180	6480	6853	7404	9247
Zone 3	4411	4625	4876	5131	5360	5664	5967	6272	6576	6955	7514	9383

- Two drawers in base with laminate fronts
- Drawer fronts available in Hyperwork finishes to match wood legs
- Ample storage for sheets, blankets and pillows
- Attached pillow back unfolds to convert to mattress
- Refold back to convert back into sofa
- Seat: 71.5"W x 19"D x 22"H

OPTION	PRICE	CODE
Softer Seat Foam-Sofa	48.00	SF
Wood Arm Cap	267.00	WA

QS NOW

8233UD Sofa/Bed with Upholstered Drawer

80.5" W X 34.5" D X 33" H

St. Yardage: 14

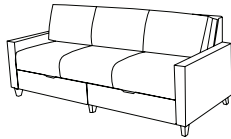

FREIGHT CLASS: 250
 CUBIC FT: 81
 SHIP WEIGHT: 236

Grade	1	2	3	4	5	6	7	8	9	10	L	LL
Zone 1	4283	4490	4734	4982	5204	5499	5793	6089	6384	6752	7295	9110
Zone 2	4347	4557	4805	5057	5282	5581	5880	6180	6480	6853	7404	9247
Zone 3	4411	4625	4876	5131	5360	5664	5967	6272	6576	6955	7514	9383

- Two drawers in base with upholstered fronts
- Ample storage for sheets, blankets and pillows
- Attached pillow back unfolds to convert to mattress
- Refold back to convert back into sofa
- Seat: 71.5"W x 19"D x 22"H

OPTION	PRICE	CODE
Softer Seat Foam-Sofa	48.00	SF
Wood Arm Cap	267.00	WA

QS NOW

HELIX DR. STOOLS SIN 71-317

HEALTHCARE

Comfort for Physicians

Helix provides a full range of adjustable height seating for physicians' offices, examination rooms and other areas of care. Most models include a foot activated ring in the base to provide a hands-free height adjustment. Braking casters on those models also ensure that the stool does not roll away when sitting down or getting up. Both of these features allow the user to keep hands clean and sterile.

Model **581** includes a back rest to ensure proper lumbar support.

Model **582** features a molded urethane seat and black base with a hand-lever height adjustment for ergonomic application.

Select from hundreds of standard and thousands of other available upholsteries including easy-to-clean vinyls and woven Cryptons.

Helix Details

- Dual-wheel, braking casters on 580 & 581 inhibits movement when stool is vacant
- Foot-activated, hands-free pneumatic height adjustment on 580 & 581 stools
- Hand-activated pneumatic height adjustment on 582
- Choice of Black or Chrome bases with or without back rest



580CB



581CB with lumbar support



582 with urethane seat

Helix Dr. Stools

580 Helix Dr. Stool, Black Base

23" W X 23" D X 22.5-29.75" H St. Yardage: 1.5



FREIGHT CLASS: 250
CUBIC FT: 11
SHIP WEIGHT: 27

QS NOW

Grade	1	2	3	4	5	6	7	8	9	10	L	LL
Zone 1	598	620	649	678	704	737	772	806	839	883	946	1154
Zone 2	607	629	659	688	715	748	784	818	852	896	960	1171
Zone 3	616	639	668	698	725	759	795	830	864	909	974	1189

- Black base
- Upholstered seat
- Braking casters lock when vacant
- Foot activated pneumatic height adjustment
- Ships fully assembled
- Seat: 16" Diameter, 22.5-29.75"H
- Weight capacity 350 lbs.

OPTION	PRICE	CODE
Hard-Floor Casters	19.00	H
Self-Locking Casters	85.00	S
Glides/Replace Casters	N/C	GL

580CB Helix Dr. Stool, Chrome Base

23" W X 23" D X 22.5-29.75" H St. Yardage: 1.5



FREIGHT CLASS: 250
CUBIC FT: 11
SHIP WEIGHT: 27

QS NOW

Grade	1	2	3	4	5	6	7	8	9	10	L	LL
Zone 1	634	657	686	714	740	773	807	842	876	918	982	1190
Zone 2	644	667	696	725	751	785	819	855	889	932	997	1208
Zone 3	653	677	707	735	762	796	831	867	902	946	1011	1226

- Chrome base
- Upholstered seat
- Braking casters lock when vacant
- Foot activated pneumatic height adjustment
- Ships fully assembled
- Seat: 16" Diameter, 22.5-29.75"H
- Weight capacity 350 lbs.

OPTION	PRICE	CODE
Hard-Floor Casters	19.00	H
Self-Locking Casters	85.00	S
Glides/Replace Casters	N/C	GL

581 Helix Dr. Stool, Black with Lumbar Support

23" W X 23" D X 37-44" H

St. Yardage: 1.5

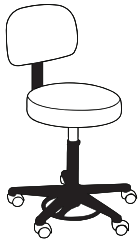

FREIGHT CLASS: 250
CUBIC FT: 11
SHIP WEIGHT: 33

QS NOW

Grade	1	2	3	4	5	6	7	8	9	10	L	LL
Zone 1	734	758	787	815	840	875	910	944	977	1019	1082	1291
Zone 2	745	769	799	827	853	888	924	958	992	1034	1098	1310
Zone 3	756	781	811	839	865	901	937	972	1006	1050	1114	1330

- Black base
- Upholstered seat and lumbar support
- Braking casters lock when vacant
- Foot activated pneumatic height adjustment
- Simple assembly by attaching back
- Seat: 16" Diameter, 22.5-29.75"H
- Weight capacity 350 lbs.

OPTION	PRICE	CODE
Hard-Floor Casters	19.00	H
Self-Locking Casters	85.00	S
Glides/Replace Casters	N/C	GL

581CB Helix Dr. Stool, Chrome with Lumbar Support

23" W X 23" D X 37-44" H

St. Yardage: 1.5

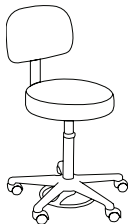

FREIGHT CLASS: 250
CUBIC FT: 11
SHIP WEIGHT: 33

QS NOW

Grade	1	2	3	4	5	6	7	8	9	10	L	LL
Zone 1	774	799	828	855	882	915	949	983	1017	1060	1123	1332
Zone 2	786	811	840	868	895	929	963	998	1032	1076	1140	1352
Zone 3	797	823	853	881	908	942	977	1012	1048	1092	1157	1372

- Chrome base
- Upholstered seat and back
- Braking casters lock when vacant
- Foot activated pneumatic height adjustment
- Simple assembly by attaching back
- Seat: 16" Diameter, 22.5-29.75"H
- Weight capacity 350 lbs.

OPTION	PRICE	CODE
Hard-Floor Casters	19.00	H
Self-Locking Casters	85.00	S
Glides/Replace Casters	N/C	GL

582 Helix Dr. Stool, Urethane Seat

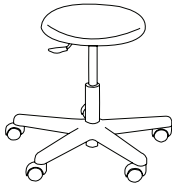

FREIGHT CLASS: 300
CUBIC FT: 11
SHIP WEIGHT: 20

- Black base
- Black urethane seat
- Hand activated pneumatic height adjustment
- Five dual-wheel carpet casters
- Ships fully assembled
- Seat: 14" Diameter, 14.5-20"H

Zone Pricing	1	2	3
--------------	---	---	---

QS	22" x 22" x 14.5-20"	Cubic Ft: 11	Ship Weight: 20	220	223	227
-----------	----------------------	--------------	-----------------	------------	------------	------------

OPTION	PRICE	CODE
Braking Casters	30.00	B
Self-Locking Casters	85.00	S
Glides/Replace Casters	N/C	GL

SEATING PRODUCTS

BY MODEL NUMBER

model	page #	model	page #	model	page #	model	page #
58B	173	724SC	280	918	267	3473	248
74A	198	733	273	918MET	270	3477	248
74B	198	734	273	919	272	3901	244
74C	198	751	219	920	268	3904	244
94CTC	259, 263	751G	220	992	274	3907	245
99B	274	751GHR	220	993	274	3921	245
101	226	752	219	994	274	3927	245
101	226	752G	221	1001	231	4013	246
121	227	757	221	1003	231, 275	4016	246
121	227	757B	220	1004	231, 275	4017	246
141	228	759	220	1007	232	4053	214, 249
141	228	759G	221	1071	232	4054	214, 249
143	204, 228	801	287	1077	232	4057	249
144	204, 229	803	288	1091	233	4072	215, 250
151	202	805	288	1093	233	4073	215, 251
152	202	807	288	1094	233	4074	215, 251
153	202	810	292	1097	233	4075	215, 249
154	203	813	292	1111	234, 276	4076	250
155	203	815	293	1113	234, 276	4077	251
156	203	817	293	1114	234	4078	251
157	203	821	299	1117	234	4083	216, 250
158	203	822	299	1211	235	4121	253
161	229	823	300	1217	235	4122	253
161	229	826	300	1221	236	4123	254
163	229	826-2	300	1227	236	4127	254
164	230	830	289	1231	236	4141	254
191	227	831	289	1237	237	4147	255
191	228	832	289	1241	237	4161	255
192	230	833	290	1247	237	4167	255
213	281	834	290	1271	241	4178	252
213U	283	835	290	1274	241	4277	252
216	281	836	291	1277	241	4301	217
216U	283	837	291	1517	193	4302	217
217	281	838	291	1520	193	4303	217
217U	284	839	292	1524	194	4831	256
222	282	840	293	1532	195	4833	256
222U	284	841	294	1536	194	4837	256
223	282	843	294	1542	195	5301	205
223U	284	844	294	1554	193	5302	205
226	282	845	295	1583	194	5303	205
226U	284	847	295	1584	194	5321	206
228	283	902	265	1621	238	5322	206
228U	285	903	265	1624	238	5326	206
229	283	904	264	1627	239	5336	206
229U	285	904-2	266	1641	239	5720	144
233	282	904-3	266	1647	239	5720MET	143
233U	285	904-4	266	1661	240	5723	144
500	224	905	265	1667	240	5723MET	143
50050AT	224	906	264	1727	190	5727	144
580	302	907	272	1727D	190	5727MET	144
580CB	302	908	264	1737	191	5801	167
581	303	909	272	1737D	191	5802	167
581CB	303	910	265	1747	190	5803	167
582	303	912	268	1757	191	5804	168
590	225	912MET	271	1831	242	5805	168
59050AT	225	913	268	1834	242	5806	168
621	222	913MET	271	1837	242	5807	171
627	222	914	267	2002	192	5809	171
631	223	914-2	269	2002-IF	192	5811	175
637	223	914-3	269	2002-OF	192	5812	175
715-CART	273	914-4	269	2003	192	5813	175
720-CART	280	914MET	270	2013	247	5814	176
720-GC	280	914MET-2	272	2016	247	5815	176
723	279	914MET-3	272	2177	247	5816	176
723BC	279	914MET-4	272	2277	248	5820	172
723SBC	280	915	268	3201	243	5821	174
723SC	279	915MET	271	3207	243	5822	174
724	279	916	267	3271	242	5823	170
724BC	280	916MET	270	3274	243	5825	172
724SBC	280	917	272	3277	243	5826	175

model	page #	model	page #	model	page #	model	page #
5827	171	5905MET	186	7301	196	9430	259
5827UA	172	5906	181	7302	196	9433	262
5828	144	5906MET	186	7303	196	9434	262
5830	168	5911	182, 188	7331	200	9435	262
5831	168	5912	182	7332	200	9500	259
5832	169	5912MET	188	7333	201	9503	262
5833	169	5913	182	7335	201	9504	262
5834	177	5913MET	188	7339L	200	9505	263
5835-IF	169	5914	182	7339R	200	9510	259
5835-OF	169	5914MET	188	7401	197	9513	263
5836	170	5920	143	7402	197	9514	263
5837	175	5920MET	142	7403	197	9515	263
5838-IF	178	5921	187	7420	197	15202	194
5843	170	5922	187	7421	197	BB	296
5844	170	5923	143	7423	197	BS	174
5848	175	5923MET	142	7424	198	CH	191
5853	170	5924	181	7425	198	DH	191
5860	168	5924MET	186	7426	198	DPS	296
5865-IF	169	5925	181	7431	199	FH	298
5865-OF	169	5925MET	186	7432	199	FT	296
5868-IF	178	5926	187	7433	199	HC	298
5874	177	5927	143	7434	199	HM	297
5875	173	5927MET	143	7435	200	HW_CT20	146
5875-IF	174	5935-IF	180	7436	200	HW_CT48	145, 206
5875L	174	5935MET-IF	185	7441	201	HW_ET18	145, 206
5875R	174	5935MET-OF	185	7442	201	HW_ET23	146
5875UAH	173	5935-OF	180	7443	201	HR751	220
5876	173	5936MET	187	8233	300	HR751G	221
5876UAH	173	5948	180	8233D	301	LPT	296
5881	178	5948MET	187	8233UD	301	MB	297
5882	178	5965-IF	180	9118	277	MT	297
5883	177	5965MET-IF	185	9120	146, 213	MTB	297
5884	178	5965MET-OF	185	9123	146, 213	NH	191
5886	178	5965-OF	180	9128	277	OX	298
5890	171	6101	207	9131	212	PA	297
5895	171	6102	207	9132	212	PB	296
5901	179	6103	207	9133	212	PL	296
5901MET	184	6201	208	9138	213	RA	298
5902	179	6202	208	9193CTC	277	T1005	232, 275
5902MET	184	6203	208	9400	258	TAL	173
5903	179	6301	209	9403	260	TAR	173
5903MET	184	6302	209	9404	260	TR_4020	147, 216, 250
5904	181	6303	209	9405	260	TR_4023	147, 216, 250
5904CL	183	6400	211	9410	258	UA	172
5904CR	183	6401	210	9413	261	UAL	172
5904CLR	183	6402	210	9414	261	UAR	172
5904MET	186	6403	210	9415	261	VT_100	146
5904MET-CL	189	6720	145, 211	9420	258	VT_110	147
5904MET-CR	189	6723	145, 211	9423	261	VT_120	147
5904MET-CLR	189	6730	145	9424	261		
5905	181	6733	145	9425	261		

Environmental and Sustainability Efforts

For almost 60 years, HPFI® (High Point Furniture Industries) has been building furniture in the United States with respect to our environment and our community. As a world-class manufacturer, we strive to reduce and eliminate our impact on the environment. We recycle and reuse wherever possible. When viable and acceptable to our customers, we incorporate recycled and recyclable materials into our finished products.

HPFi uses level®, BIFMA’s sustainability certification program for furniture. This standard is used to identify and certify the levels of environmental achievement as well as identify specific contributions of LEED points. All certified HPFI products have been certified to level 2 by SCS Global Services.

Our sustainability efforts extend beyond the materials and processes involved in the manufacture and fabrication of our products. We also address end-of-life opportunities for our furniture. Additionally, our efforts involve social responsibility with HPFI associates as well as our business partners.

For additional information and the most up to date details, visit http://www.hpfi.com/about_sustainability_overview.php.



All HPFi® certified products are certified to level® 2. level, BIFMA's sustainability certification program for furniture, is a comprehensive and transparent third-party certification program. The level mark attests that the product, our manufacturing facilities and our company have been evaluated against the multi-attribute criteria of the ANSI/BIFMA e3 Furniture Sustainability Standard.

